

# M-CASTER LIVE

**Portable Live Streaming Mixer**

**OWNER'S MANUAL**



## Important Safety Instructions

1. Read these instructions.
2. Keep these instructions.
3. Heed all warnings.
4. Follow all instructions.
5. Do not use this apparatus near water.
6. Clean only with a dry cloth.
7. Do not block any ventilation openings.  
Install in accordance with the manufacturer's instructions.
8. Minimum distance (5 cm) around the apparatus for sufficient ventilation.  
The ventilation should not be impeded by covering the ventilation openings with items, such as newspapers, table-cloths, curtains, etc.
9. Do not install near any heat sources such as radiators, heat registers, stoves, or other apparatus (including amplifiers) that produce heat.
10. No naked flame sources, such as lighted candles, should be placed on the apparatus.
11. Protect the power cord from being walked on or pinched particularly at plugs, convenience receptacles, and the point where they exit from the apparatus.
12. Only use attachments/accessories specified by the manufacturer.
13. Use only with a cart, stand, tripod, bracket, or table specified by the manufacturer, or sold with the apparatus.  
When a cart is used, use caution when moving the cart/apparatus combination to avoid injury from tip-over.
14. Unplug this apparatus during lightning storms or when unused for long periods of time.
15. Refer all servicing to qualified service personnel. Servicing is required when the apparatus has been damaged in any way, such as power-supply cord or plug is damaged, liquid has been spilled or objects have fallen into the apparatus, the apparatus has been exposed to rain or moisture, does not operate normally, or has been dropped.
16. This apparatus shall not be exposed to dripping or splashing, and no object filled with liquids, such as vases or beer glasses, shall be placed on the apparatus.
17. Do not overload wall outlets and extension cords as this can result in a risk of fire or electric shock.
18. The use of apparatus is in moderate climates. [113 °F / 45 °C maximum].
19. **NOTE:** This device complies with Part 15 of the FCC Rules [and contains license-exempt transmitter(s)/receiver(s) that comply with Innovation, Science and Economic Development Canada's license-exempt RSS(s)]. Operation is subject to the following two conditions:
  - (1) this device may not cause harmful interference, and
  - (2) this device must accept any interference received, including interference that may cause undesired operation.



L'émetteur/récepteur exempt de licence contenu dans le présent appareil est conforme aux CNR d'Innovation, Sciences et Développement économique Canada applicables aux appareils radio exempts de licence. L'exploitation est autorisée aux deux conditions suivantes:

- (1) l'appareil ne doit pas produire de brouillage, et
- (2) l'appareil doit accepter tout brouillage radioélectrique subi, même si le brouillage est susceptible d'en compromettre le fonctionnement.

**CAUTION:** Changes or modifications to this device not expressly approved by LOUD Audio, LLC. could void the user's authority to operate the equipment under FCC rules.

20. This apparatus does not exceed the Class B limits for radio noise emissions from digital apparatus as set out in the radio interference regulations of the Canadian Department of Communications.

Canada ICES-003(B)/NMB-003(B)

**ATTENTION** — *Le présent appareil numérique n'émet pas de bruits radioélectriques dépassant les limites applicables aux appareils numériques de class A/de class B (selon le cas) prescrites dans le règlement sur le brouillage radioélectrique édicté par les ministere des communications du Canada.*

21. Exposure to extremely high noise levels may cause permanent hearing loss. Individuals vary considerably in susceptibility to noise-induced hearing loss, but nearly everyone will lose some hearing if exposed to sufficiently intense noise for a period of time. The U.S. Government's Occupational Safety and Health Administration (OSHA) has specified the permissible noise level exposures shown in the following chart.

According to OSHA, any exposure in excess of these permissible limits could result in some hearing loss. To ensure against potentially dangerous exposure to high sound pressure levels, it is recommended that all persons exposed to equipment capable of producing high sound pressure levels use hearing protectors while the equipment is in operation. Ear plugs or protectors in the ear canals or over the ears must be worn when operating the equipment in order to prevent permanent hearing loss if exposure is in excess of the limits set forth here:

Duration, per day in hours	Sound Level dBA, Slow Response	Typical Example
8	90	Duo in small club
6	92	
4	95	Subway Train
3	97	
2	100	Very loud classical music
1.5	102	
1	105	The roar of Snoqualmie Falls.
0.5	110	
0.25 or less	115	Loudest parts at a rock concert

**WARNING** — To reduce the risk of fire or electric shock, do not expose this apparatus to rain or moisture.

Laitte on liitettävä suojakoskettimilla varustettuun pistorasiaan.

Apparatet stikprop skal tilsluttes en stikkontakt med jord, som giver forbindelse til stikproppens jord.

Apparatet må tilkoples jordet stikkontakt.

Apparaten skall anslutas till jordat uttag.



**Correct disposal of this product:** This symbol indicates that this product should not be disposed of with your household waste, according to the WEEE directive (2012/19/EU) and your national law. This product should be handed over to an authorized collection site for recycling waste electrical and electronic equipment (EEE). Improper handling of this type of waste could have a possible negative impact on the environment and human health due to potentially hazardous substances that are generally associated with EEE. At the same time, your cooperation in the correct disposal of this product will contribute to the effective usage of natural resources. For more information about where you can drop off your waste equipment for recycling, please contact your local city office, waste authority, or your household waste disposal service.

## Contents

- Important Safety Instructions .....2
- Contents .....3
- Features.....3
- Introduction .....4
- Getting Started .....4
- Hookup Diagrams .....5
- M•Caster LIVE: Side Panel Features .....7**
  - 1. USB-C Power Connection .....7
  - 2. 48V Phantom Power Switch [XLR] .....7
  - 3. Mic Input [Ch. 1] .....7
  - 4. 1/8" Headset Output [Ch. 1].....7
  - 5. USB I/O [Ch. 2] .....8
  - 6. 1/8" Instrument / Line In Jack [Ch. 2] ...8
  - 7. 1/8" Smartphone St. In Jack [Ch. 3].....8
  - 8. 1/8" Headphones Output Jack.....8
  - 9. 1/8" Speaker Output Jack.....8
- M•Caster LIVE: Top Panel Features.....9**
  - 10. Volume Knobs.....9
  - 11. Input Selector Switches .....9
  - 12. ContourFX Preset Selector .....9
  - 13. ContourFX Control Knobs .....9
  - 14. StreamFX Preset Selector.....10
  - 15. StreamFX Control Knobs.....10
  - 16. Master Location Selector.....10
  - 17. Location Control Knobs.....10
  - 18. Master Century Selector .....10
  - 19. Decade and Year Control Knobs .....10
  - 20. Main Mix Volume Knob .....10
  - 21. LED Color Selector Switch .....10
- Appendix A: Service Information .....11
- Appendix B: Technical Information ..... 12
- M•Caster LIVE Dimensions .....12
- M•Caster LIVE Block Diagrams ..... 13
- Limited Warranty ..... 14

## Features

**Connect directly to your smartphone's headphone jack to both send and receive audio**

**Pristine sound quality and unmatched flexibility in an ultra-compact design**

**Connect your favorite mic, headset, and more**

**Pick the perfect vocal sound with selectable ContourFX Presets**

**StreamFX makes it easy to add the finishing touch with fun voice-changing effects**

**RGB LED strip with 7 user-selectable colors**

**USB connectivity allows for use as an audio interface on a Mac/PC**

### Included accessories

- USB Cable
- 1/8" TRS / Aux Cable
- 1/8" TRRS Cable (For Smartphones)
- Power Supply

**Please write the serial numbers here for future reference (i.e., insurance claims, tech support, return authorization, make dad proud, etc.)**

**Purchased at:**

**Date of purchase:**



Part No. SW1337 Rev. C 04/22

©2022 LOUD Audio, LLC. Allright Allright All Rights Reserved.

## Introduction

M•Caster Live is the ultimate portable audio solution for streaming on mobile devices.

Plug in your mic, sweeten your sound with ContourFX and StreamFX, then stream in minutes. With ContourFX, your voice will reach new heights with studio-quality sound-shaping and enhancements. And with StreamFX, you can add fun voice changing effects.

M•Caster Live is also packed with features like dedicated headset and media player inputs, USB connectivity, and user-selectable RGB lighting that looks amazing in any streaming setup.

On the go? Just plug in an external USB battery and you have an incredible mobile streaming platform.

From streaming to podcasting, get pristine audio just about anywhere with M•Caster Live. Your followers will thank you.

### How to Use This Manual:

After this introduction, a getting started guide will help you get things set up fast. The hookup diagrams show some typical setups, while the remaining sections provide details of the M•Caster Live.

The bracketed numbers throughout the manual references the number of each of the features; go there if you seek additional information about said feature.



This icon marks information that is critically important or unique to the M•Caster Live. For your own good (and our peace of mind), please read and remember them. You will be quizzed later.



There's an illustration of a microscope, so, of course, you're going to get more detailed information when you see this little guy. There are explanations of features and practical tips listed here.



It's a good idea to pay attention to text displayed next to a note icon, as this icon draws attention to certain features and functions relating to the usage of the M•Caster Live.

## Getting Started

We realize that you can't wait to hook up your M•Caster Live and try it out. Nevertheless, please take the time to read this page NOW, and the rest can wait until you're good and ready.

1. Turn down all knobs.
2. Connect a power adapter (USB or wall-wart) or portable power bank to the power connector.
3. Connect to headphones and/or to speakers.
4. Plug signal sources into the M•Caster Live, such as:
  - Microphone plugged into the mic input. (Engage phantom power if needed.)
  - Line-level sources such as a keyboard, headset and/or smartphone plugged into the line-level inputs.
  - Computer plugged into the USB-C jack.
5. Confirm that the input selector switches have the correct inputs selected.
6. Slowly raise the input and output volume knobs to a comfortable listening level.
7. Add FX, contour shaping and downlit accent color to taste.

If you desire a more thorough walk-through of the M•Caster Live, there is a wealth of information in the following pages!

### Additional Tidbits of Wisdom

- Never listen to loud music for prolonged periods. Please see the Safety Instructions on page 2 for information on hearing protection.
- Beep boop.
- Save the sales receipt and original packaging in case you ever need warranty service.

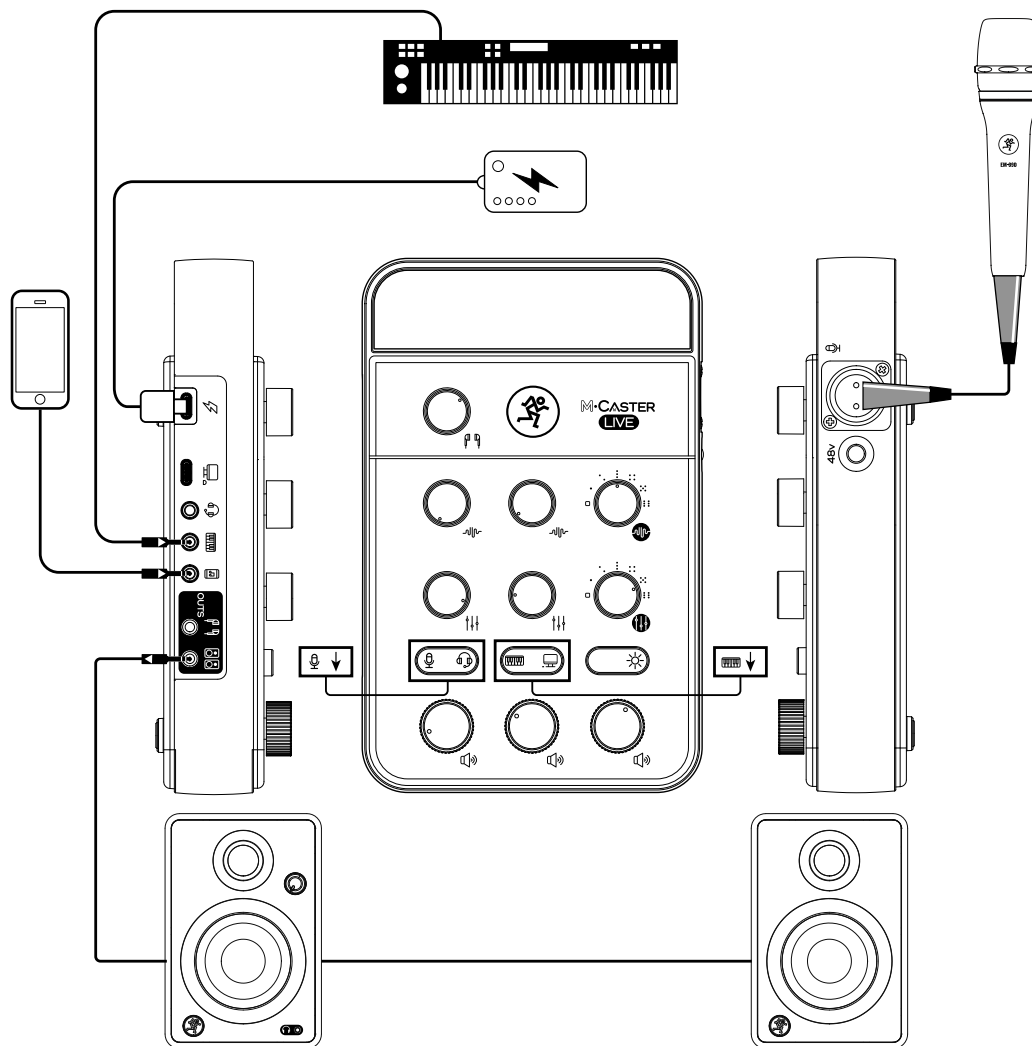

There are a number of use case scenarios for M•Caster Live. Live streamers use their favorite device (phone or tablet) as the connection to the streaming service, game streamers often stream-share live video and their game screens over Twitch and other social platforms and M•Caster Live works well for podcasters due to its portability and remote power (not to mention quality audio and fun effects).

In this example, a Mackie EM-89D microphone is connected to the channel 1 XLR mic input [#3]. Add phantom power if needed [#2]. The left side of channel 1's input selector switch should be illuminated. A keyboard or sampler is added to the channel 2 1/8" input [#6]. The left side of channel 2's input selector switch should be illuminated. Lastly, a phone connects to the 1/8" TRRS connector in order to send and receive signal.

As shown above, a pair of Mackie's CR-XBT monitors are connected to the M•Caster Live's 1/8" stereo output jack [#9]. M•Caster LIVE is powered utilizing a portable power box [#1].

Adjust the input [#10] and output [#20] volume of all three inputs until you are pleased with the results, then start streaming, podcasting or live journaling/newscasting!

Hookup Diagrams continued...

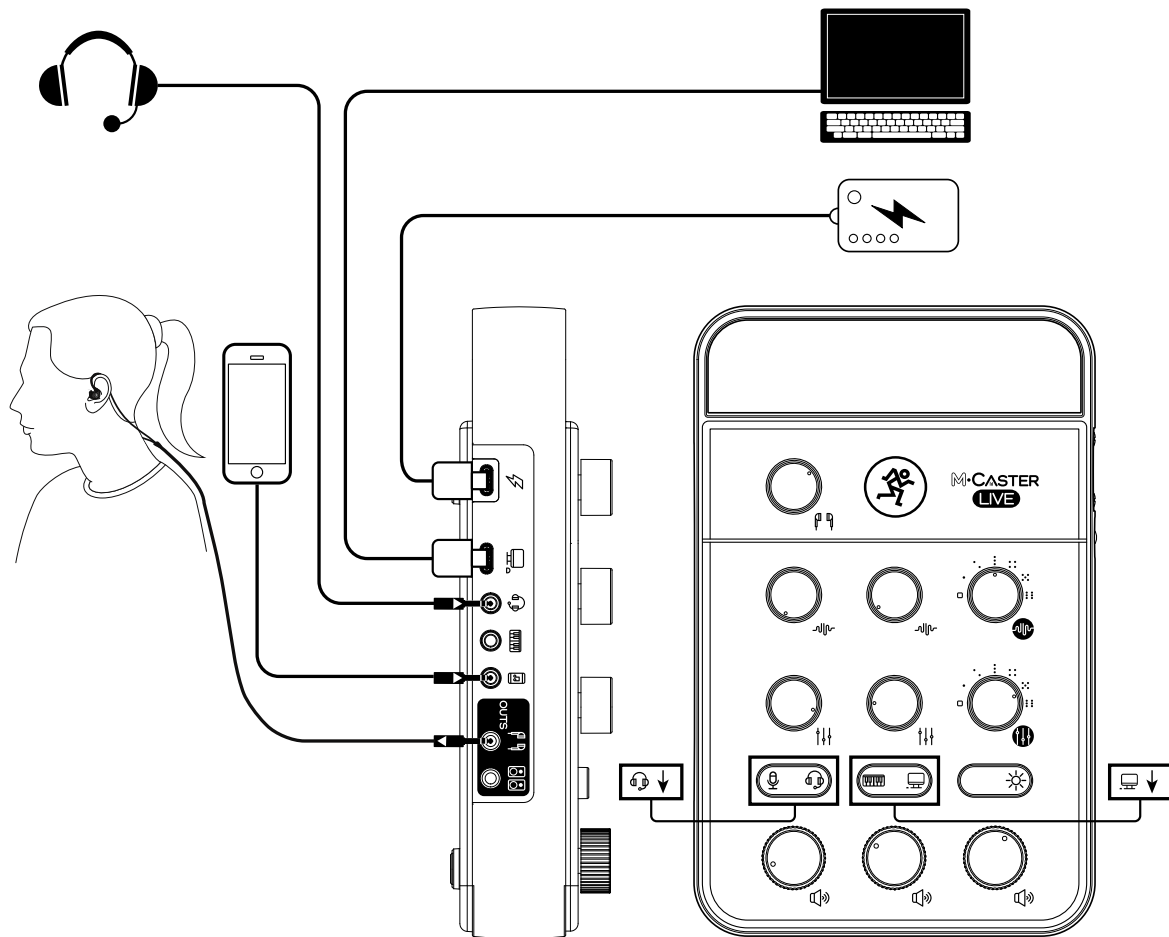

It was mentioned on the previous page that there are a number of use case scenarios for M•Caster Live. With this example, we'll take a look at the other inputs and outputs.

Here, a gaming headset is connected to the channel 1 1/8" input [#4]. The right side of channel 1's input selector switch should be illuminated. A gaming computer is added to the channel 2 USB-C connector [#5]. The right side of channel 2's input selector switch should be illuminated. Lastly, a phone connects to the 1/8" TRRS connector in order to send and receive signal.

As shown above, a pair of Mackie's MP-240 in-ear monitors are connected to the M•Caster Live's 1/8" stereo headphones output jack [#8]. M•Caster Live is powered utilizing a portable power box [#1].

Adjust the input [#10] and output [#20] volume of all three inputs until you are pleased with the results, then start streaming, podcasting or live journaling/newscasting!

Live-Streaming, Game-Streaming, Podcasting and More!

# M•Caster LIVE: Side Panel Features

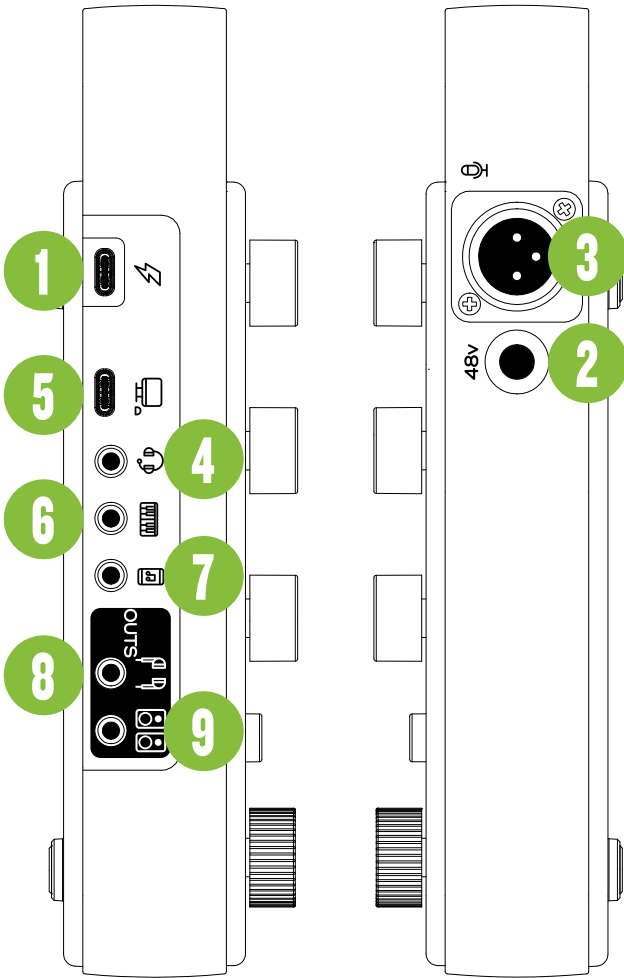

## 1. USB-C Power Connection

This is a standard USB-C power connector. The M•Caster Live may be powered in one of two ways.

Either: (1) Connect the USB-C side of the detachable power cord (included in the packaging) to the M•Caster Live and plug the other end of the power cord into a standard USB-A connector, or...

(2) Connect the USB-A side of the detachable power cord to the external "wall wart" (both included in the packaging). From there, connect the USB-C side of the power cord to the M•Caster Live and plug the other end of the power cord into a live AC outlet.



M•Caster Live does NOT power up via the computer's USB-C connection (#5). That is a separate feature!

## 2. 48V Phantom Power Switch [Ch. 1 XLR]

Press this switch in if the Ch. 1 XLR microphone requires phantom power. (Always check the position of this switch before connecting microphones.)

## 3. Mic Input [Ch. 1]

This is a female XLR connector that accepts a balanced mic or line level input from almost any type of source. The volume is controlled with the volume knobs [#10, #20].

Professional ribbon, dynamic, and condenser mics all sound excellent through this input. The mic / line input will handle any kind of level you can toss at them, without overloading.

They are wired as follows, according to standards specified by the AES (Audio Engineering Society).

### XLR Balanced Wiring:

- Pin 1 = Shield (ground)
- Pin 2 = Positive (+ or hot)
- Pin 3 = Negative (- or cold)

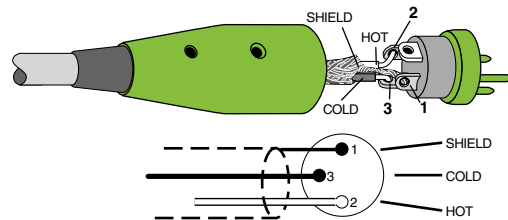

## 4. 1/8" Headset Output [Ch. 1]

This is a female 1/8" TRRS connector that accepts a line-level signal from a gaming headset. The volume is controlled with the volume knobs [#10, #20].



**Warning:** The headset amp is loud and could cause permanent hearing damage. Even intermediate levels may be painfully loud with some headsets.

**BE CAREFUL!** Always turn the volume knob all the way down before connecting headsets. Then turn it up slowly as you listen carefully.



While channel 1's XLR mic output supports 48V phantom power, this 1/8" mic output does not.

## Side Panel features continued...

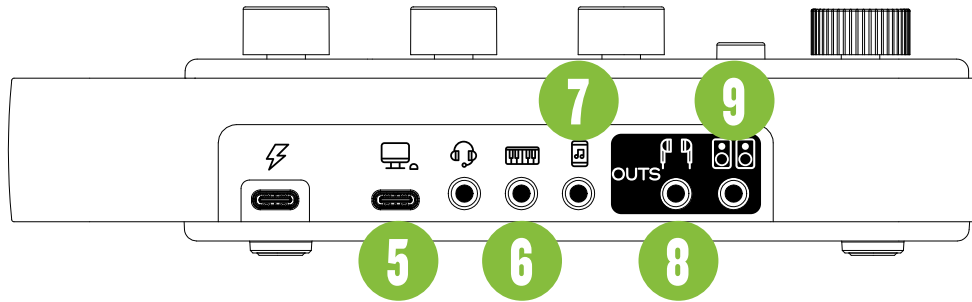

### 5. USB I/O [Ch. 2]

This is an interface that allows audio to stream to and from the M•Caster Live via computer.

This is the connection that may be used for gaming, playing uploaded and/or downloaded streaming content, playing music or just about any other sound that is emitted to/from the computer. The volume is controlled with the volume knobs [#10, #20].

Connect the USB-C side of a USB cable (included in the packaging) to the M•Caster Live and the USB-A side to the computer's USB port.

Don't forget to change the input and output to 'M•Caster Live' via Settings on your computer.



M•Caster Live's USB connection is audio only. It is not a source of power.

### 6. 1/8" Instrument / Line Input Jack [Ch. 2]

Connect a line-level signal to this input jack using an unbalanced 1/8" TRS connector (included in the packaging). This may be an instrument connection, such as a sampler or keyboard (or other), or perhaps a secondary portable source, such as another smartphone, MP3 player or just about any other line-level signal. The volume is controlled with the volume knobs [#10, #20].

It is wired as follows, according to standards specified by the AES (Audio Engineering Society):

#### Stereo 1/8" TRS

Sleeve = Shield (Ground)  
Tip = Left Channel  
Ring = Right Channel



If connecting a device, keep in mind that while the volume may be raised and lowered via the M•Caster Live volume knobs, the volume of the device also needs to be up.

### 7. 1/8" Smartphone Stereo Input Jack [Ch. 3]

Connect a line-level signal from a smartphone, MP3 player or other signal source to this input jack using an unbalanced 1/8" TRRS connector (included in the packaging). The volume is controlled with the volume knobs [#10, #20].

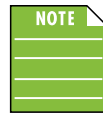

While the volume may be raised and lowered via the M•Caster Live volume knobs, the volume of the device also needs to be up.

### 8. 1/8" Headphones Output Jack

This 1/8" TRS connector supplies the output to stereo earbuds, headphones or IEMs. The volume is controlled with the main mix volume knob [#20].

The phones output is wired as follows, according to standards specified by the AES (Audio Engineering Society):

#### Stereo 1/8" TRS

Sleeve = Shield (Ground)  
Tip = Left Channel  
Ring = Right Channel



**Warning:** The headphone amp is loud and could cause permanent hearing damage. Even intermediate levels may be painfully loud with some headphones. **BE CAREFUL!**

Always turn the volume knob all the way down before connecting headphones. Then turn it up slowly as you listen carefully.

### 9. 1/8" Speaker Output Jack

This 1/8" stereo output jack connects to the input of powered monitors. The signal at this output is a direct copy of the input signal.

It shouldn't come as any surprise that we would highly recommend any sized CR-X / CR-XBT monitors. Check the Mackie website for more information!



## M-Caster LIVE: Top Panel Features

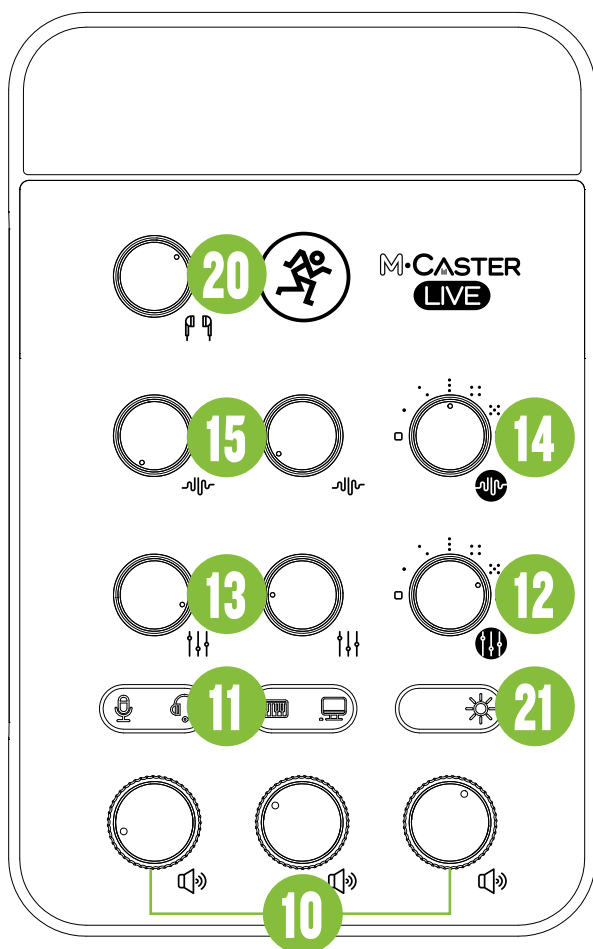

### 10. Volume Knobs

These knobs adjust the level of each channel's relative volume and gain – *of the selected source(s)* [#11] – to the main mix [#20]. This allows signals from the outside world to be adjusted to run through each channel at optimal internal operating levels. The volume levels range from  $-\infty$  dB (off) to +16.0 dB (max).

- Left knob = Ch. 1 (XLR or headset)
- Middle knob = Ch. 2 (Line input or computer/USB)
- Right knob = Ch. 3 (Phone)

### 11. Input Selector Switches

These source switches determine which channel inputs are active.

The activated channel 1 input may either be mic 1 (XLR mic, left side of Ch. 1 input selector switch down) [#2] or mic 2 (1/8" gaming headset, right side of Ch. 1 input selector switch down) [#4].

The activated channel 2 input may either be aux 1 (1/8" instrument / line input jack, left side of Ch. 2 input selector switch down) [#6] or USB (computer connection, right side of Ch. 2 input selector switch down) [#5].

The icon of the currently selected input will illuminate white.

### 12. ContourFX Preset Selector

Rotate the ContourFX preset selector to choose between seven different digital signal processors (DSPs), such as EQ, compression, filtering and more. The "audio quality enhancement" is chosen with this knob, but the amount of processing is determined by the level of the channel's ContourFX Control Knob [#13].

Only one ContourFX preset may be selected at a time. We implore you to use trial-and-error to find the best ContourFX preset for your application.

### 13. ContourFX Control Knobs

These knobs control how much the selected preset [#12] affects the channel's signal, thereby "shaping" it. The FX level ranges from off (knob fully counter-clockwise) to max (knob fully clockwise). These control knobs are post-volume [#10], but pre-StreamFX control knobs [#15].

### 14. StreamFX Preset Selector

Rotate the StreamFX preset selector to choose between seven different, crazy signal-altering effects! The effect is chosen with this knob, but the intensity of the effect is determined by the level of the channel's StreamFX Control Knob [#15].

Only one StreamFX preset may be selected at a time. We implore you to use trial-and-error to find the best StreamFX preset for your application.

### 15. StreamFX Control Knobs

These knobs increase and decrease the channel's FX intensity of the selected preset [#14]. The FX level ranges from off (knob fully counter-clockwise) to max (knob fully clockwise). These control knobs are post-volume [#10] and post-ContourFX control knobs [#13].

## Top Panel features continued...

### 16. Master Location Selector

Have you ever dreamt of time travel? Of course you have! Who hasn't?! M•Caster Live affords you the opportunity to choose not only the time to travel to, but the location, as well!

Rotate the master location selector to choose between the seven continents. The continent is chosen with this knob, but the exact location may be dialed in via the rotation of the location control knobs.

### 17. Location Control Knobs

These knobs work in conjunction with the master location selector [#16]. These knobs determine the latitude and longitude. Rotate them to get the exact location you desire.

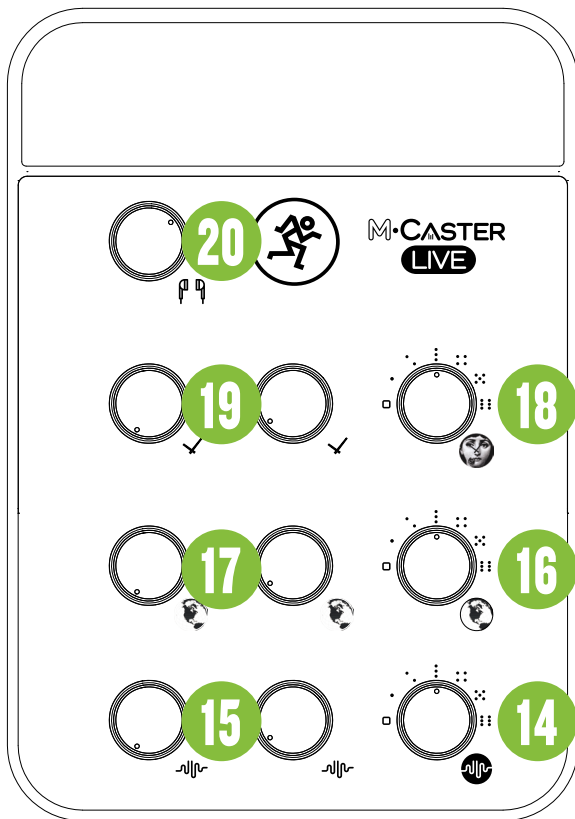

### 18. Master Century Selector

Have you ever dreamt of time travel? Of course you have! Who hasn't?! M•Caster Live affords you the opportunity to choose not only the time to travel to, but the location, as well [#16, #17]!

Rotate the master century selector to choose between the last seven centuries. The century is chosen with this knob, but the exact year may be dialed in via the rotation of the decade and year control knobs [#19].

### 19. Decade and Year Control Knobs

These knobs work in conjunction with the master location selector [#18]. These knobs set the decade and year. Rotate them to get the exact year you desire.

### 20. Main Mix Volume Knob

This knob allows you to adjust the level of the signal sent to the main outputs, including the headphones [#8] and gaming headset outputs [#4]. The volume levels range from off (silent) to max (full volume).

### 21. LED Color Selector Switch

When pressed, this cool little switch will change the downlit accent color located on the undercarriage of M•Caster Live. Simply press this switch repeatedly until the color you desire arrives. The colors available (in order) are as follows:

- None (Off)
- White
- Green
- Red
- Blue
- Yellow
- Cyan
- Purple

The "sun" icon always illuminates white regardless of the downlit color selected. Additionally, M•Caster Live will remember the selection every time it is powered up thereafter.



Don't forget to set the M•Caster Live's LED to match the carpet and drapes!

## Appendix A: Service Information

If you think your M•Caster Live has a problem, please check out the following troubleshooting tips and do your best to confirm the problem. Visit the Support section of our website ([www.mackie.com/support](http://www.mackie.com/support)) where you will find lots of useful information such as FAQs and other documentation. You may find the answer to the problem without having to part with your M•Caster Live.

### Troubleshooting

#### No power

- Please note that M•Caster Live's USB (computer) connection [#5] is audio only. It is not a source of power.
- Our favorite question: Is it plugged in? Make sure the outlet is live.
- Our next favorite question: Is the power switch on? Gotcha. There is no power switch, but...
- Make sure the power cord is plugged all the way into the AC outlet (if utilizing the wall wart). Or make sure that the USB cable is connected securely to their respective USB jacks.
- Are any of the input selector switch LEDs illuminated? If not, make sure the AC (or USB) outlet is live. If so, refer to "No sound" below.
- The internal AC line fuse may be blown. This is not a user serviceable part. If you suspect the AC line fuse is blown, please see the "Repair" section next.

#### No sound

- Do the input selector switches have the correct source(s) selected?
- Is the level knob for the input source turned all the way down? Verify that all the volume controls in the system are properly adjusted.
- Is the signal source turned up? Make sure the signal level from the computer, mixer, MP3 player, phone (or whatever device immediately precedes the M•Caster Live) is high enough to produce sound.
- Speaking of computers, if one is connected to the M•Caster Live, make sure (1) that the cable is plugged in to the correct jacks and (2) that the input and output is changed to 'M•Caster Live' via Settings on the computer.

#### Poor sound

- Is it loud and distorted? Make sure that you're not overdriving a stage in the signal chain. Verify that all level controls are set properly.
- Are the input connectors plugged completely into the jacks? Be sure all connections are secure.
- If possible, listen to the signal source with headphones plugged into the preamp stage. If it sounds bad there, it's not the M•Caster Live.

#### Noise / Hum / Buzz

- Check the signal cable between the computer/mixer/MP3 player/phone and the M•Caster Live. Make sure all connections are secure. These problems usually produce crackling noises, hum, or buzz.
- Make sure the signal cable is not routed near AC cables, power transformers, or other EMI sources (including wall warts and line lumps!). These sources usually produce hum.
- Is there a light dimmer or other triac-based device on the same AC circuit as the M•Caster Live? Dimmers cause buzzing noises. Use an AC line filter or plug the M•Caster Live into a different AC circuit (or use the USB connection instead!).
- If possible, listen to the signal source with headphones plugged in. If it sounds noisy there, it's not the M•Caster Live.

#### Other Issues

- Please email or call Technical Support if you are having any other issue(s) not listed here:
  - o [mackie.com/support-contact](http://mackie.com/support-contact)
  - o 1-800-898-3211

### Repair

For warranty service, refer to the warranty information on page 14.

Non-warranty service is available at a factory-authorized service center. To locate the nearest service center, visit [www.mackie.com/support/service-locator](http://www.mackie.com/support/service-locator). Service for an M•Caster Live living outside the United States may be obtained through local dealers or distributors.

If you do not have access to our website, please call our Tech Support department at 1-800-898-3211 (normal business hours, Pacific Time), to explain the problem. They will tell you where the nearest factory-authorized service center is located in your area.

# Appendix B: Technical Information

## M•Caster LIVE Specifications

### System Requirements

PC	Windows 10 or higher (32 or 64 MB RAM)
Android	Android 9 or higher
Mac	Mac OS X 10.8 or higher (32 or 64 MB RAM)
iOS	iOS 13 or higher

### Options

Slings Bag	P/N 2053737
------------	-------------

### Power Requirements

USB-C	100–240V, 50/60 Hz, 5V 1A 5W
Phantom Power	48VDC to Channel 1 XLR input

### Physical Dimensions and Weight

Height:	2.0 in / 52 mm
Width:	5.1 in / 129 mm
Depth:	8.0 in / 203 mm
Weight:	1.2 lb / 0.5 kg

### Disclaimer

Since we are always striving to make our products better by incorporating new and improved materials, components, and manufacturing methods, we reserve the right to change these specifications at any time without notice.

“Mackie.” and the “Running Man” figure are registered trademarks of LOUD Audio, LLC.

All other brand names mentioned are trademarks or registered trademarks of their respective holders, and are hereby acknowledged.

©2022 LOUD Audio, LLC.  
All Rights Reserved.

## M•Caster LIVE Dimensions

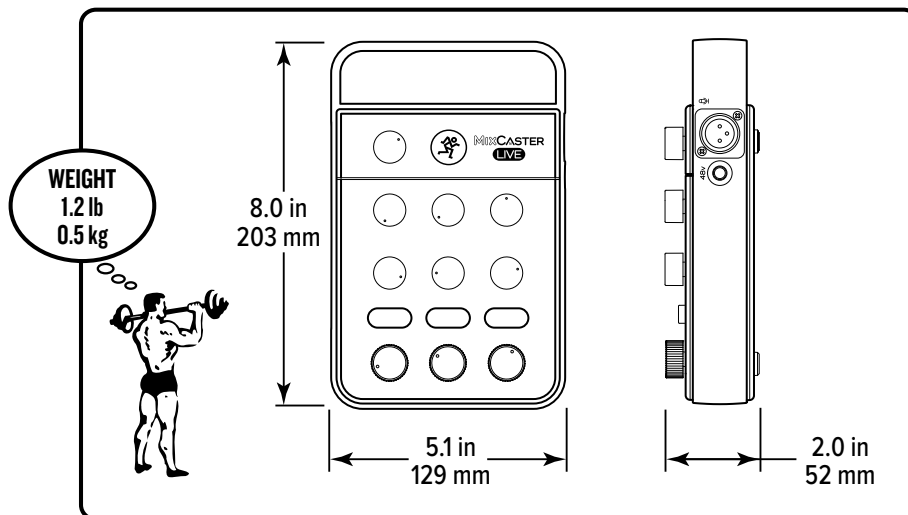

## M•Caster LIVE System Block Diagram

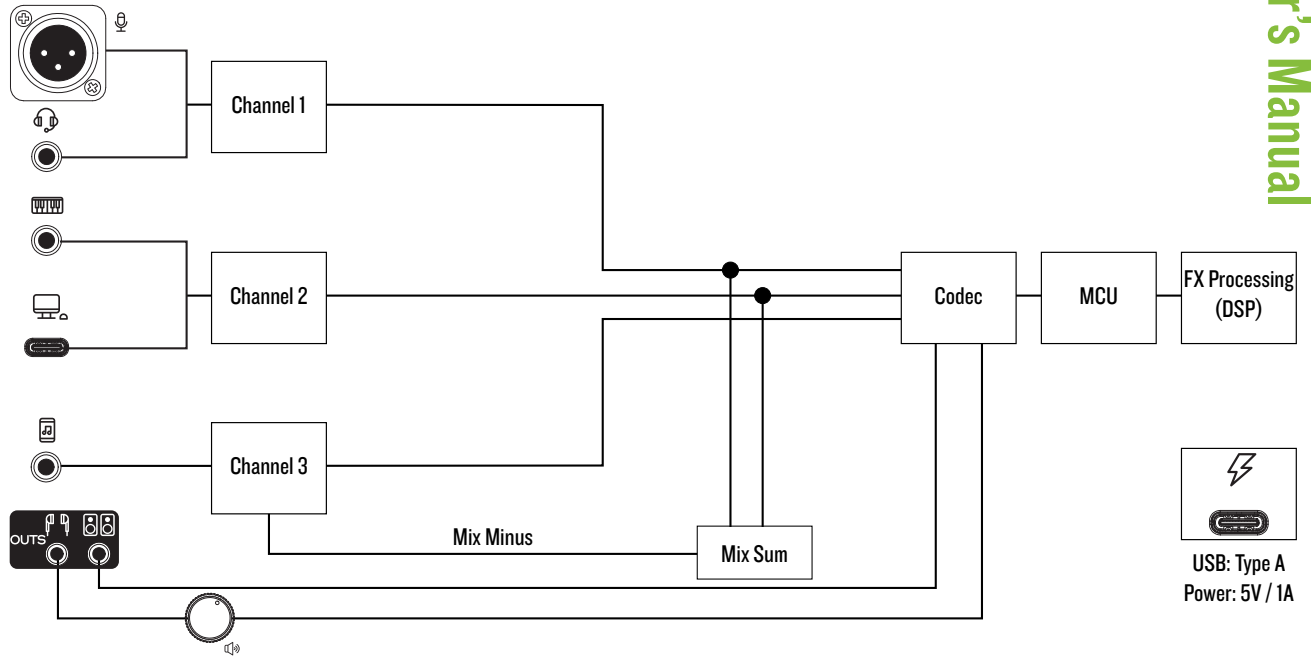

## M•Caster LIVE Channel Block Diagram

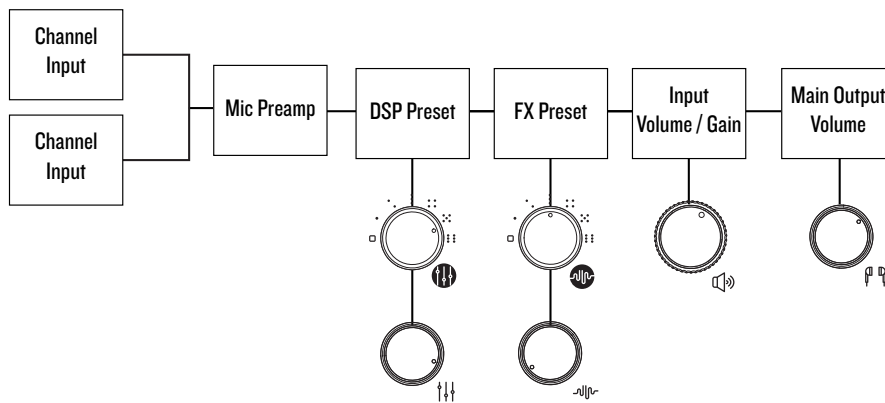

## Limited Warranty

### **Please keep your sales receipt in a safe place.**

This Limited Product Warranty (“Product Warranty”) is provided by LOUD Audio, LLC (“LOUD”) and is applicable to products purchased in the United States or Canada through a LOUD-authorized reseller or dealer. The Product Warranty will not extend to anyone other than the original purchaser of the product (hereinafter, “Customer,” “you” or “your”).

For products purchased outside the U.S. or Canada, please visit [www.mackie.com](http://www.mackie.com) to find contact information for your local distributor, and information on any warranty coverage provided by the distributor in your local market.

LOUD warrants to Customer that the product will be free from defects in materials and workmanship under normal use during the Warranty Period. If the product fails to conform to the warranty then LOUD or its authorized service representative will at its option, either repair or replace any such nonconforming product, provided that Customer gives notice of the noncompliance within the Warranty Period to the Company at: [www.mackie.com](http://www.mackie.com) or by calling LOUD technical support at 1.800.898.3211 (toll-free in the U.S. and Canada) during normal business hours Pacific Time, excluding weekends or LOUD holidays. Please retain the original dated sales receipt as evidence of the date of purchase. You will need it to obtain any warranty service.

For full terms and conditions, as well as the specific duration of the Warranty for this product, please visit [www.mackie.com](http://www.mackie.com).

The Product Warranty, together with your invoice or receipt, and the terms and conditions located at [www.mackie.com](http://www.mackie.com) constitutes the entire agreement, and supersedes any and all prior agreements between LOUD and Customer related to the subject matter hereof. No amendment, modification or waiver of any of the provisions of this Product Warranty will be valid unless set forth in a written instrument signed by the party to be bound thereby.

### **Need help with the M•Caster LIVE?**

- Visit [www.mackie.com/support](http://www.mackie.com/support) to find: FAQs, manuals, addendums, and other documents.
- Email us at: [www.mackie.com/support-contact](http://www.mackie.com/support-contact)
- Telephone 1-800-898-3211 to speak with one of our splendid technical support chaps (Monday through Friday, normal business hours, Pacific Time).



---

**19820 North Creek Parkway #201**

**Bothell, WA 98011 • USA**

**Phone: 425.487.4333**

**Toll-free: 800.898.3211**

**Fax: 425.487.4337**

**[www.mackie.com](http://www.mackie.com)**

---