



PERKONS HO-01

USER MANUAL
PERKONS HO-01



PĒRKONS HD-01

THANK YOU FOR PURCHASING THE ERICA SYNTHS PĒRKONS HD-01 DRUM SYNTHESIZER!

It's rather sudden– the bolt of lightning strikes quickly, but the roar follows behind, as if giving one time enough to inhale. Finally, it strikes your ears like the skies breaking apart and in all its magnificence it rides the wind. PĒRKONS – a deity of old known by many names and also by ours on the eastern coast of the Baltic Sea – THUNDER, lord of the skies. We at Erica Synths proudly present our newest creation – PĒRKONS (THUNDER) – a drum machine and synthesizer that will change your approach to electronic rhythm synthesis – an instrument which bears the weight of a storm beneath its sturdy casing.

PĒRKONS features four sonically versatile hybrid voices (digital sound engine + analogue multimode filter with overdrive) and a sequencer with simultaneous control over all four percussion tracks.

Each voice has 6 sound engine modes, a HP/BP/LP filter and 8 controls for nuanced sound design, including an internal BBD FX send. All voice parameter settings can be saved as KITS. To add dynamics to the performance, parameter automation is implemented and a modulation LFO can be assigned to all parameters.

For a real thunderstorm, integration with external gear is considered – each voice has a dedicated trigger input, individual output and FX send and return with 6.3mm jack sockets, along with extensive MIDI implementation. All voices are summed and run through a built-in compressor.

The PĒRKONS HD-01 is a unique live performance and sound design instrument that tears down the borders between drum machine, synthesizer and drone instrument. Time to ride the skies!

⚡ TABLE OF CONTENTS

⚡ FEATURES 4	⚡ THE INTERFACE 5	⚡ CONNECTIONS 6	⚡ THE SOUND ENGINES 7	⚡ THE TEMPO & MAIN CONTROLS SECTION 12	⚡ THE STEP SEQUENCER SECTION 17
⚡ PER STEP PLAY SETTINGS, AUTO- MATIONS AND PARAMETER LOCKS 21	⚡ PATTERN AND KIT SAVING AND RECALLING 23	⚡ PATTERN CHAINING 26	⚡ BANKS 27	⚡ MODULATION SETTINGS 28	⚡ FIRMWARE UPDATE 29
⚡ CONFIGURATION SETTINGS 30	⚡ MIDI IMPLEMENTA- TION 32	⚡ SAFETY INSTRUCTIONS 34	⚡ DISPOSAL 34		

FEATURES

- ⚡ 4 hybrid voices (digital sound engine and analogue multimode filter with overdrive)
- ⚡ 8 controls per voice
- ⚡ Trigger inputs for drum pads
- ⚡ Individual voice outputs
- ⚡ Individual sends and returns per voice
- ⚡ 64 kit and 64 pattern memory + additional memory on the SD card
- ⚡ Built-in bucket brigade delay digital emulation
- ⚡ Modulation LFO with morphing waveforms and 8 destinations
- ⚡ 4 track sequencer, 4 time divisions and 4 time multiplications per track
- ⚡ Per-step ratchets and probabilities
- ⚡ Per step parameter locks and automation recording
- ⚡ 4 groove algorithms
- ⚡ MIDI IN and MIDI OUT

WHAT'S INCLUDED

- ⚡ PĒRKONS HD-01 drum synthesizer
- ⚡ Universal 12VDC wall wart adapter
- ⚡ User manual

PĒRKONS HD-01



THE INTERFACE

PĒRKONS HD-01

THE USER INTERFACE OF THE PĒRKONS HD-01 CONSISTS OF 5 MAIN PARTS: 4 VOICES, THE MASTER SECTION, THE TEMPO AND MAIN CONTROLS, THE STEP SEQUENCER, THE MODULATION AND CONFIGURATION SECTION.

All four voices have identical control layouts, but each voice has different sound generation algorithms

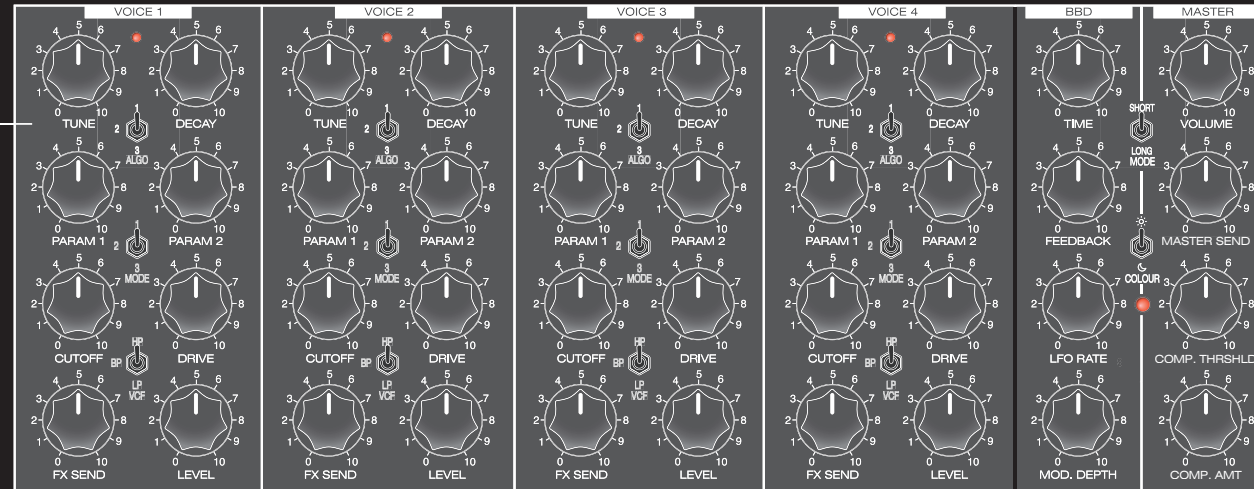

The Master section includes a built in BBD emulation with time and feedback control, as well as a dedicated modulation LFO, Master volume, Master FX send control and a Compressor with threshold/release and compression amount/gain controls

The Tempo and main controls section consists of a Master tempo control as well the main performance controls

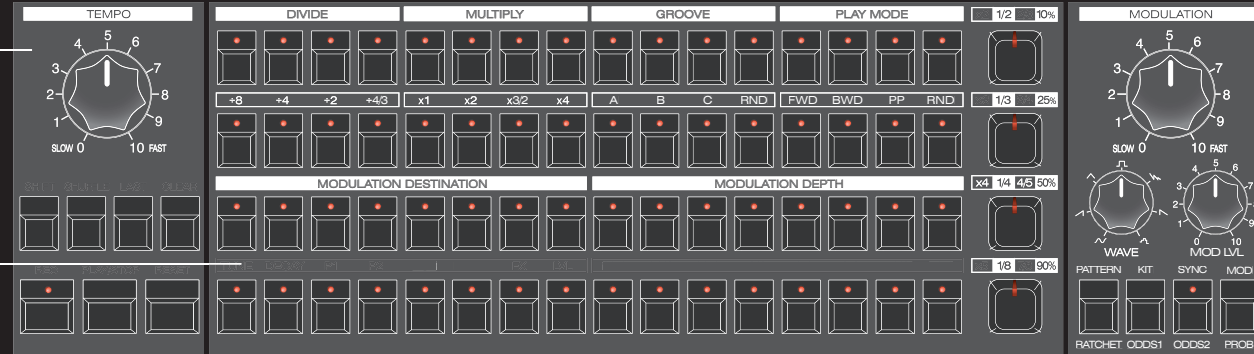

The Modulation and configuration section features the modulation LFO with tempo, waveform and master level controls, pattern and kit saving and loading, performance oriented controls, as well as access to the configuration settings

The Step sequencer provides simultaneous control over all four voices – trigger entering as well as secondary functions – time divisions and multiplications, groove settings, play mode and the modulation matrix

PĒRKONS HD-01

erica synths

In the master output section you will find a line-level master output, phones output (the level is tied to the master level), a master send output and a master return input

An SD card allows for kit and pattern saving, as well as firmware updates

Each voice has a dedicated trigger input, line level audio output and FX send and return jack sockets, so you can use different FX units or FX pedals on each voice. FX sends and returns are normalised to the built-in bucket-brigade delay emulation, so if nothing is connected to relevant sockets, the built in BBD becomes the default effect for the voices. Trigger inputs accept triggers from drum sequencers or electronic drum pads

Flip the switch to turn the PĒRKONS HD-01 on

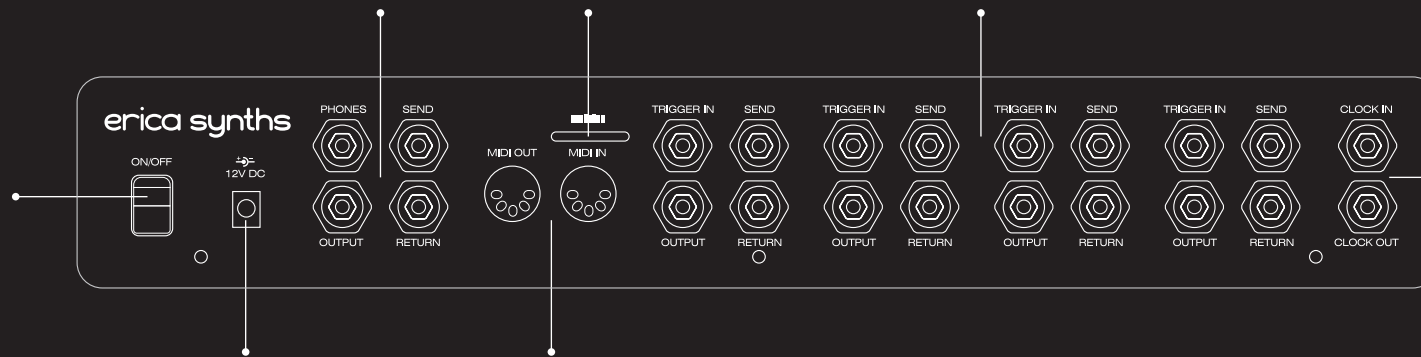

Connect the external power supply here! Use only the PSU supplied with the unit, otherwise you may risk permanent damage to your PĒRKONS HD-01

Full-size DIN5 MIDI In receives trigger note messages, MIDI clock as well as CC messages for all voice parameters. Please refer to the MIDI implementation chart in the manual. The MIDI OUT port outputs trigger and MIDI clock messages

Clock In/Out connectors are for analogue sync with external gear. The PPQ is configurable in the CONFIG settings

⚡ THE SOUND ENGINES

Each voice of the Pärkons consists of 11 identical controls – 8 potentiometers and 3 toggle switches, but the sound generation algorithms for each voice are different – please refer to the table below. Please note that all controls in the VOICE section are scanned and their positions can be saved as KITS so you can recall them and replicate the sounds you have created.

The LED on top of each voice indicates the outgoing signal of the voice.

The **ALGO switch** selects one of three sound design algorithms.

The **MODE switch** selects one of three operation modes within the selected sound design algorithm.

The **VCF switch** selects analogue voltage controlled filter (VCF) modes – highpass (HP), bandpass (BP) and lowpass (LP) respectively.

The **TUNE knob** sets the initial tune of the voice.

The **DECAY knob** sets the decay time of the percussive sound. Each voice and algorithm within the voice may have different decay time settings. Once set all the way clockwise (10) the voice turns into a drone oscillator – in the maximum decay setting the voice oscillates even if the sequencer is stopped.

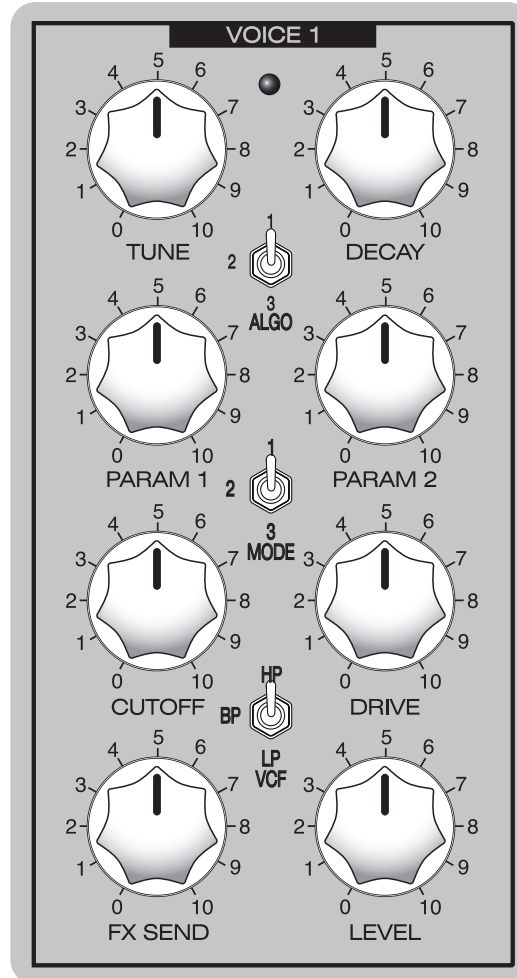

The **PARAM1** and **PARAM2** knobs control different parameters depending on the algorithm selected. Please, refer to the table below.

The **CUTOFF knob** controls the cutoff of the VCF. Please note that each VCF mode may have a different cutoff knob response. The low-pass filter will be fully open with the CUTOFF knob all way clockwise, while the high-pass filter will be fully open with the CUTOFF knob all way counter-clockwise.

The **DRIVE knob** is the Dry/Wet control for the analogue overdrive circuit – with the DRIVE knob all the way counterclockwise, the overdrive circuit is bypassed, while with the DRIVE knob all the way clockwise all signal flows through overdrive circuit and maximum overdrive is engaged.

The **FX SEND knob** determines how much of the signal is routed to any connected external FX unit or to the built in BBD if no external FX is connected.

The **LEVEL knob** sets the volume of the relevant voice.

⚡ THE SOUND ENGINES

As mentioned above, each voice of the PĒRKONS has 3 sound design algorithms with 3 modes within each algorithm.

VOICE 1

	ALGORITHM 1	ALGORITHM 2	ALGORITHM 3
NAME	FOLD DRUM 1	WAVETABLE DRUM	SIMPLE DRUM
MODE 1	no transient	wavetable 1	waveform 1
MODE 2	noise transient	wavetable 2	waveform 2
MODE 3	pulse transient	wavetable 3	waveform 3
PARAMETER 1	fold amount	surf	pitch envelope decay
PARAMETER 2	pitch envelope amount	pitch envelope amount	pitch envelope amount

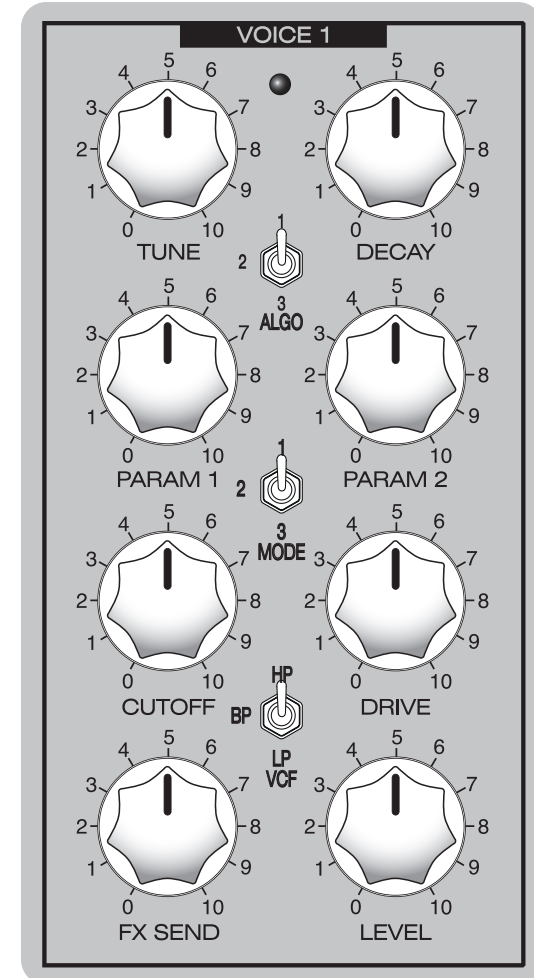

⚡ THE SOUND ENGINES

VOICE 2

	ALGORITHM 1	ALGORITHM 2	ALGORITHM 3
NAME	FOLD DRUM 2	WAVETABLE DRUM	COMPLEX DRUM
MODE 1	no transient	wavetable 1	waveform 1
MODE 2	noise transient	wavetable 2	waveform 2
MODE 3	pulse transient	wavetable 3	waveform 3
PARAMETER 1	fold amount	surf	mod osc frequency
PARAMETER 2	pitch envelope amount	pitch envelope amount	pitch envelope amount

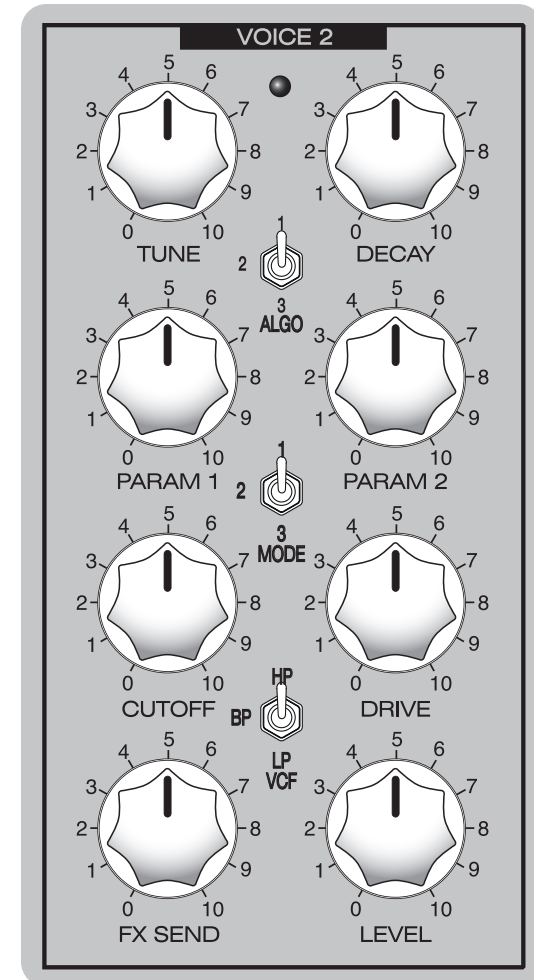

⚡ THE SOUND ENGINES

VOICE 3

	ALGORITHM 1	ALGORITHM 2	ALGORITHM 3
NAME	RESONANT DRUMS	SLAP	KARPLUS
MODE 1	resonant snare	mode 1	mode 1
MODE 2	resonant bassdrum	mode 2	mode 2
MODE 3	noise / tone drum	mode 3	mode 3
PARAMETER 1	noise tone	reverb	edge
PARAMETER 2	noise decay	crunch	twang

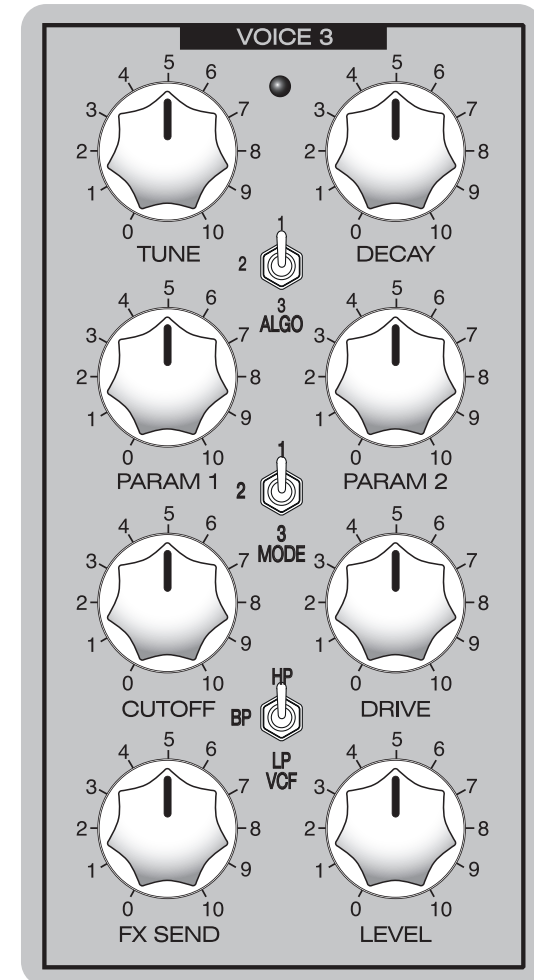

⚡ THE SOUND ENGINES

VOICE 4

	ALGORITHM 1	ALGORITHM 2	ALGORITHM 3
NAME	NOISE HAT	NOISE/TONE	ACOUSTIC HATS
MODE 1	white noise	mode 1	closed hat
MODE 2	metallic noise	mode 2	open hat
MODE 3	pulse stack noise	mode 3	ride
PARAMETER 1	envelope amount	envelope amount	sample rate
PARAMETER 2	attack	noise/tone mix	attack

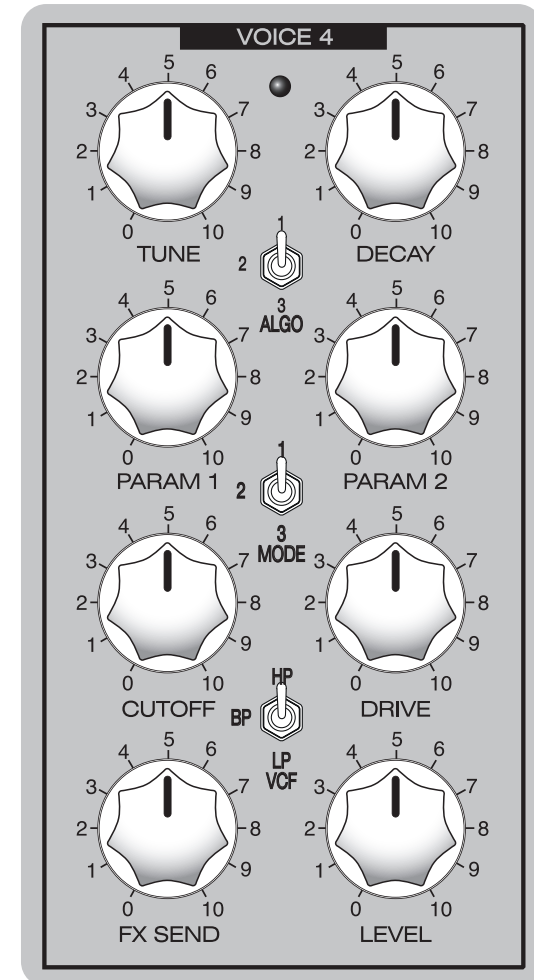

⚡ THE TEMPO & MAIN CONTROLS SECTION

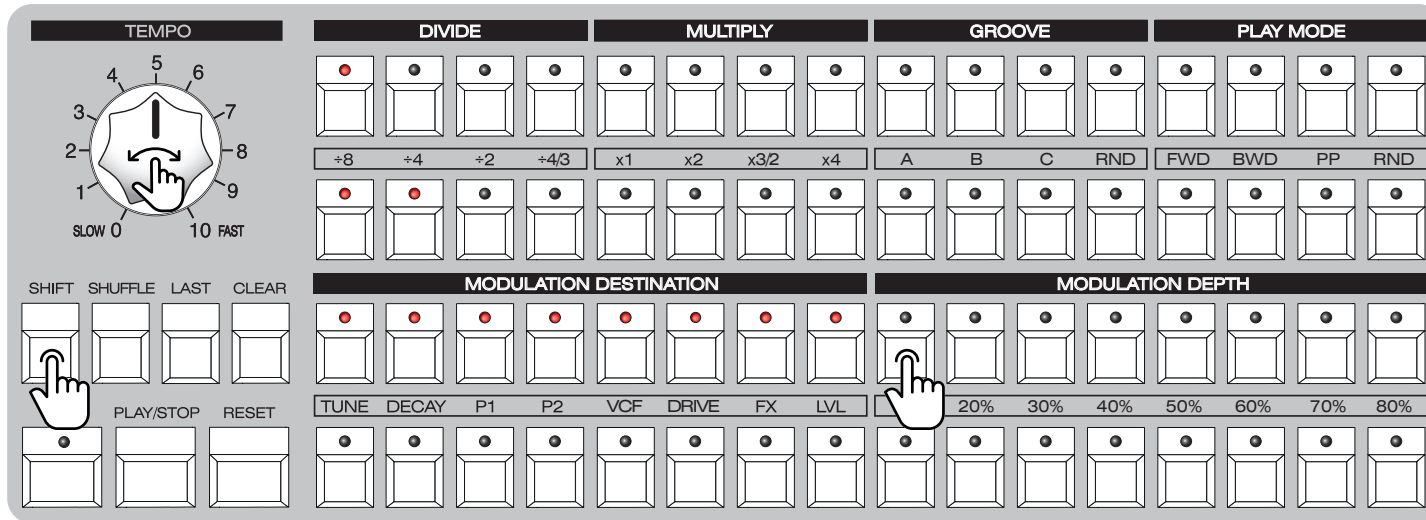

The large TEMPO knob controls the master tempo of the PÉRKONS.

In order to see what exact tempo is being played, press and hold SHIFT while turning the knob – it will indicate the tempo on three of the sequencer rows – each light on the top row represents 100 BPM, each light on the middle row represents 10 BPM and each light on the lowest row – 1 BPM.

Example to the left shows 128 BPM.

The maximum clock rate is 420 BPM and the slowest – 20 BPM. Once you release SHIFT, the PÉRKONS will exit the BPM menu.

In order to fine-tune the tempo, continue holding shift and add or remove the steps representing 1, 10 or 100 BPM by pressing them. You can also input a much slower or faster rate than the one indicated by the knob. Inputting the BPM manually will override the knob.

⚡ THE TEMPO & MAIN CONTROLS SECTION

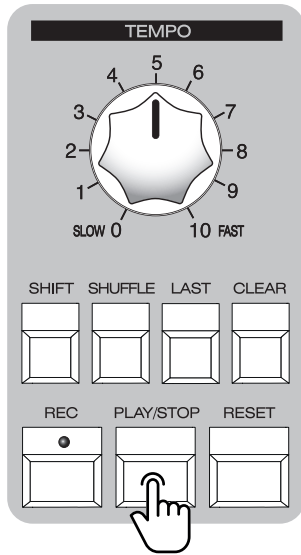

PLAY/STOP

The PLAY/STOP button is for starting and stopping the sequencer.

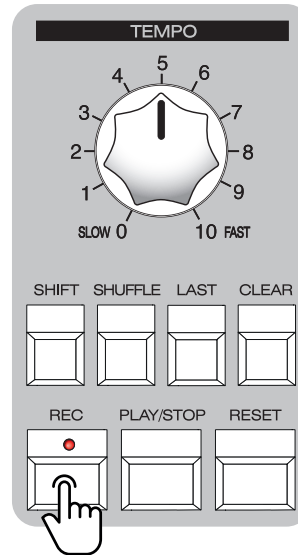

RECORD

The REC button allows for the recording of voice parameter settings. This button can either be latched by pressing once to engage/disengage or held while adjusting voice parameters and released to stop recording. Recorded parameter movements will correspond to the tempo grid, so recording movements longer than the 16-step grid is not possible.

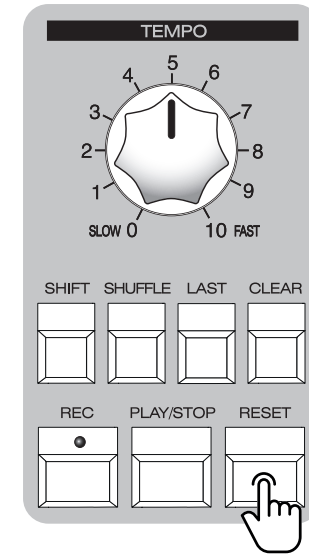

RESET

The RESET button resets the sequencer when pressed. This is useful when inputting different sequence time divisions or multiplications per voice and synchronizing them becomes necessary.

⚡ THE TEMPO & MAIN CONTROLS SECTION

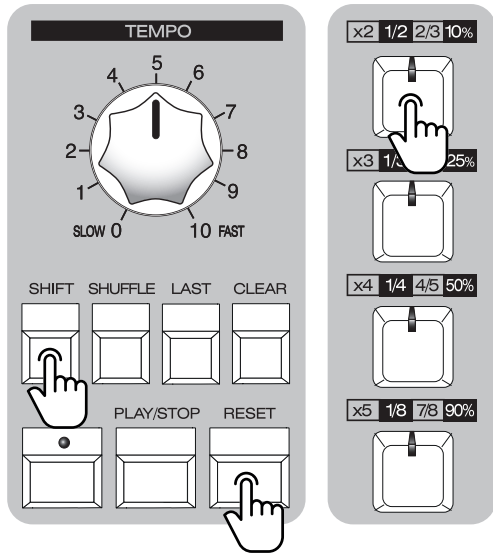

HARD RESET

You can also access more tempo controls via this button – by pressing and holding SHIFT + RESET, the voice tap keys become a set of controls for fine tempo adjustment:

The 1st tap key becomes a HARD RESET key – pressing it will re-start the internal clock which comes in handy when synchronizing the PĒRKONS with external gear or live instruments for which MIDI or analog clock sync is not possible.

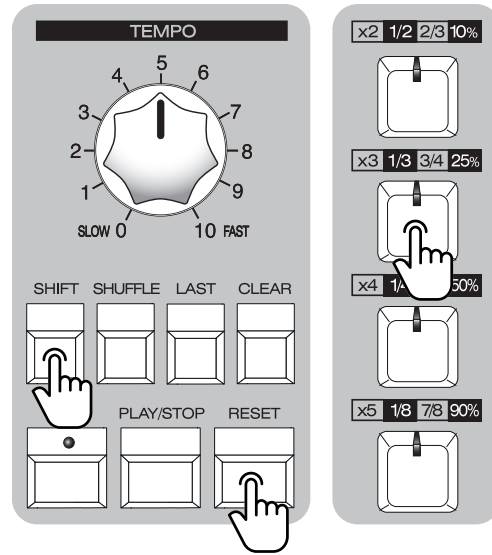

TAP TEMPO

The 2nd tap key becomes a TAP TEMPO key – tapping it once will enter the tempo fine-tuning menu (the rows of steps represent 100, 10 and 1 BPM per step) and tapping it two more times (or even more when following a tempo by listening) will set the tempo based on the tap rate – this will be displayed on the step rows. Just like fine-tuning when entering this menu with SHIFT and turning the TEMPO knob, you can manually add/remove steps to adjust to a specific BPM.

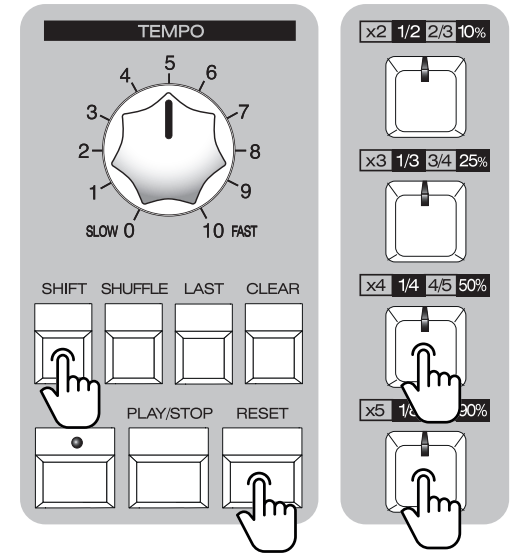

TEMPO NUDGE

The 3d and 4th keys become «nudge» keys – by pressing and holding them, they will nudge the tempo slightly forward (3d key) or back (4th key) – think of these as something similar to playing a vinyl turntable.

Releasing SHIFT and RESET will exit these additional tempo controls.

⚡ THE TEMPO & MAIN CONTROLS SECTION

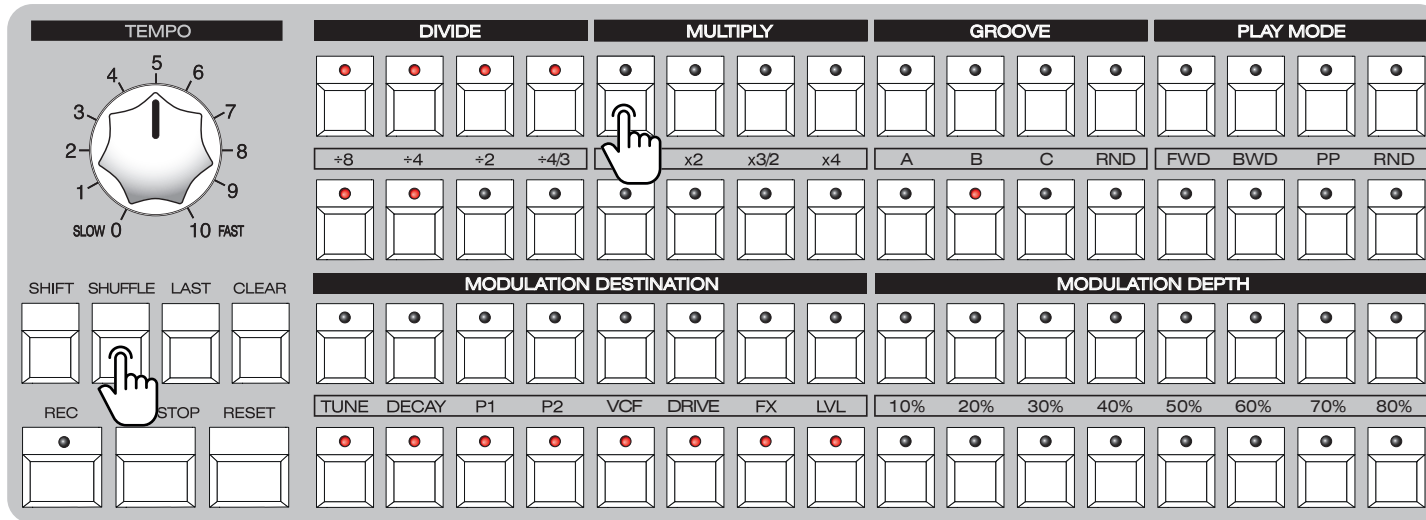

SHUFFLE SETTING

The SHUFFLE button allows for setting the shuffle amount per voice by pressing and holding it. The shuffle amount for each voice is displayed on the step grid, with the 1st step representing the minimum value and the 16th step representing the maximum value.

An example to the left shows 30% shuffle on the first voice, 10% shuffle on the second voice, no shuffle on the third voice and 50% shuffle on the fourth voice.

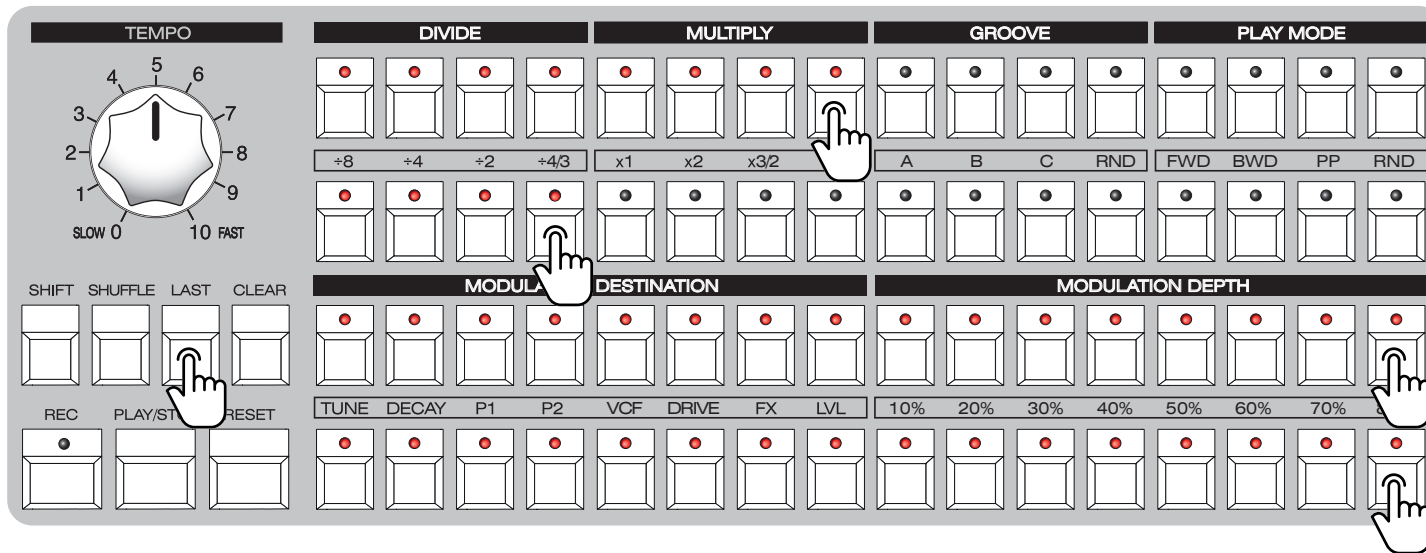

MASTER PATTERN LENGTH

If you want to chain patterns, you need to set a MASTER PATTERN LENGTH. To do so, push and hold the SHIFT and LAST buttons - you can set the master length anywhere from 1 (first step of the top sequencer row) to 64 (last step of the bottom sequencer row).

⚡ THE TEMPO & MAIN CONTROLS SECTION

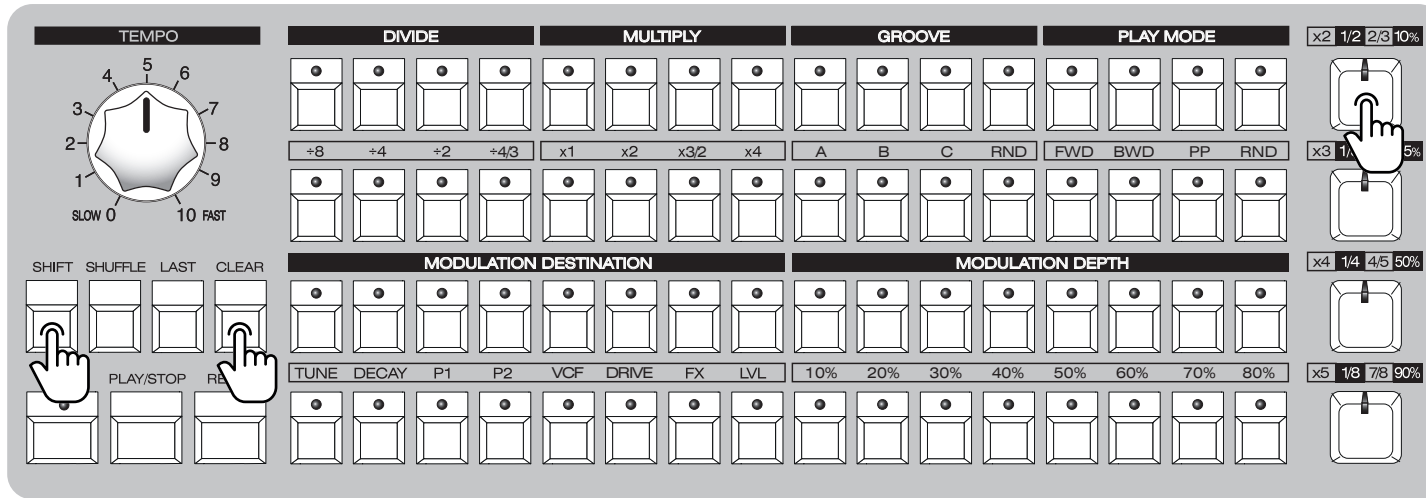

CLEAR ALL PARAMETERS AND AUTOMATIONS

The CLEAR button is for clearing the sequence for each voice as well as the recorded parameter settings. By pressing CLEAR + the corresponding tap key per-voice, the entire sequence + recorded parameter automation will be cleared. By pressing SHIFT + CLEAR + the corresponding tap key, only the recorded parameter automation will be cleared while retaining the steps (all modulations on Voice 1 are cleared in the example to the left).

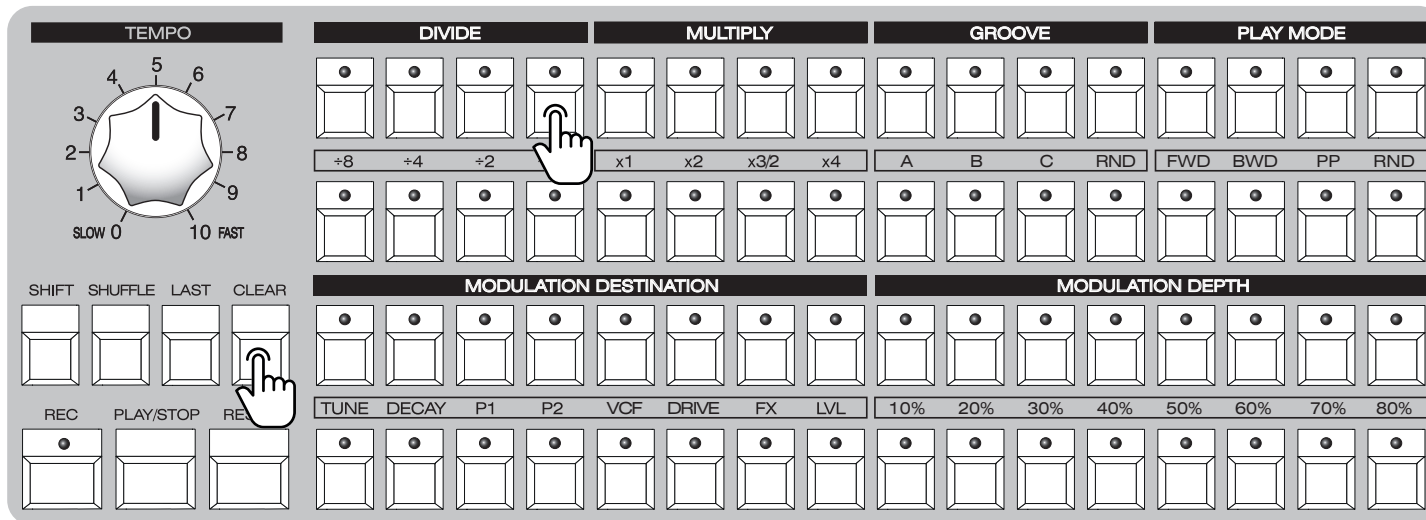

PER-STEP PARAMETER AND AUTOMATION CLEAR

You can also clear the assigned modulation when in the modulation menu – you can clear specific per step modulation destination assignments by holding a step button and pressing CLEAR (all modulations on the step 4 are cleared in the example to the left).

⚡ THE STEP SEQUENCER SECTION

The Step Sequencer provides simultaneous control over all four voices – trigger entering as well as secondary functions – time divisions and multiplications, groove settings, play mode and modulation matrix.

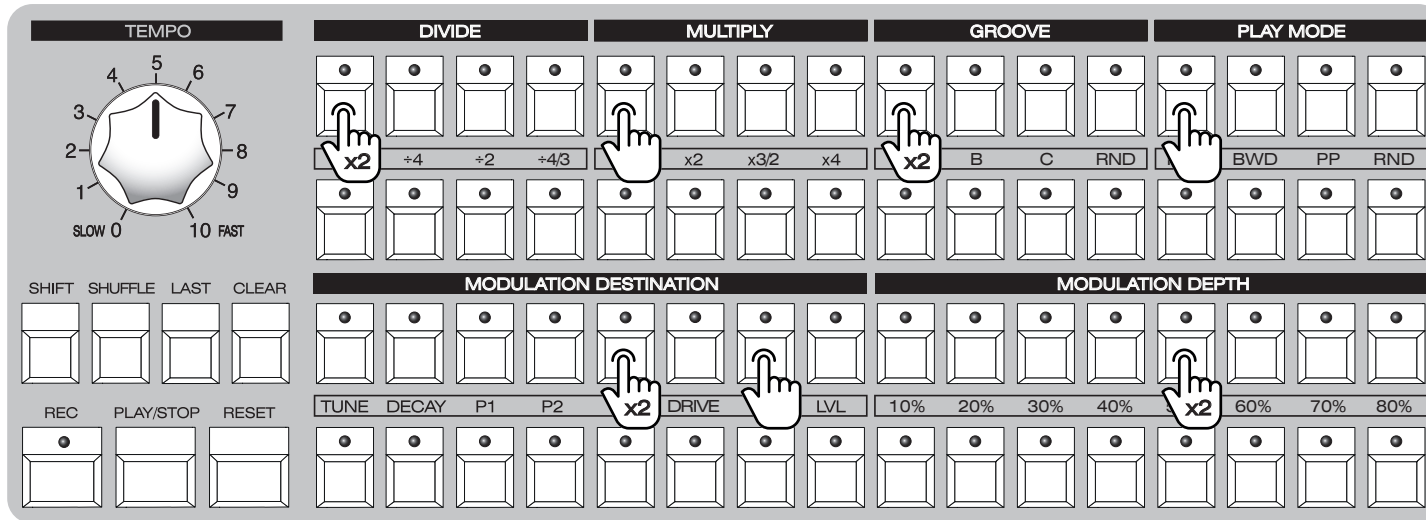

STEP PROGRAMMING

The most obvious and straight-forward feature is trigger entering. Unlike most drum machines and grooveboxes, the PĒRKONS HD-01 has a step sequencer for each voice, so you can enter triggers simultaneously for all four voices. While the sequencer is running, push the step buttons to activate triggers on each voice.

STEP ACCENTS

If accents are enabled in the configuration settings (see page 30 of the manual), you can set each step to be either accented or without accent – press a step once to activate it – it is now without an accent, press the same step again and the LED brightness increases – the step is now accented. This allows for creating more expressive sequences.

TAP PROGRAMMING

You can also do tap programming. While the sequencer is running push and hold the REC button and use TAP buttons to enter the triggers. The entered triggers will automatically quantize to the nearest 16th steps and the corresponding step LEDs will illuminate.

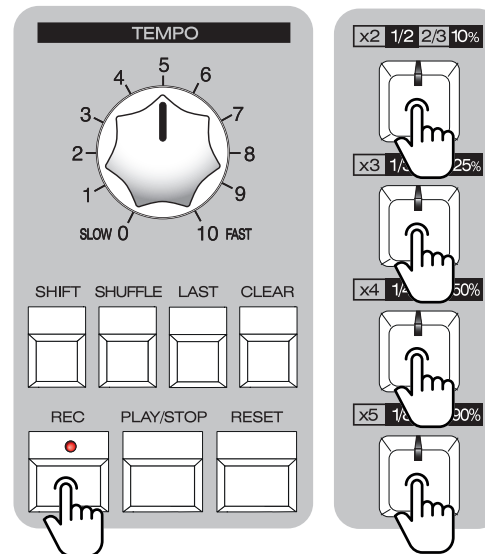

⚡ THE STEP SEQUENCER SECTION

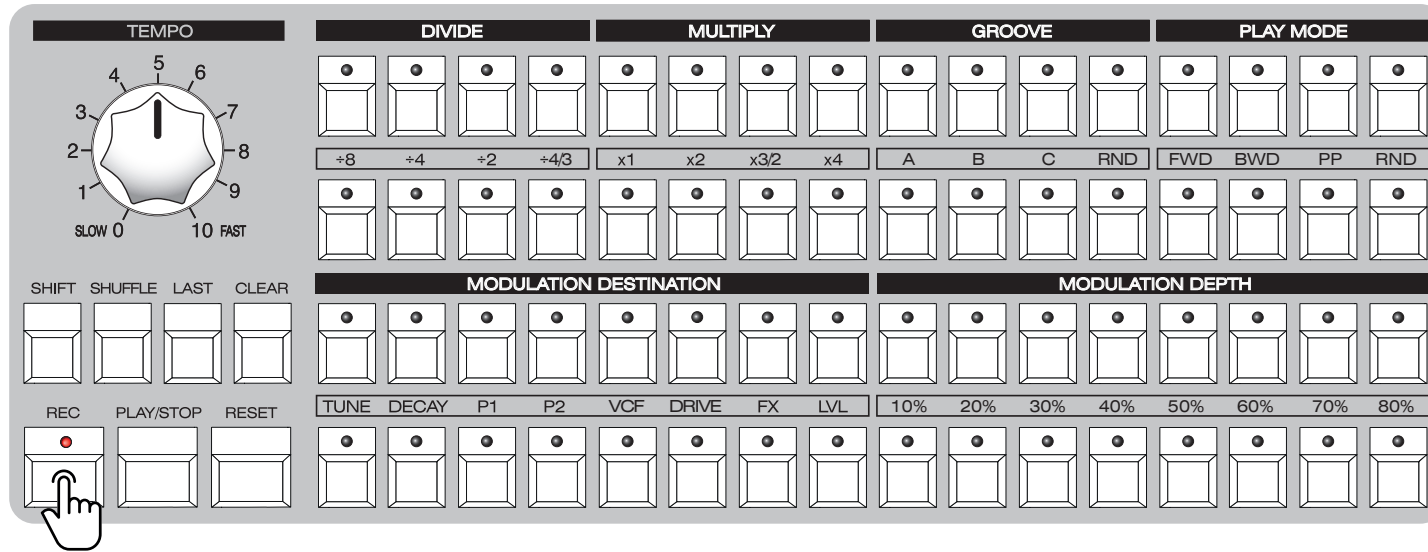

LIVE DRUM RECORDING

You can use the PĒRKONS HD-01 as a drum synthesizer module with a electronic drum pads (not included with PĒRKONS HD-01) - connect the drum pads to the trigger inputs and adjust trigger sensitivity (please, refer to Configuration Settings on page 30 of this manual). Please note the trigger inputs are not velocity sensitive.

Rhythm can be recorded via the TRIGGER IN for each voice. The steps will also be quantized, but they will also record the velocity amount if entered via external devices such as velocity-sensitive drum pads. Please note that everything is quantized to a 16-step grid at the set tempo, meaning that finer nuances (such as drum rolls/fills) will not record organically.

⚡ THE STEP SEQUENCER SECTION

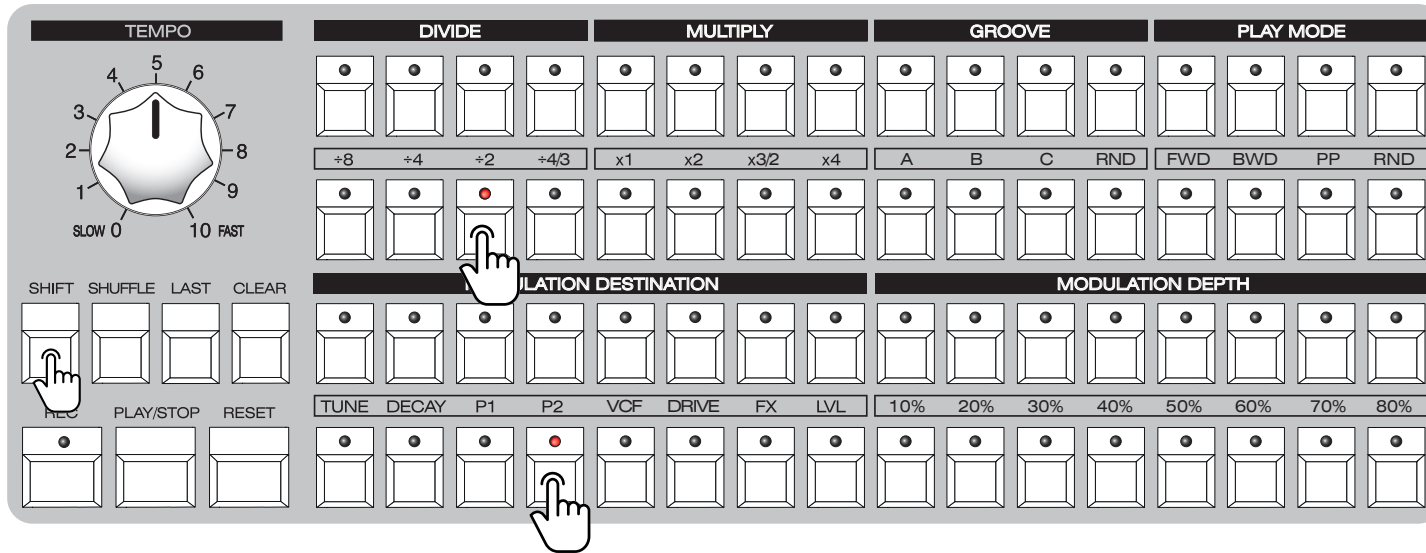

TIME DIVISIONS

The SHIFT button opens access to the secondary functions of the step sequencer buttons. Like trigger entering, it works for all four voices simultaneously. Push and hold the SHIFT button and push one of the DIVIDE buttons (first four buttons) for master clock division on the relevant voice. The LED of the relevant step button will illuminate. An example to the left shows voices 1 and 3 running at the master BPM, while voice 2 runs at the master BPM divided by 2 and voice 4 is playing triplets – divided by 4/3.

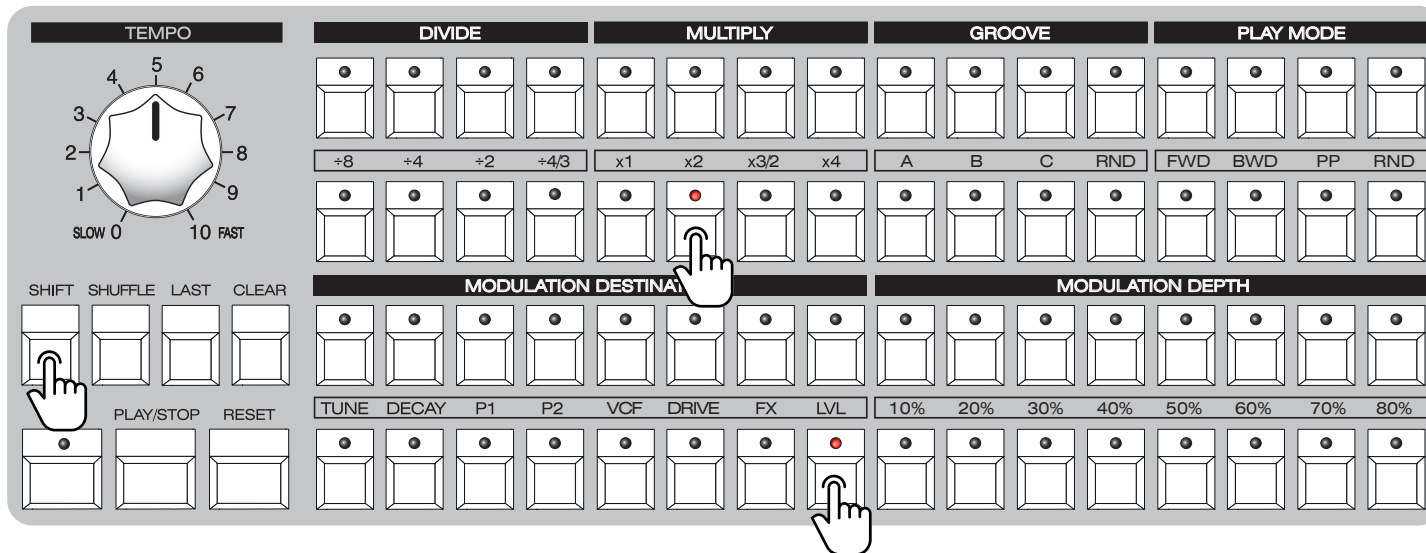

TIME MULTIPLICATIONS

Push and hold the SHIFT button and push one of the MULTIPLY buttons (buttons 5-8) for master clock multiplication on the relevant voice. The LED of the relevant step button will illuminate. An example to the left shows voices 1 and 3 running at the master BPM, while voice 2 is running at the master BPM multiplied by 2 and voice 4 – by 4.

⚡ THE STEP SEQUENCER SELCTION

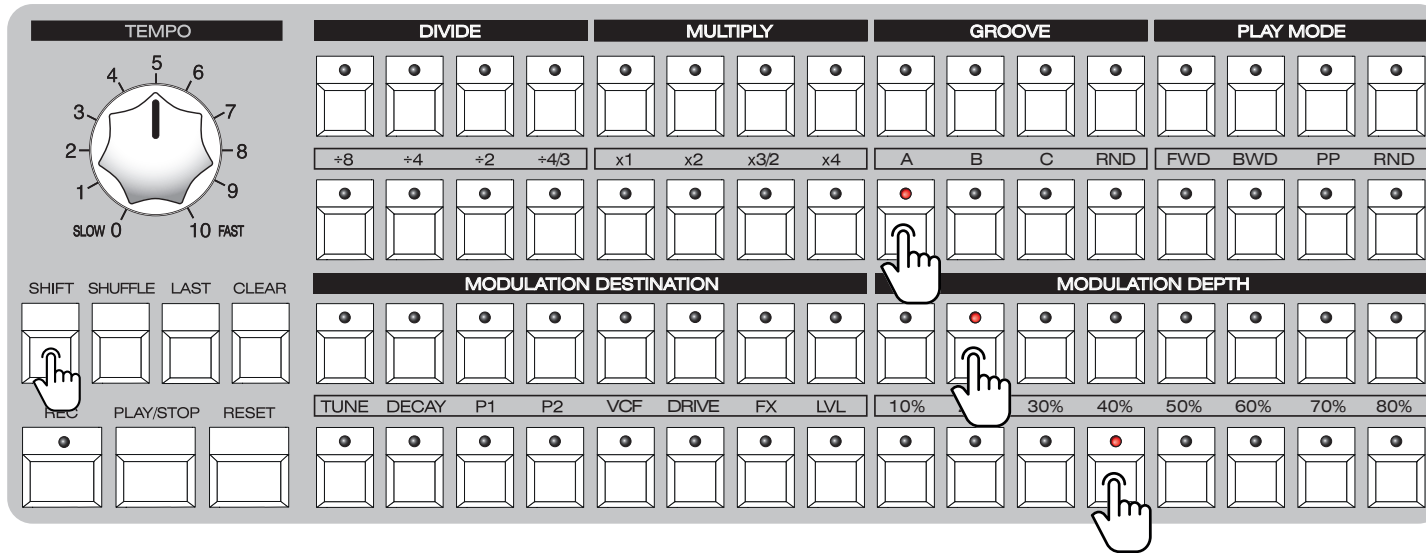

GROOVE SETTINGS

In order to "humanize" patterns, the PĒRKONS HD-01 has a special feature - GROOVE - implemented. It's basically a slight variation of drum volume on specific triggers. One of four GROOVE algorithms can be selected for each voice. In order to select the GROOVE algorithm, push and hold the SHIFT button and push one of the four GROOVE buttons. An example to the left shows GROOVE algorithm A on the second voice, algorithm B on the third voice and algorithm RND on the fourth voice.

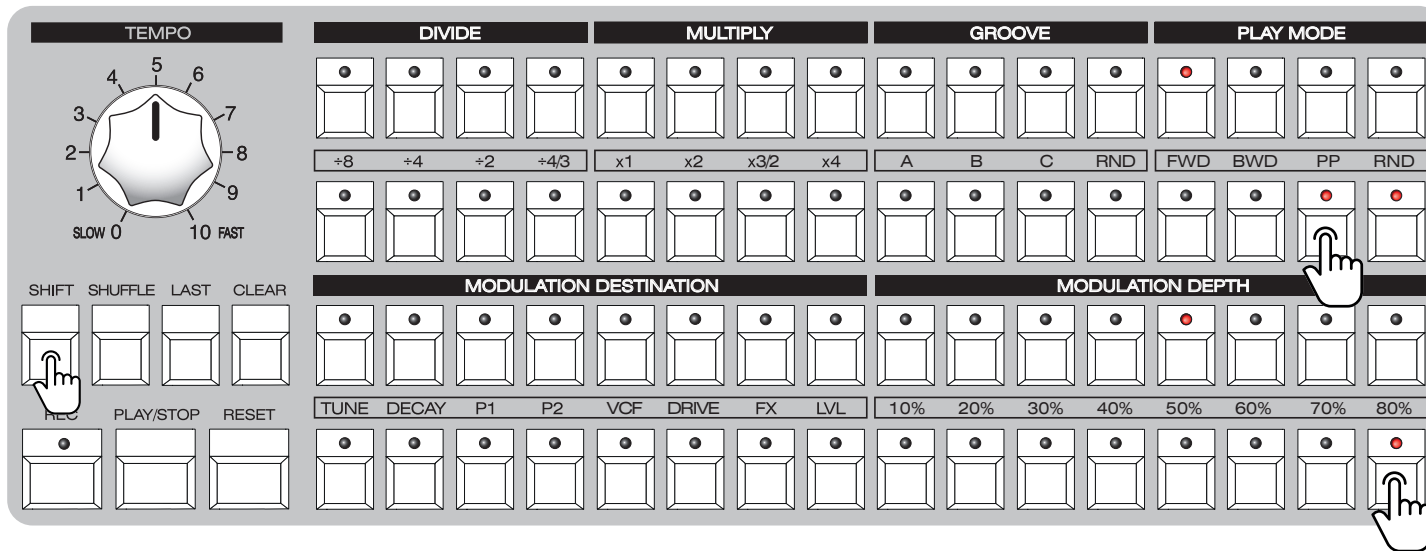

PLAY MODE SETTINGS

Each track/voice on the PĒRKONS HD-01 can be in one of four PLAY MODES - Forward, Backward, Ping-Pong and Random. In order to select the PLAY MODE, push and hold the SHIFT button and push one of the four PLAY MODE buttons. An example to the left shows the Forward mode (default one) on voices 1 and 3, Ping-Pong mode on the second voice and Random mode on the fourth voice.

⚡ PER STEP PLAY SETTINGS, AUTOMATIONS AND PARAMETER LOCKS

To “animate” your performance and give it a more “human” feel, per-step automations are available.

PER-STEP RATCHETS

You can program PER STEP RATCHETS (trigger repeats on the specific steps) on the PĒRKONS HD-01. To do so, push and hold the relevant step button while pushing and holding the RATCHET button and then pushing one of TAP buttons. There are x2, x3, x4 and x5 repeats available. An example to the left shows 4 repeats programmed on step 5 of the second voice. Push and hold a step button and press the RATCHET, ODDS1, ODDS2 and PROBABILITY buttons to inspect which of these per-step settings have been applied to the step.

PER STEP ODDS

You can program the ODDS of playing a step on the PĒRKONS HD-01, meaning, that with odds 1/2, the relevant step will be played every second time the sequencer is activating the step. To do so, push and hold the relevant step button while pushing and holding the ODDS1 (1/2, 1/3, 1/4 and 1/8) or ODDS2 (2/3, 3/4, 4/5, 7/8) button and then pushing one of TAP buttons.

An example to the left shows ODDS of 3/4, programmed on step 9 of the third voice. Push and hold a step button and press the RATCHET, ODDS1, ODDS2 and PROBABILITY buttons to inspect which of these per-step settings have been applied to the step.

Take note that only one ODDS or PROBABILITY setting can be set per-step at a time!

⚡ PER-STEP PLAY SETTINGS AND PARAMETER LOCKS

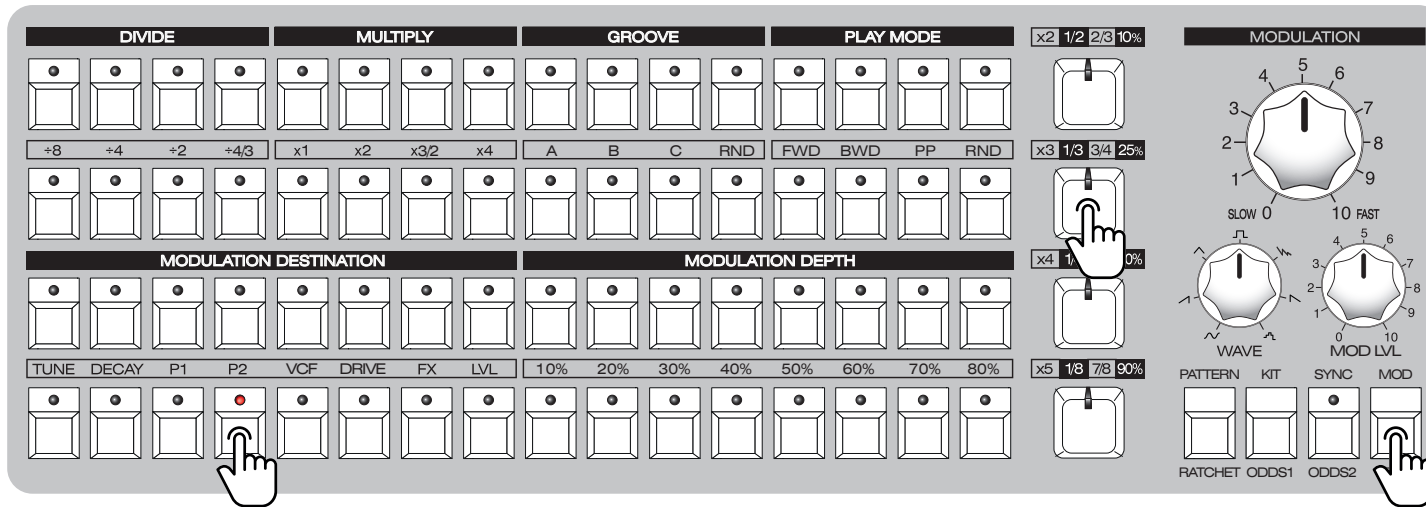

PER-STEP PROBABILITIES

You can program the statistical PROBABILITY of playing a step on the PĒRKONS HD-01, meaning that a step will be played at, for example, a 25% probability when the sequencer is activating the step. To do so, push and hold the relevant step button while pushing and holding the PROB button and then push one of the TAP buttons. 10%, 25%, 50% and 90% probabilities of playing a step are available. An example to the left shows a PROBABILITY of 25% programmed on step 4 of the fourth voice.

Push and hold a step button and press the RATCHET, ODDS1, ODDS2 and PROBABILITY buttons to inspect which of these per-step settings have been applied to the step.

PER STEP PARAMETER LOCKS

You may want to design a Hi-Hats track with closed and open hats, and specific steps need a longer decay. On the PĒRKONS HD-01 you can per step record any voice parameter changes as a parameter lock. To do so, push and hold the step button and alter any control (a knob or a switch) in the relevant voice section. Once the button is released the position of the control is automatically saved.

An example to the left shows opening of the filter on the fifth step on the first voice. Please note, parameter locks do not apply to the master section.

You can also do parameter automations for all voices simultaneously. To do so, push and hold the SHIFT button and rotate, for example, any TUNE knob. The tune will be altered for all four voice simultaneously.

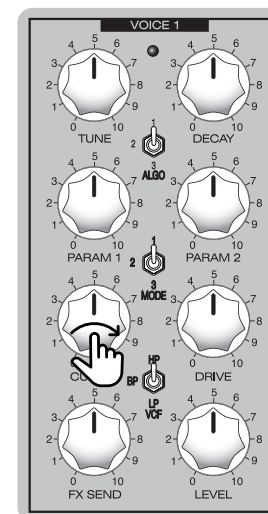
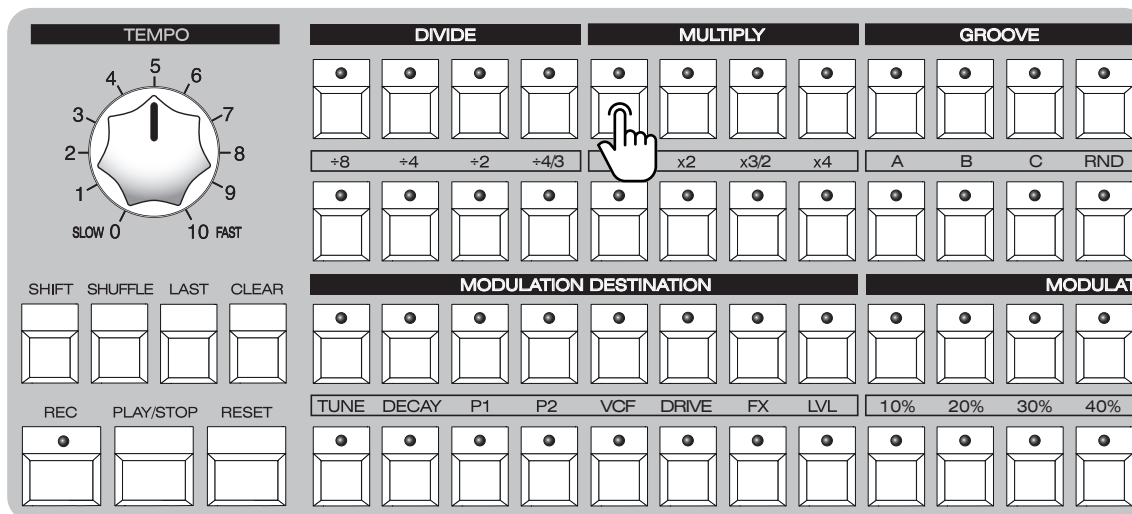

STEP COPY/PASTE

This feature can come in handy if you want to copy a step with specific parameter locks and paste it elsewhere in the sequence. To do this, push and hold the step you want to copy and press REC once. The step has been copied! To paste it, activate a new step and hold it or push and hold an existing step and press SHIFT once - the parameter locks of the copied step have been pasted! Please note that you can only copy and paste steps within the sequence of a single voice - you cannot copy/paste between the voices.

⚡ PATTERN AND KIT SAVING AND RECALLING

Both patterns and kits can be saved and recalled. A kit entails the voice parameter settings for all four voices, while a pattern entails the sequencer settings (last step, division/multiplication, ratchets, probabilities, steps, play direction, shuffle amount, groove settings) for all four voices.

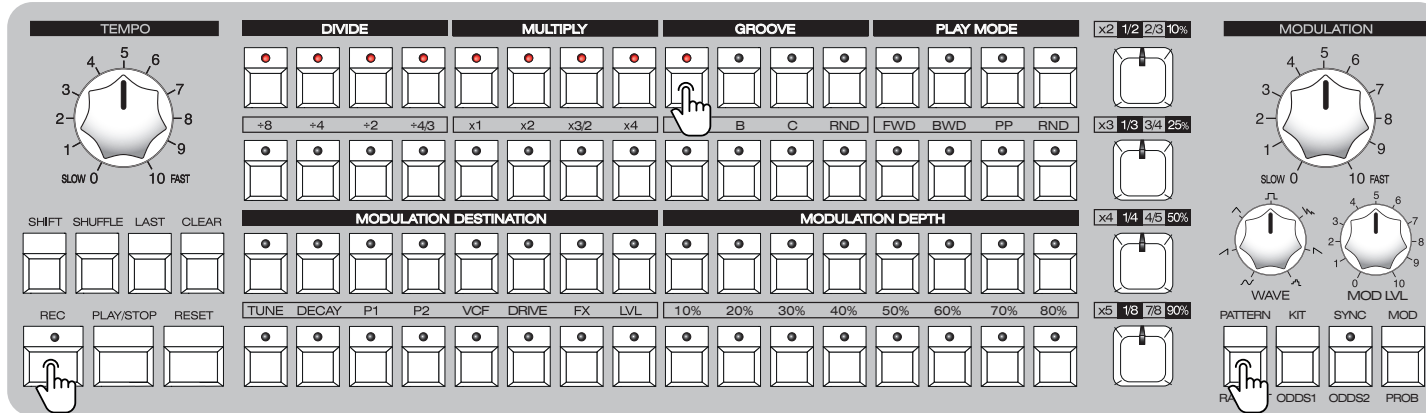

PATTERN SAVING

To save a pattern, press the PATTERN button – you have now entered the pattern menu. Here, each step button represents a pattern. The brightest illuminated step button is the currently selected pattern, while the less illuminated steps represent slots with patterns saved in them. To save a pattern, push and hold the REC button and press one of the step buttons representing a pattern slot, you wish to save. The LED will flash on the REC button, indicating a successful save. You can save up to 64 patterns in the step sequencer slots. You can save the same pattern to multiple slots by holding down the REC button and pressing on multiple step buttons – the REC button will flash upon each successful save.

If you want to quickly save changes made to the currently playing pattern, press and hold the PATTERN button and press the REC button promptly.

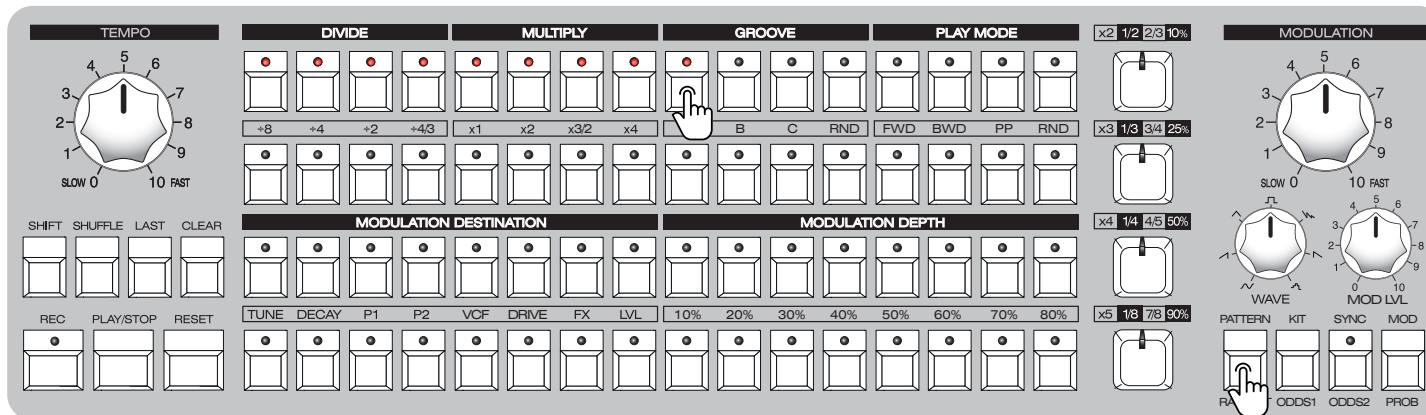

PATTERN LOADING

To LOAD the patterns, initiate the PATTERN menu, press the step button for pattern you wish to recall – the pattern will be loaded after the last step of the previous pattern has finished playing and the sequencer will advance to the pattern design mode. To instantly switch to the desired pattern, press and hold the SHIFT button while in the PATTERN menu and press the desired pattern button!

⚡ PATTERN AND KIT SAVING AND RECALLING

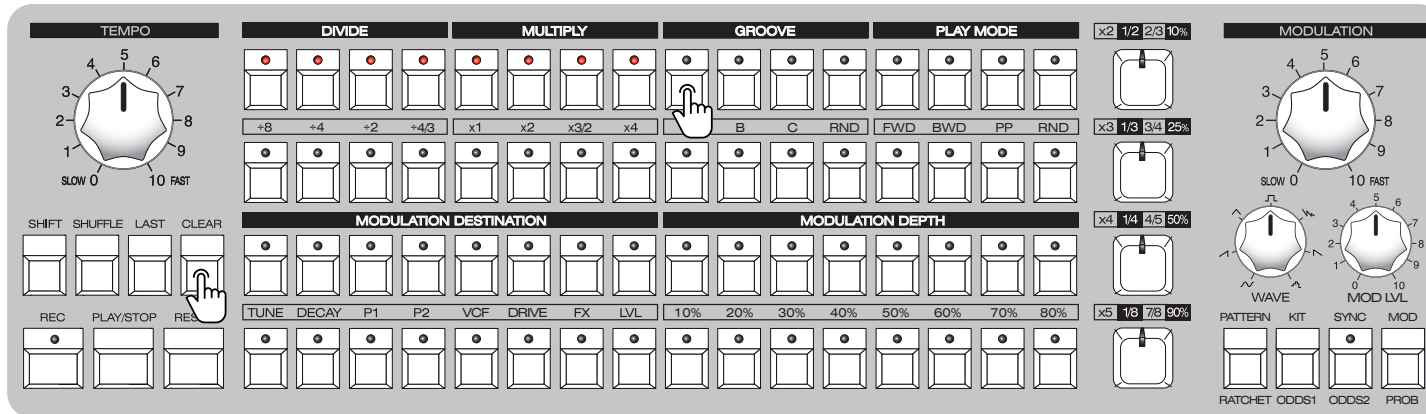

PATTERN CLEARING

To clear the patterns, initiate the PATTERN menu, press and hold the CLEAR button and press the step buttons – the LED's will turn off, indicating the slots have been cleared. To exit the pattern menu, press the PATTERN button again.

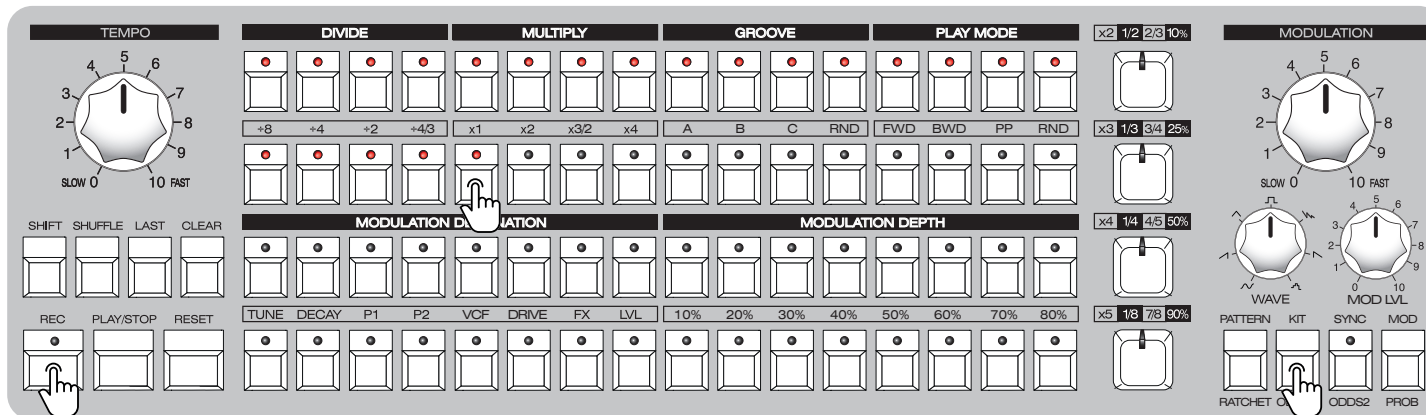

KIT SAVING

Kits are saved and cleared the same way - to save a kit, press the KIT button – you have now entered the kit menu. Here, each step button represents a kit. The brightest illuminated step button is the currently selected kit, while the less illuminated steps represent slots with kits saved in them. To save a kit, push and hold the REC button and press one of the step buttons representing a kit slot, you wish to save. The LED will flash on the REC button, indicating a successful save. You can save up to 64 kits in the step sequencer slots. You can save the same kit to multiple slots by holding down the REC button and pressing on multiple step buttons – the REC button will flash upon each successful save.

Kits and patterns are linked (you can disable pattern & kit linking in the config menu) together, so when you load a pattern, it will also load the corresponding kit. You can change to a different kit once you have loaded a pattern – if you save the pattern again with the other kit playing in the same slot, it will then play with this kit once loaded.

⚡ PATTERN AND KIT SAVING AND RECALLING

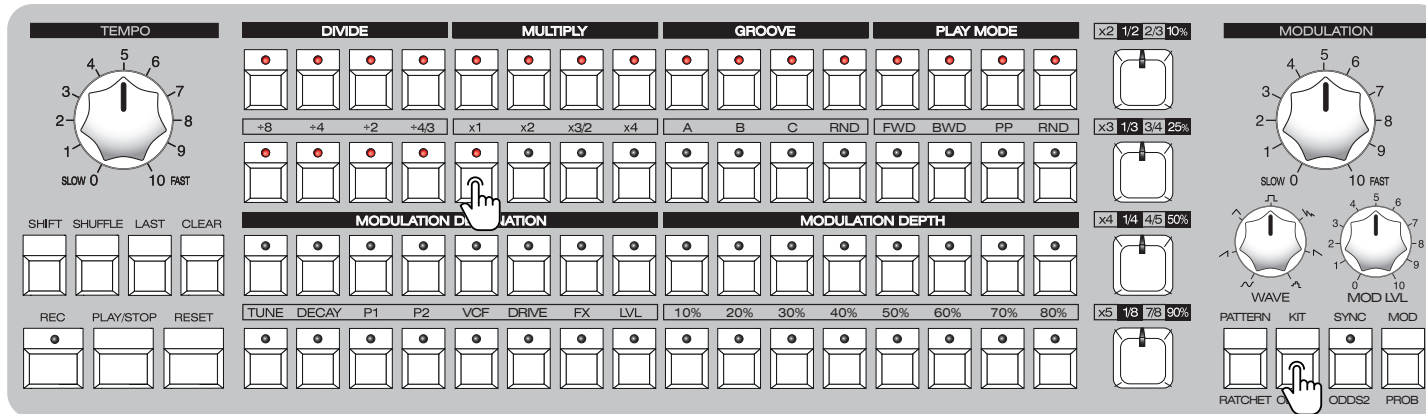

KIT LOADING

To LOAD the kit, initiate the KIT menu, press the step button for a kit you wish to recall – the kit will be instantly loaded and the sequencer will advance to the pattern design mode.

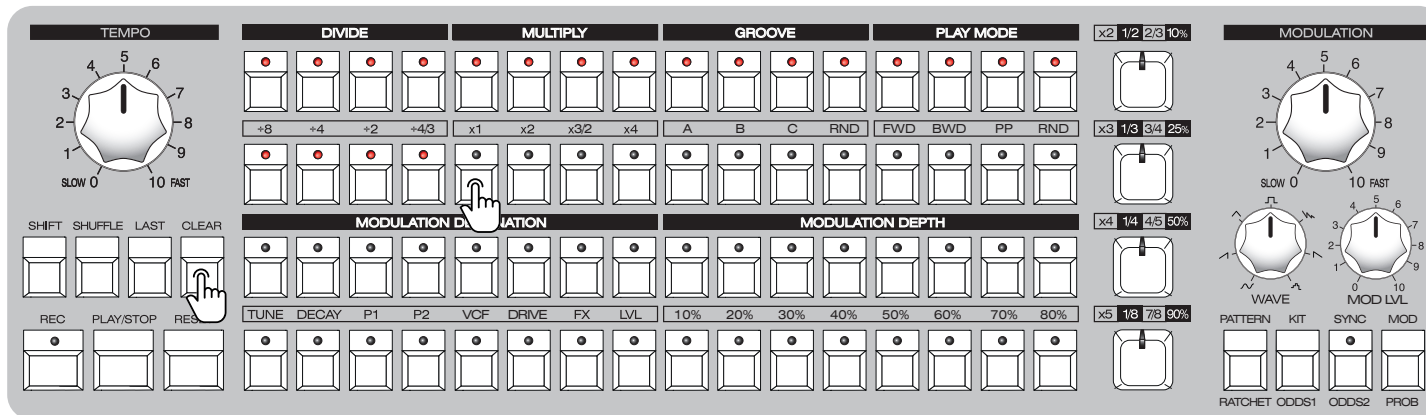

KIT CLEARING

To clear kits, press and hold the CLEAR button and press on the step buttons – the LED's will turn off, indicating the slots have been cleared. To exit the kit menu, press the KIT button again.

MANUAL OVERRIDE

While performing, you may want to exit from any selected kit and to play with the parameters as they are configured via the knobs - to do this, hold CLEAR and press KIT - the PERKONS will instantly remove any kit parameter locks and you will gain full manual control over all voice parameters.

⚡ PATTERN CHAINING

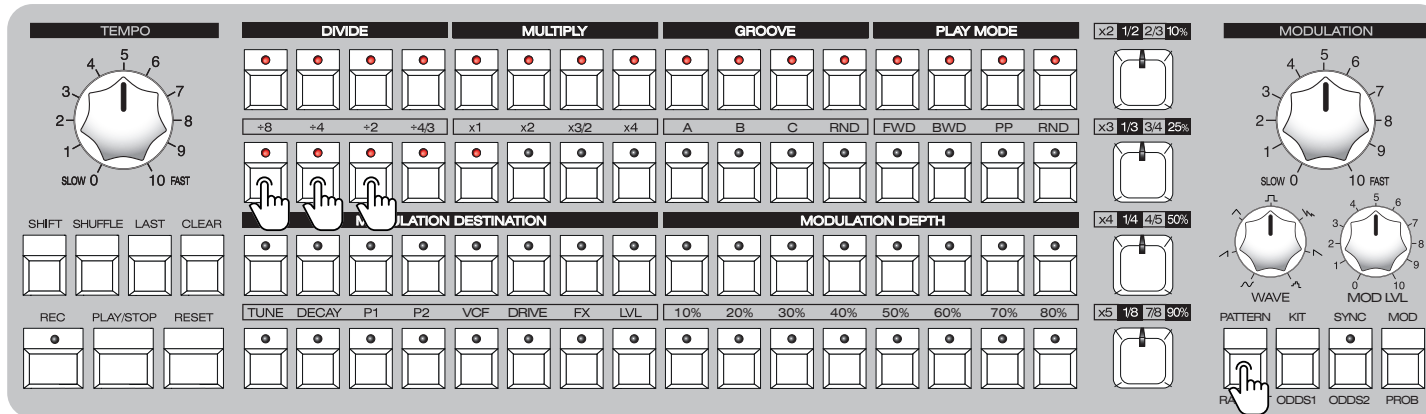

In order to make longer than 16 step patterns, you can chain several patterns sequentially. To do so, initiate the pattern menu by pressing PATTERN button, and press several consecutive step buttons that represent saved patterns. All selected patterns will be played back in consecutive order.

Please note that, in order to play back patterns correctly, you need to set a MASTER PATTERN LENGTH (refer to page 15 of this manual). An example to the left shows patterns 17 – 19 chained in one longer pattern.

⚡ BANKS

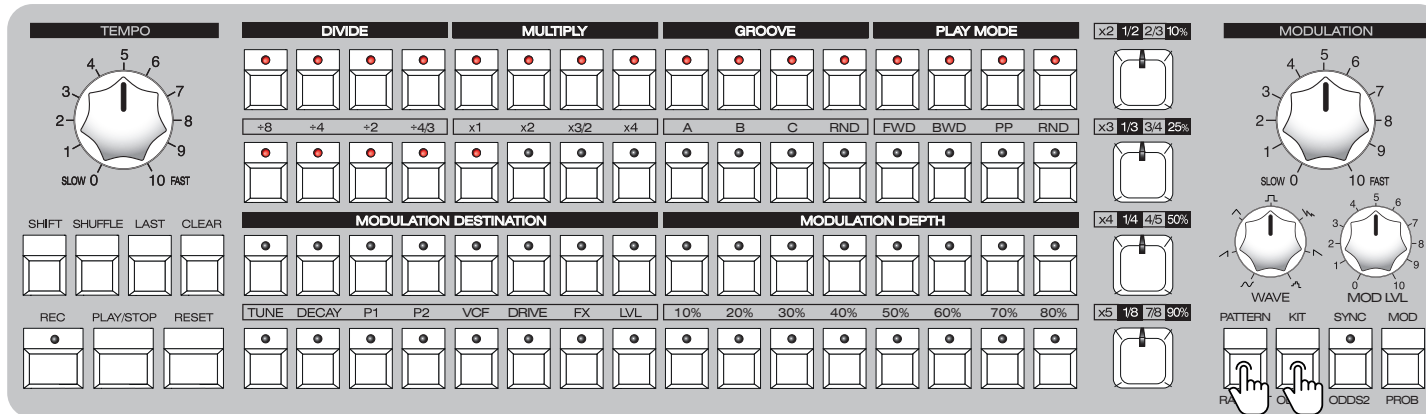

To add even more workflow options, the PĒrkons has 64 banks, each bank containing 64 kits and 64 patterns. To access the bank menu, press and hold PATTERN and press KIT – both LED's will illuminate.

Here, you can switch between the banks – each bank is indicated by a sequencer step, with the 1st step of the 1st row indicating the 1st bank and the last step of the last row indicating the 64th bank. The brightest visible LED indicates the selected bank.

Once you have selected a bank, press PATTERN or KIT – here you can access all of the patterns or kits (respectively) that have been saved within this bank. When power cycling, the PĒRKONS will automatically load the last selected bank and last selected kit/pattern within that bank. When selecting a different bank, the PĒRKONS will automatically load the last selected kit/pattern in that bank.

Please note, that when switching between banks while the sequencer is running, there will be a short pause until the next selected bank is loaded – for this reason, we don't recommend switching between banks while performing – instead you should switch between patterns and kits saved in a single, loaded bank.

⚡ MODULATION SETTINGS

The PĒRKONS has a built-in modulator – an LFO with a selectable waveform – there are seven waveforms to choose from and these are indicated with symbols printed around the WAVE knob.

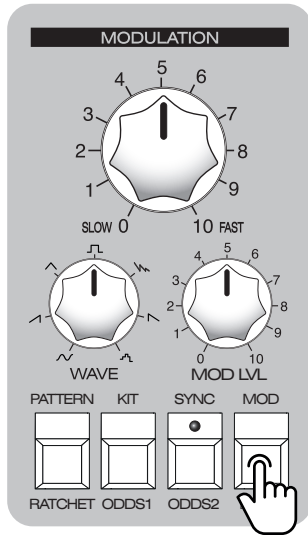

WAVE	
	SINE
	RAMP
	TRIANGLE
	PULSE
	DOUBLE DECAY SAW
	SAW
	RANDOM

The large knob indicates the rate of the LFO, while the MOD LVL knob indicates the master modulation amount the LFO exerts on the functions it is assigned to. The LFO can be assigned to all of the voice parameters. In order to do this, press the MOD button – you have now entered the MOD menu for LFO assignment.

Above the bottom sequencer row, you can see the modulation destinations on the left side (step buttons 1-8) and the modulation depth percentages on the right side (step buttons 9-16).

Once in the MOD menu, each sequencer row represents a voice – the brightest illuminated step LED in each row indicates the currently selected assignment destination, while less-illuminated steps indicate other destinations within the same voice the LFO has been assigned to.

Select a destination by pressing step keys 1-8, and by pressing step keys 9-16 enter the modulation depth – the maximum is 80% and to turn off the depth (thus unassigning the LFO from the destination), press the step button representing 10% and press it again – the LED will turn off. You can also clear all modulation destinations per-voice by pressing and holding CLEAR while pressing the respective voice tap key.

To exit the MOD menu, press the MOD button again. An example to the left shows a modulation assigned to the tune of the first voice at 50% depth. The modulation settings are saved within the KIT!

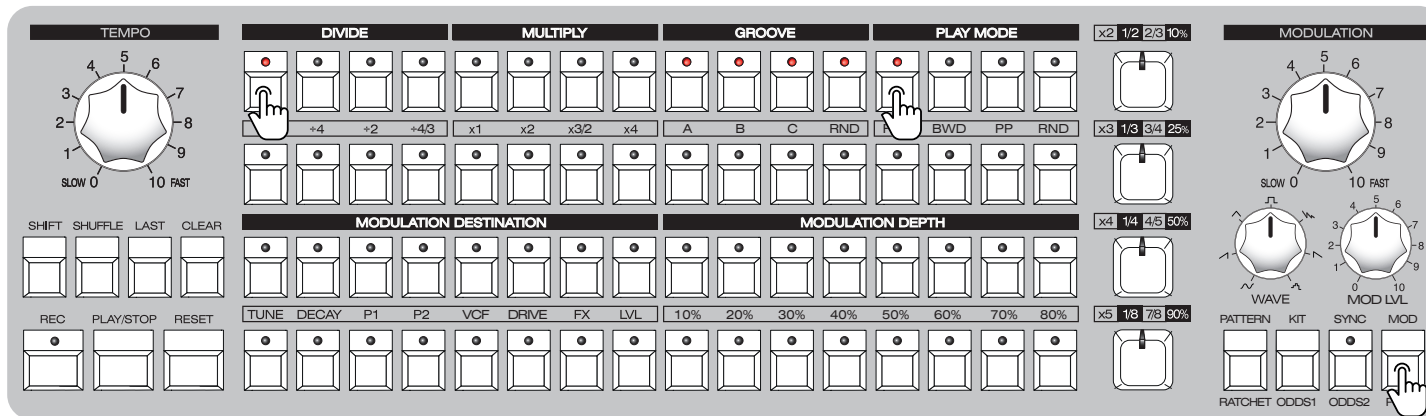

⚡ MODULATION SETTINGS

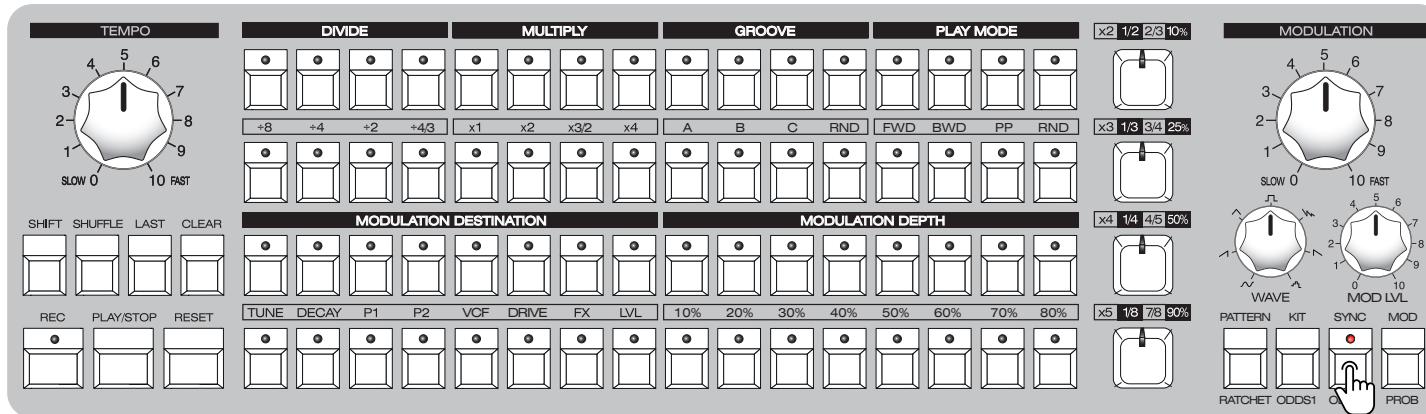

The LFO can either oscillate freely or can run synchronized to the clock – this is done via the SYNC button – the LED on indicates it synchronized. The minimum rate of the freely-oscillating LFO is 0.1Hz, while the maximum rate is 20Hz. When synced, the large knob acts as a clock multiplier/divider – at the 12o'clock position it is 1, turning it clockwise creates multiplications of x2, x4 and x8, while turning it counter-clockwise creates divisions of ÷2, ÷4 and ÷8. Please note that the multiplications/divisions do not exactly correspond to the numbers around the knob.

⚡ FIRMWARE UPDATE

In order to update the firmware of the PĒRKONS HD-01, remove the SD card from the synth and power it off. Connect the SD card to your computer and place the firmware update file onto the root directory of the card. Eject the card from your computer and place it back into the PĒRKONS. Mind the orientation - the golden pin strips should face upwards (you can see a printed icon indicating this on the panel of the synth). Hold all four voice trigger keys simultaneously while powering on the PĒRKONS - you will see the first row of sequencer steps light up - you can release the keys once the steps begin illuminating. Once the entire first row has lit up, the third row will light up, followed by the second and fourth rows. Once the final row has lit up, the PĒRKONS will boot normally - the firmware update has been installed successfully!

⚡ CONFIGURATION SETTINGS

the “bar-graph” reaches on the hardest hits and push step button 16 of the relevant track to increase the sensitivity or step button 1 to decrease it. Optimum sensitivity has been achieved once the “bar-graph” reaches step 12 at the hardest hit. Complete the calibration for all four tracks.

MM In **MULTI MIDI CHANNEL** mode, you can assign different MIDI channels to each track. Simply use the step buttons of each track to select a MIDI channel.

MC In the **SINGLE CHANNEL MIDI CONFIG** menu, you can select a MIDI channel for controlling the PĒRKONS.

1 **Step button 1 of the second track turns kit linking to the pattern ON or OFF**. With KIT LINK ON, an active kit is saved together with the pattern. You can select a different kit after the pattern is loaded. With KIT LINK OFF, only the step sequencer pattern is saved.

2 Step button 2 of the second track turns the potentiometer position memory **ON or OFF when you change kits**. Each drum kit has specific voice potentiometer and switch positions and when you change the kit, in most cases, these positions will be different. In the POT CATCH ON setting, you need to rotate the relevant potentiometer through the previously saved position before it starts altering the parameter, thus providing a continuous change in sound. With POT CATCH set to OFF, the potentiometer, once rotated, will have an immediate

effect on the sound. This provides more hands-on control over the voice parameters, but it may alter the sound radically.

3 **Step button 3 of the second track turns the accents ON or OFF**. With ACCENT ON, you can accent steps by double pressing the relevant step button. The LED on an accented step button will be lit brighter than those on un-accented steps.

4 **Step button 4 of the second track toggles between SMOOTH or DISCRETE PARAMETER RECORDING**. In discrete mode (LED off) parameter value changes (rotation of any of the voice potentiometers) are quantized to steps. In smooth mode (LED on) a “glide” between steps is applied and as result, the recorded changes of parameter movements are smoother.

5 **Step button 5 of the second track turns on the VINTAGE BBD mode** – it’s bit noisier and sounds more like vintage analogue BBD effects.

6 **Step button 6 of the second track turns trigger mute mode ON or OFF**. This mode can come in handy when performing live - with the trig mute mode ON, the cherry keys immediately mute/unmute the voices when pressed instead of requiring holding SHIFT to do this for easier, one-handed operation. The voices can still be previewed via the cherry keys when the sequencer is stopped.

7 **Step button 7 of the second track toggles the filter switch slew mode ON or OFF** - by default this is OFF (enabled) and this way when switching between filter modes, there is less of an audible click noise, whereas with this mode set to ON (disabled), there is no gradual changeover and the clicking is much more audible.

1-7 **Step buttons 1-7 of the third track turn MIDI functions ON or OFF**. Step button 1 selects SINGLE MIDI CHANNEL mode, step button 2 selects MULTI MIDI CHANNEL mode, step button 3 activates MIDI CLOCK on MIDI OUT, step button 4 turns MIDI clock ON or OFF when the sequencer is stopped, step button 5 activates MIDI THRU. With step button 6 ON, the PĒRKONS sends out all MIDI information from the internal sequencer. Step button 7 turns on the transmission of parameter MIDI CC messages via the MIDI OUT port.

FR For a factory reset, simultaneously push step buttons 15 and 16 of the fourth track.

⚡ MIDI IMPLEMENTATION

	VOICE 1	VOICE 2	VOICE 3	VOICE 4
TUNE	70	81	92	103
DECAY	71	82	93	104
PARAM1	72	83	94	105
PARAM2	73	84	95	106
CUTOFF	74	85	96	107
DRIVE	75	86	97	108
FX SEND	76	87	98	109
LEVEL	77	88	99	110
ALGO SWITCH	78	89	100	111
MODE SWITCH	79	90	101	112
FILTER SWITCH	80	91	102	113

All 8 potentiometers and 3 switches of each voice on the PĒRKONS can be controlled via MIDI CC messages. In SINGLE MIDI CHANNEL mode, the MIDI implementation is as shown in the table below. Voices will be triggered by NOTE ON messages – Voice 1 – C, Voice 2 – C#, Voice 3 – D, Voice 4 – D#.

In MULTI MIDI CHANNEL mode, MIDI CC messages for all voices are the same as for VOICE 1, but you have to assign voices to different MIDI channels.

⚡ MIDI IMPLEMENTATION

SYSTEM FOLDER

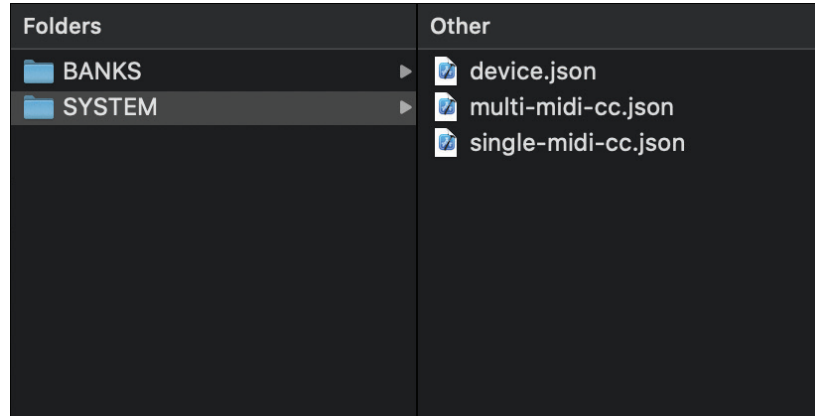

SINGLE-MIDI-CC.JSON FILE

```
single-midi-cc - Note...
File Edit View
{
  "voice1": {
    "tune": 70,
    "decay": 74,
    "param1": 71,
    "param2": 75,
    "cutoff": 72,
    "drive": 76,
    "fx-send": 73,
    "level": 77,
    "algo": 78,
    "mode": 79,
    "filter": 80
  },
  "voice2": {
    "tune": 81,
    "decay": 85,
    "param1": 82,
    "param2": 86,
    "cutoff": 83,
    "drive": 87,
    "fx-send": 84,
    "level": 88,
    "algo": 89,
    "mode": 90,
    "filter": 91
  },
  "voice3": {
    "tune": 92,
```

You can alter the MIDI CC message assignment to your preference simply by replacing CC message numbers in a text file on the SD card. To do so, insert the SD card into your PC and open the SYSTEM folder. Then open the single-midi-cc.json file in a text editor and set MIDI CC numbers for each control. Once done, save the changes made to the file on the SD card and insert it back into the PÈRKONS. The synthesizer will automatically reconfigure CC messages to your preferred settings.

⚡ SAFETY INSTRUCTIONS

Please follow the instructions for the use of the Erica Synths PĒRKONS below, because only this will guarantee the proper operation of the module and ensure the warranty from Erica Synths.



Use the PĒRKONS exclusively with the power supply unit (PSU) supplied with the system. Powering it with other PSU units may cause permanent damage to the device.



Water is lethal for most electric devices unless they have been rendered waterproof. The PĒRKONS is NOT intended for use in a humid or wet environment. No liquids or other conducting substances should be allowed into the module. Should this happen, the module should be disconnected from mains power immediately, dried, examined and cleaned by a qualified technician.



Do not expose the instrument to temperatures above +50° C or below -20° C. If you have transported the instrument in extremely low temperatures, leave it at room temperature for an hour before plugging it in.



Transport the instrument carefully. Never let it drop or fall over. The Warranty does not apply to instruments with visual damage.



PĒRKONS must be shipped in the original packaging only. Any instrument shipped to us for return, exchange and/or warranty repair must be in its original packaging. All other deliveries will be rejected and returned to you. Ensure that you keep the original packaging and technical documentation.

DISPOSAL

This device complies with EU guidelines and is manufactured and confront RoHS without the use of lead, mercury, cadmium or chrome. Nevertheless, this device is special waste and disposal in household waste is not recommended.

User manual by Girts Ozolins@Erica Synths.

Design by Ineta Briede@Black8 & Maija Vītola@Black8.

Copying, distribution or any commercial use in any way is prohibited and needs the written permission of Erica Synths.

The specifications are subject to change without notice.

If you have any questions, feel free to contact us on SUPPORT section on www.ericasynths.lv

WARRANTY

You will find the Erica Synths terms of warranty at www.ericasynths.lv

Items for return, exchange and/or warranty repair should be sent us according to the guidelines on SUPPORT section on www.ericasynths.lv