

# Quick Start Guide

## MULTIMODE FILTER / RESONATOR MODULE 1047

Legendary 2500 Series 12dB State Variable Filter Module for Eurorack

### Controls

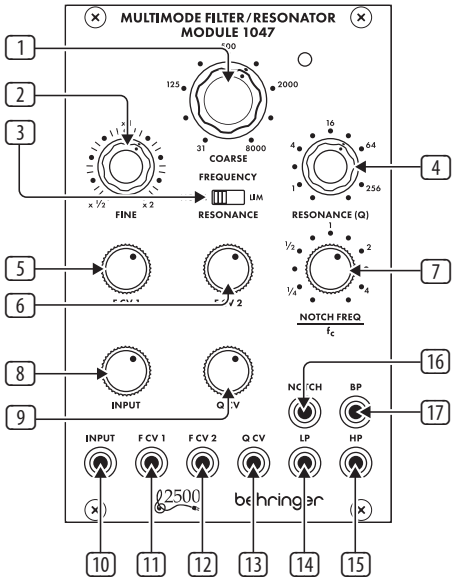

- 1 **COARSE** – Use this knob to dial in the general frequency area you want for the high-pass threshold, low-pass threshold, band-pass center frequency and notch filter center frequency, then go to the FINE knob to refine the frequency setting. The frequency set by the COARSE and FINE knobs (“fc”) will be used simultaneously for every filter in the module.
- 2 **FINE** – Use this knob to refine and focus the frequency set by the COARSE FREQUENCY knob.
- 3 **RESONANCE (NORM/LIM)** – This sliding switch lets you choose between normal resonance mode (NORM) and limiting mode (LIM), which limits the height of a filter’s resonant peak. The LIM setting prevents circuit overload when focusing a filter on a strong harmonic or fundamental frequency, especially at high Q settings on

the RESONANCE (Q) knob. In other situations, the LIM setting can result in a very low output signal, and so the NORM setting is usually preferred.

- 4 **RESONANCE (Q)** – This knob controls the width/smoothness and narrowness/sharpness of the filter curves. At low Q settings, the filter curves are wider and smoother, with a gentler effect on the sound (except for the notch filter, which functions most effectively at low Q settings). As you increase the Q setting, the filter curves gradually become narrower and sharper, which can help you to focus in on narrow frequency bands. At higher Q settings, the various filters can produce resonant peaks in the filter curves that boost some frequencies and may require moving the RESONANCE (NORM/LIM) switch to the LIM setting to prevent overloading the circuit (or the INPUT attenuator knob can be turned down).
- 5 **F CV 1** – This knob adjusts the strength of the control voltage signal coming in through the F CV 1 jack.
- 6 **F CV 2** – This knob adjusts the strength of the control voltage signal coming in through the F CV 2 jack.
- 7 **NOTCH FREQUENCY/fc** – Use this knob to offset the notch filter’s center frequency (“fc”) set by the COARSE and FINE frequency controls. For standard notch filter behavior, the NOTCH FREQ/fc control should be set to “1” on the scale. This standard setting can then be tweaked by moving the NOTCH FREQ/fc knob very slightly around “1”. Also, if higher Q values are added via the RESONANCE knob while the notch filter is offset from fc, the higher Q values result in a resonant peak at fc, with the notch at the point set by the NOTCH FREQ/fc knob.

Knob Setting	Effect
Full CCW	Notch filter output becomes a copy of the high-pass output
CCW to 1/4	Notch frequency shifts significantly below fc
CW to 4	Notch frequency shifts significantly above fc
Full CW	Notch filter output becomes a copy of the low-pass filter output

- 8 **INPUT** – This knob adjusts the strength of the audio signal coming through the INPUT jack.
- 9 **Q CV** – This knob adjusts the strength of the Q control voltage signal coming in through the Q CV jack.
- 10 **INPUT** – Use this jack to route audio signals into the module via cables with 3.5 mm connectors. You can also route in a keyboard gate signal to “ring” the filter and produce a unique percussive sound when you press a key.



- 11 **FCV 1** – Use this jack to route external control voltage or modulation signals for the filter frequency setting into the module via cables with 3.5 mm connectors.
- 12 **FCV 2** – Use this jack to route external control voltage or modulation signals for the filter frequency setting into the module via cables with 3.5 mm connectors.
- 13 **QCV** – Use this jack to route external control voltage signals for the RESONANCE (Q) setting into the module via cables with 3.5 mm connectors.
- 14 **LP** – This jack sends out the final signal from the low-pass filter via cables with 3.5 mm connectors.
- 15 **HP** – This jack sends out the final signal from the high-pass filter via cables with 3.5 mm connectors.
- 16 **NOTCH** – This jack sends out the final signal from the notch filter via cables with 3.5 mm connectors.
- 17 **BP** – This jack sends out the final signal from the band-pass filter via cables with 3.5 mm connectors.

### Power Connection

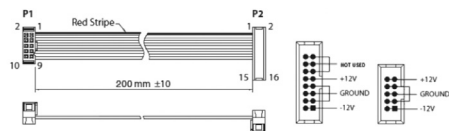

Connect end P1 to the module socket  
Connect end P2 to the power supply

The MULTIMODE FILTER / RESONATOR MODULE 1047 module comes with the required power cable for connecting to a standard Eurorack power supply system. Follow these steps to connect power to the module. It is easier to make these connections before the module has been mounted into a rack case.

1. Turn the power supply or rack case power off and disconnect the power cable.
2. Insert the 16-pin connector on the power cable into the socket on the power supply or rack case. The connector has a tab that will align with the gap in the socket, so it cannot be inserted incorrectly. If the power supply does not have a keyed socket, be sure to orient pin 1 (-12 V) with the red stripe on the cable.
3. Insert the 10-pin connector into the socket on the back of the module. The connector has a tab that will align with the socket for correct orientation.
4. After both ends of the power cable have been securely attached, you may mount the module in a case and turn on the power supply.

### Installation

The necessary screws are included with the module for mounting in a Eurorack case. Connect the power cable before mounting.

Depending on the rack case, there may be a series of fixed holes spaced 2 HP apart along the length of the case, or a track that allows individual threaded plates to slide along the length of the case.

The free-moving threaded plates allow precise positioning of the module, but each plate should be positioned in the approximate relation to the mounting holes in your module before attaching the screws.

Hold the module against the Eurorack rails so that each of the mounting holes are aligned with a threaded rail or threaded plate. Attach the screws part way to start, which will allow small adjustments to the positioning while you get them all aligned. After the final position has been established, tighten the screws down.

### Filter Curves

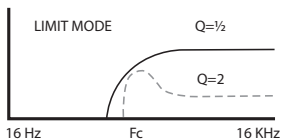
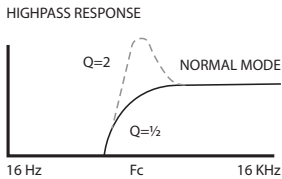
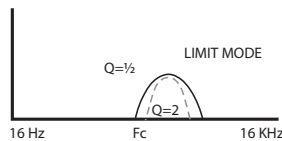
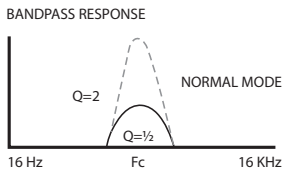
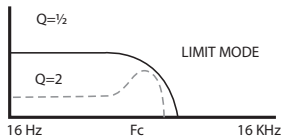
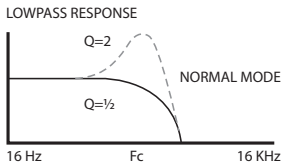

## Notch Responses

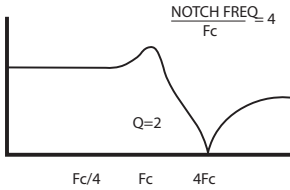
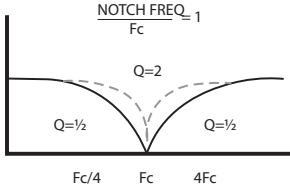
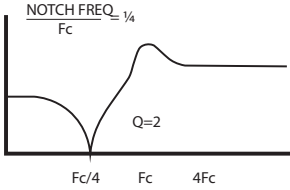

## Specifications

### Inputs

Input	
Type	1 x 3.5 mm TS jack, DC coupled
Impedance	50 k $\Omega$ , unbalanced
Max input level	+18 dBu

### Frequency CV input 1

Type	1 x 3.5 mm TS jack, DC coupled
Impedance	50 k $\Omega$ , unbalanced
Max input level	$\pm 10$ V
CV scaling	1 V/oct.

### Frequency CV input 2

Type	1 x 3.5 mm TS jack, DC coupled
Impedance	50 k $\Omega$ , unbalanced
Max input level	$\pm 10$ V
CV scaling	1 V/oct.

### Q CV input

Type	1 x 3.5 mm TS jack, DC coupled
Impedance	50 k $\Omega$ , unbalanced
Max input level	$\pm 10$ V
CV scaling	1 V doubles the Q factor

### Outputs

#### Filter outputs (LP / HP / BP / Notch)

Type	4 x 3.5 mm TS jack, DC coupled
Impedance	1 k $\Omega$ , unbalanced
Max output level	+18 dBu

### Controls

Coarse frequency	1 x rotary knob, 31 Hz to 8 kHz
Fine frequency	1 x rotary knob, x1/2 to x2
Resonance (Q)	1 rotary knob, Q = 0.5 to >256
Resonance (Norm / lim)	2-way sliding switch Normal / limiting, switchable
Frequency CV 1 / 2 attenuators	2 x rotary knob, $-\infty$ to unity gain
Q CV attenuator	1 x rotary knob, $-\infty$ to unity gain
Input attenuator	1 x rotary knob, $-\infty$ to unity gain
Notch frequency/fc	1 x rotary knob, $\pm 3$ octave range

### Power

Power supply	Eurorack
Current draw	55 mA (+12 V), 45 mA (-12 V)

### Physical

Dimensions	43 x 81 x 129 mm (1.7 x 3.2 x 5.1")
Rack units	16 HP
Weight	0.17 kg (0.37 lbs)

## LEGAL DISCLAIMER

Music Tribe accepts no liability for any loss which may be suffered by any person who relies either wholly or in part upon any description, photograph, or statement contained herein. Technical specifications, appearances and other information are subject to change without notice. All trademarks are the property of their respective owners. Midas, Klark Teknik, Lab Gruppen, Lake, Tannoy, Turbosound, TC Electronic, TC Helicon, Behringer, Bugera, Auratone and Coolaudio are trademarks or registered trademarks of Music Tribe Global Brands Ltd. © Music Tribe Global Brands Ltd. 2020 All rights reserved.

---

## LIMITED WARRANTY

For the applicable warranty terms and conditions and additional information regarding Music Tribe's Limited Warranty, please see complete details online at [musictribe.com/warranty](https://musictribe.com/warranty).