

Quadrax

(Including Optional Qx Expander)

4-Channel CV-Controllable Function Generator
With Cycling, Pulse Burst Generation and Morphing LFO

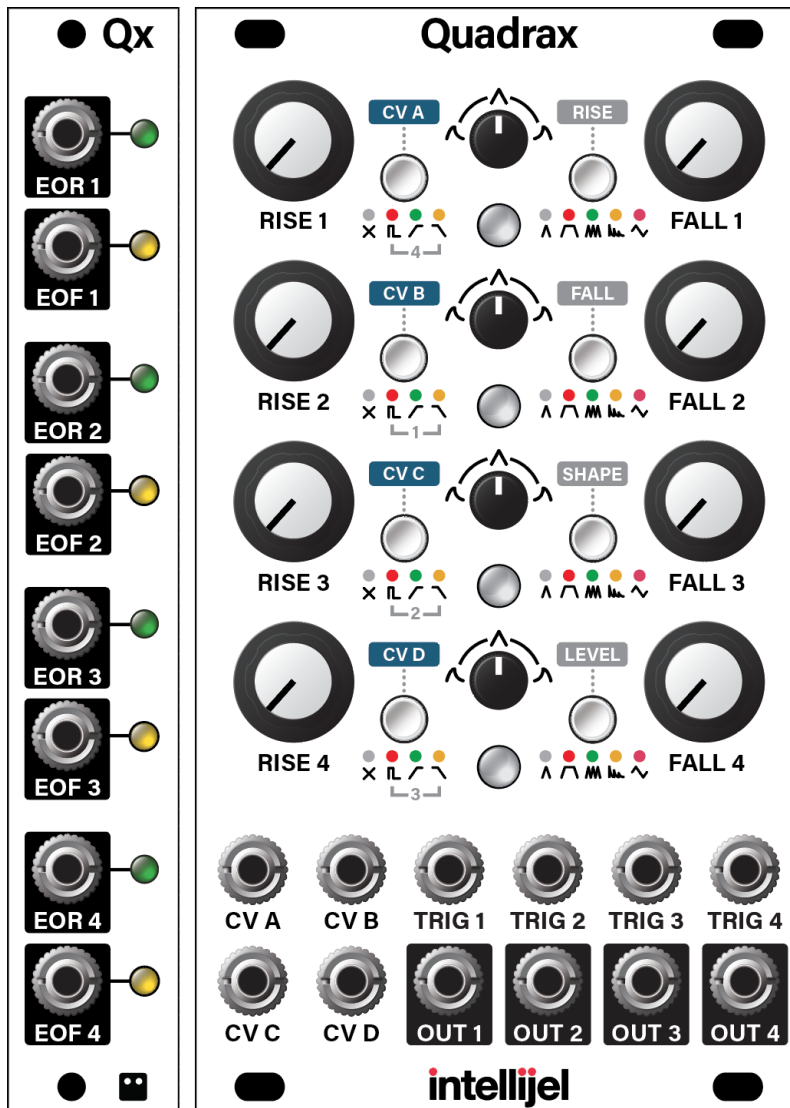

Table of Contents

Table of Contents	1
Compliance	3
Installation	4
Installing Your Module	5
Connecting the Optional Qx Expander Module	6
Overview	7
Quadrax Front Panel	8
Controls	8
Inputs and Outputs	14
Channel Mode Options	15
AD Mode	15
AHR Mode	15
CYCLE Mode	16
BURST Mode	16
LFO Mode	17
Channel Link Options	18
No Link	18
Trigger Link	18
End Of Rise Link	19
End of Fall Link	19
Multiple Triggers	20
Burst Mode	21
LFO Mode	23
Multiple Beat Synchronized LFOs	25
LFO Waveshapes and Morphing	26

Making CV Assignments	27
Enter/Exit CV Assignment Mode	27
Programming the CV Matrix	28
The possible destinations (per channel) are (from top button to bottom):	28
Clearing CV Assignments	31
Using the Optional Qx Module	32
EOR/EOF for AD Mode	32
EOR/EOF for AHR Mode	33
EOR/EOF for CYCLE Mode	33
EOR/EOF for BURST Mode	34
EOR/EOF for LFO Mode	34
Firmware Version Display	35
Firmware Change Log	36
Technical Specifications	37

Compliance



This device complies with Part 15 of the FCC Rules. Operation is subject to the following two conditions: (1) this device may not cause harmful interference, and (2) this device must accept any interference received, including interference that may cause undesired operation.

Changes or modifications not expressly approved by Intellijel Designs, Inc. could void the user's authority to operate the equipment.

Any digital equipment has been tested and found to comply with the limits for a Class A digital device, pursuant to part 15 of the FCC Rules. These limits are designed to provide reasonable protection against harmful interference when the equipment is operated in a commercial environment. This equipment generates, uses, and can radiate radio frequency energy and, if not installed and used in accordance with the instruction manual, may cause harmful interference to radio communications.



This device meets the requirements of the following standards and directives:

EMC: 2014/30/EU

EN55032:2015 ; EN55103-2:2009 (EN55024) ; EN61000-3-2 ; EN61000-3-3

Low Voltage: 2014/35/EU

EN 60065:2002+A1:2006+A11:2008+A2:2010+A12:2011

RoHS2: 2011/65/EU

WEEE: 2012/19/EU

Installation

Intellijel Eurorack modules are designed to be used with a Eurorack-compatible case and power supply. We recommend you use Intellijel cases and power supplies.

Before installing a new module in your case, you must ensure your power supply has a free power header and sufficient available capacity to power the module:

- Sum up the specified +12V current draw for all modules, including the new one. Do the same for the -12 V and +5V current draw. The current draw will be specified in the manufacturer's technical specifications for each module.
- Compare each of the sums to specifications for your case's power supply.
- Only proceed with installation if none of the values exceeds the power supply's specifications. Otherwise you must remove modules to free up capacity or upgrade your power supply.

You will also need to ensure your case has enough free space (hp) to fit the new module. To prevent screws or other debris from falling into the case and shorting any electrical contacts, not leave gaps between adjacent modules, and cover all unused areas with blank panels. Similarly, do not use open frames or any other enclosure that exposes the backside of any module or the power distribution board.

You can use a tool like [ModularGrid](#) to assist in your planning. Failure to adequately power your modules may result in damage to your modules or power supply. If you are unsure, please [contact us](#) before proceeding.

Installing Your Module

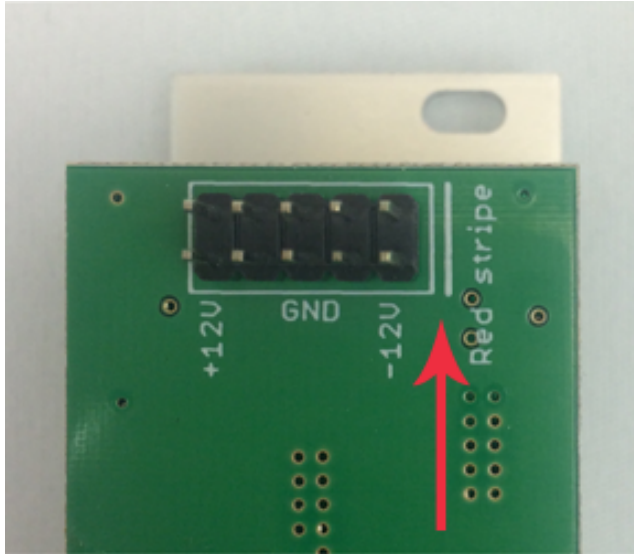

When installing or removing a module from your case always turn off the power to the case and disconnect the power cable. Failure to do so may result in serious injury or equipment damage.

Ensure the 10-pin connector on the power cable is connected correctly to the module before proceeding. The red stripe on the cable must line up with the -12V pins on the module's power connector. Different modules use different ways to indicate the -12V pins. Some may be labelled with "-12V;" a white stripe next to the -12V pins; the words "red stripe;" or some combination of these. Additionally, some modules may have shrouded headers, thus preventing backward connections.

Most modules will come with the cable already connected but it is good to double check the orientation. Be aware that some modules may have headers that serve other purposes so ensure the power cable is connected to the right one.

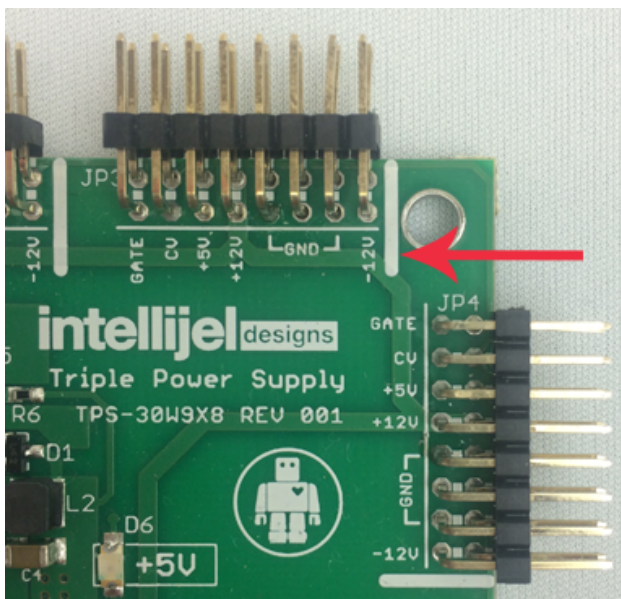

The other end of the cable, with a 16-pin connector, connects to the power bus board of your Eurorack case. Ensure the red stripe on the cable lines up with the -12V pins on the bus board. On Intellijel power supplies the pins are labelled with the label "-12V" and a thick white stripe:

If you are using another manufacturer's power supply, check their documentation for instructions.

Once connected, the cabling between the module and power supply should resemble the picture below:

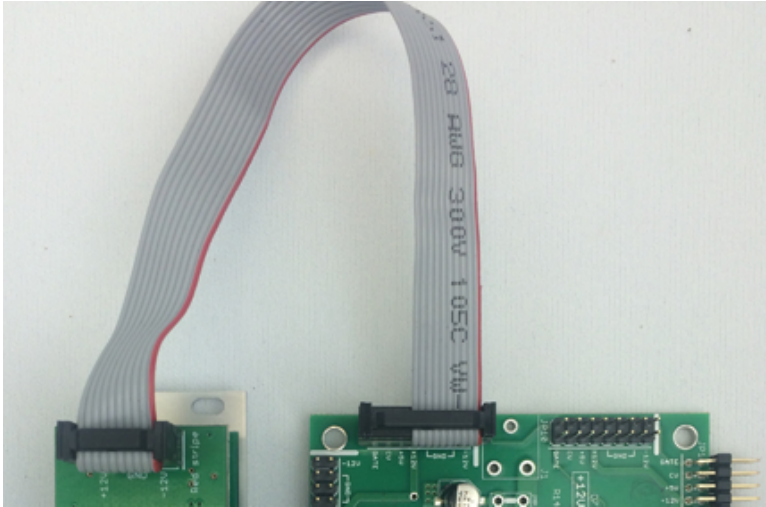

Before reconnecting power and turning on your modular system, double check that the ribbon cable is fully seated on both ends and that all the pins are correctly aligned. If the pins are misaligned in any direction or the ribbon is backwards you can cause damage to your module, power supply, or other modules.

After you have confirmed all the connections, you can reconnect the power cable and turn on your modular system. You should immediately check

that all your modules have powered on and are functioning correctly. If you notice any anomalies, turn your system off right away and check your cabling again for mistakes.

Connecting the Optional Qx Expander Module

Connect the power cable between the 10-pin Qx power connector and one 16-pin power socket on your eurorack system's powered bus board as described above.

Using the I2C cable supplied with your Qx module, connect one end to the 6-pin I2C connector on the Qx and the other end to either of the two I2C ports on your Quadrax module (it doesn't matter which of Quadrax's two I2C ports you use). Be sure to align the red stripe with the white line on the Qx circuit board.

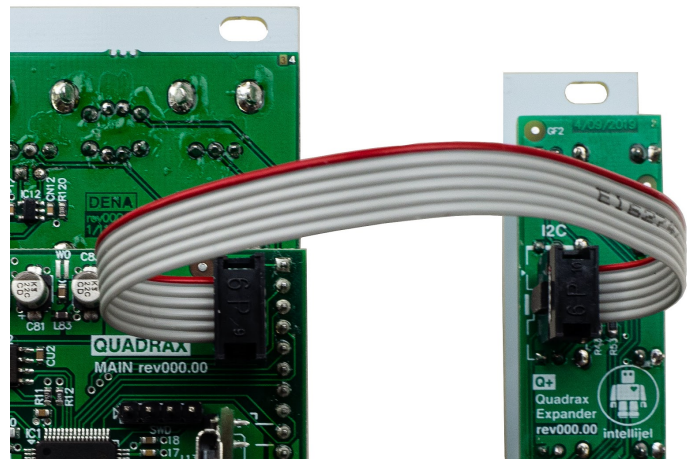

Overview

The Intellijel Quadrax consists of four independent, CV-controllable channels, each of which can be configured to perform any one of the following functions:

- an AD (Attack, Decay) envelope
- an AHR (Attack, Hold, Release) envelope
- a cycling envelope (resulting in a unipolar LFO)
- a pulse burst generator
- a morphing, bipolar LFO

The envelopes all feature a continuously variable response curve, ranging from logarithmic through linear to exponential, and each stage can be as snappy as 0.3 ms to as lengthy as 20 seconds.

When set to Burst mode, the channel generates a rising or falling burst of pulses, with full control over the length of the pulse burst, the number and shape of the bursts within it, and whether the bursts increase or decrease in amplitude over the burst.

AD, AHR, Cycling and Burst modes all feature a user-selectable maximum output level of either 5V or 10V.

LFO mode offers control over the frequency and waveshape, while providing a unique morphing feature that creates numerous variations of the selected waveshape. LFOs can be either free-running or beat-synchronized using the channel's TRIG input.

Channels can be chained together to create complex multi-stage envelopes, with each channel triggered by the previous channel's trigger input, end-of-rise, or end-of-fall. This enables multiple function generators to fire simultaneously, or it enables the creation of complex multi-stage envelopes by allowing the linked function to fire either at the end of the previous function's rise time, or at the end of its fall time.

Four freely-assignable, step-attenuverted CV inputs are capable of modulating any or all of the various parameters across all four channels using the built-in CV matrix, with built-in attenuversion for each assignment.

Quadrax remembers its current state (Mode and CV assignments, channel links, etc) and retains that state even if power is removed, meaning Quadrax will always turn on in exactly the same state as you last left it.

Use the optional Qx module to add individual outputs for each channel's End-of-Rise and End-of-Fall triggers.

Quadrax Front Panel

Controls

1. **RISE (x4)** - Each channel has its own RISE knob, whose function depends on the channel's mode assignment, as selected by the MODE/DESTINATION button [6].

- **AD, AHR and CYCLE** modes: This knob controls the rise time (attack) of the function (rising from zero to the maximum level). Slower times will create a fade-in effect while faster times are used for snappy percussive sounds.

When fully counterclockwise, rise time is about 0.3 ms, slowing to about 50 ms at the 'noon' position. Rotating past noon results in increasingly lethargic rise times, up to about 20 seconds when fully clockwise.

- **BURST Mode:** The RISE knobs sets the overall length of the pulse burst (and, therefore, the rate at which the pulses repeat).

Rotating the knob clockwise increases the length of the pulse burst from about 0.3 ms when fully counterclockwise to around 20 seconds when fully clockwise. Using CV extends the range even further.

- **LFO Mode:** The RISE knob functions as a RATE knob for the LFO.

With nothing patched into the TRIG input, the LFO is free-running and the knob sets the LFO rate from 0.05 Hz (20 sec) when fully counterclockwise to around 3.33 kHz (0.3 ms) when fully clockwise. Using CV extends the range even further.

If you patch a clock into the TRIG input, the LFO will synchronize to the clock, and the RISE knob changes the multiplication/division of the incoming clock. At the 'noon'

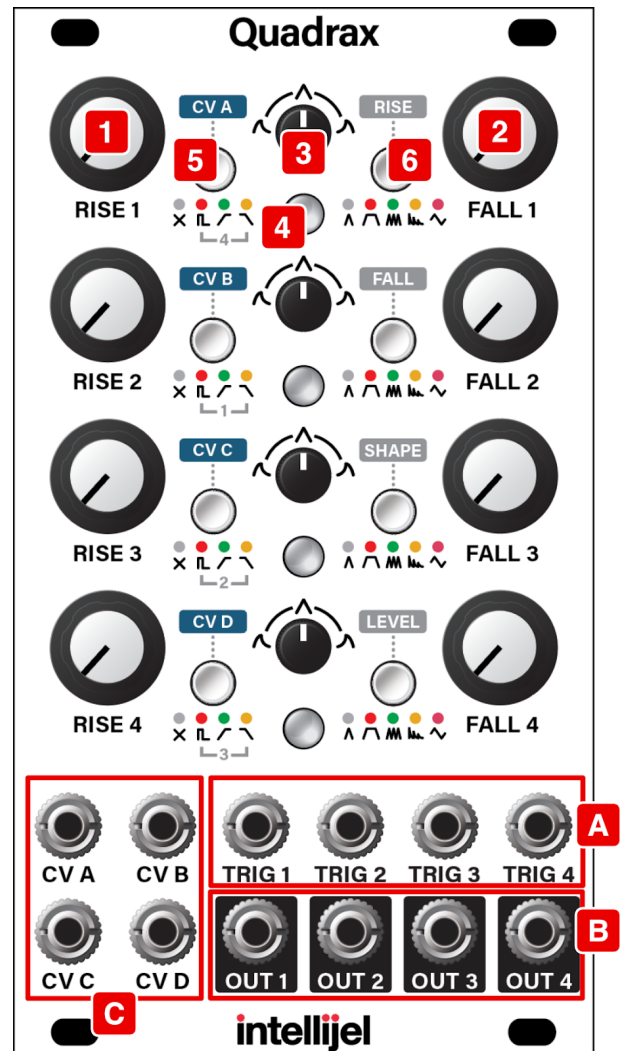

position, the rate equals the incoming clock. Rotating the knob counterclockwise divides the clock, achieving a rate 1/64 of the clock rate when fully counterclockwise. Rotating the knob clockwise multiplies the clock rate, achieving a rate 64 times faster than the incoming clock when fully clockwise. For more information about LFO Mode, see [LFO Mode](#), later.

2. **FALL (x4)** - Each channel has its own FALL knob, whose function depends on the channel's mode assignment, as selected by the MODE/DESTINATION button [6].

- **AD, AHR and CYCLE** modes: Sets the amount of time it takes for the function to fall from its maximum value back to zero. In AHR mode this will act as the release time. In Cycle mode the total time of RISE plus FALL sets the frequency of the cycle.

When fully counterclockwise, fall time is about 0.3 ms, slowing to about 50 ms at the 'noon' position. Rotating past noon results in increasingly lethargic fall times, up to about 20 sec when fully clockwise.

- **BURST Mode:** The FALL knobs sets to the number of pulses contained within the burst. When fully counter-clockwise, Quadrax generates one pulse per burst. When fully clockwise, Quadrax generates 64 pulses per burst. See [BURST Mode](#) later in this manual for more information.

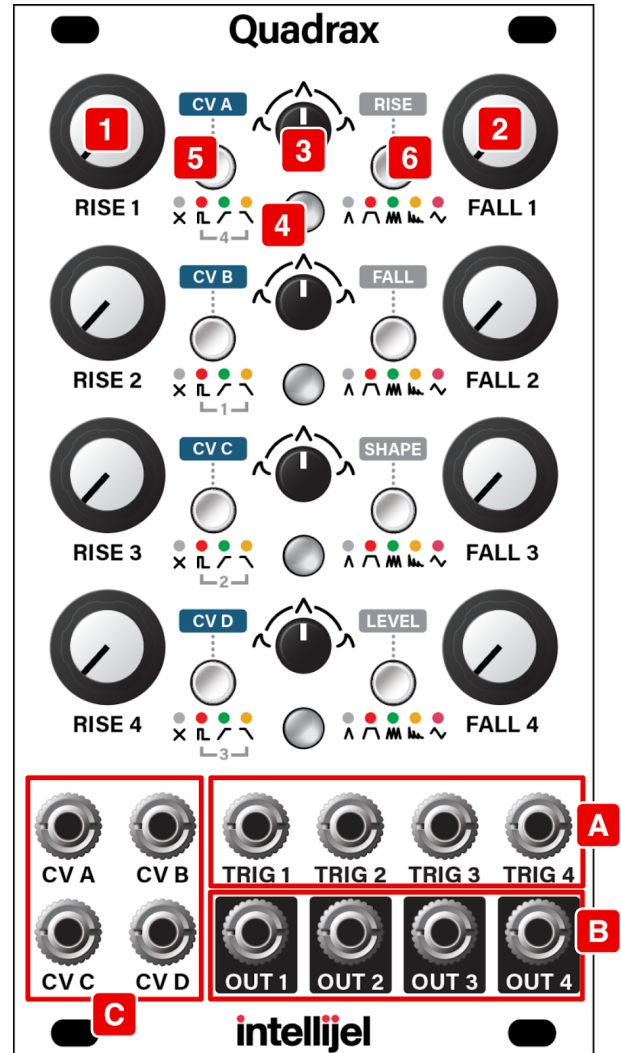

- LFO Mode:** The FALL knob becomes a **MORPH** knob, and is used to create numerous interesting and morphable variations on the basic waveform set by the RESPONSE CURVE knob. These are detailed in the [LFO Waveshapes and Morphing](#) section, later in this manual).
3. **RESPONSE CURVE (x4)** - Each channel has its own RESPONSE CURVE knob, whose function depends on the channel's mode assignment, as selected by the MODE/DESTINATION button [6].
- AD, AHR and CYCLE** modes: This knob changes the shape of the RISE and FALL curves.

At the 'noon' position, the curves are linear, which is traditionally the shape used to control exponential VCAs.

Rotating the knob *clockwise* from center results in an increasingly exponential shape. This is the curve found on many classic envelope generators, and is traditionally used to control linear VCAs. Exponential shapes tend to have more of a plucked character.

Rotating the knob *counterclockwise* from center results in an increasingly logarithmic shape.

The knob's effect on curvature is illustrated to the right.

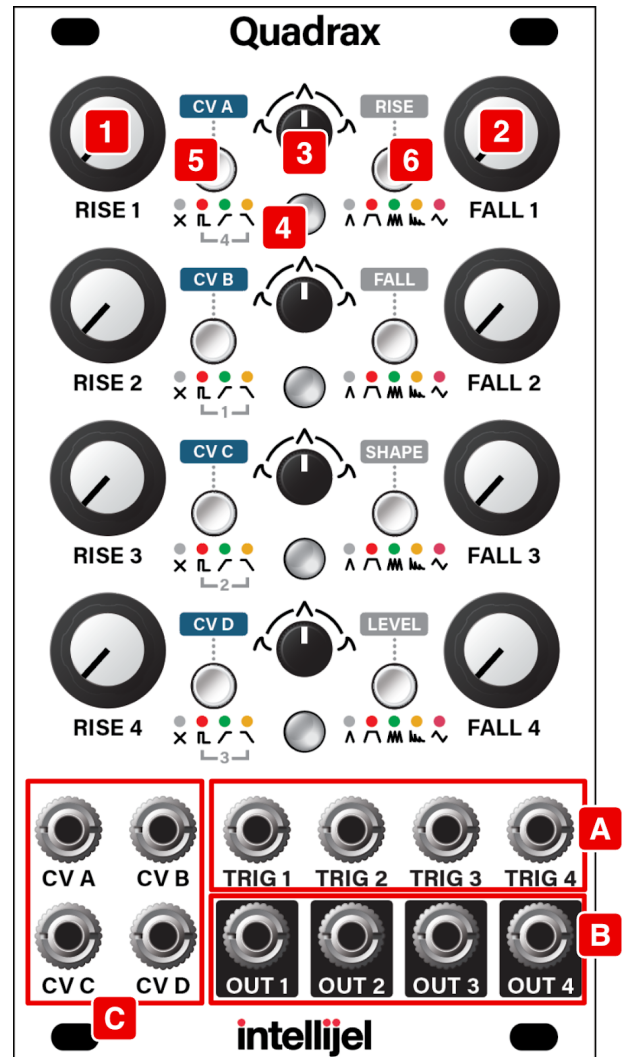
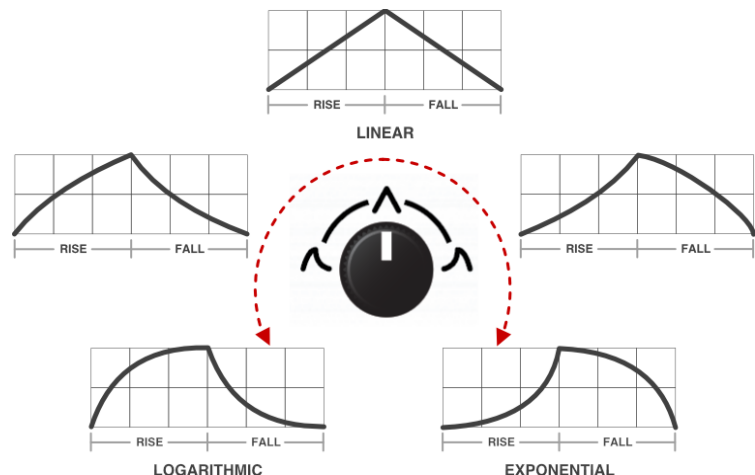

- BURST Mode:** This knob selects the pulse shape and whether the pulse amplitude increases (clockwise from ‘noon’) or decreases (counter- clockwise from ‘noon’) over the burst length. Rising bursts start at 0V and rise to Quadrax’s maximum voltage. Falling bursts start at maximum voltage and decay to 0V. For more information, see the [BURST Mode](#) section, later in this manual.
 - LFO Mode:** The RESPONSE CURVE knob controls the LFO shape, which is further defined by the MORPH (FALL) knob. LFO Mode’s interaction of these two knobs is discussed in [LFO Mode](#), later in this manual.
- LED** - The brighter this LED (x4), the higher the corresponding function generator’s amplitude. If the LED is **green**, then the function is generating a positive voltage. A **red** LED indicates a negative voltage.
 - LINK/CV** button - This button (x4) has two functions, LINK and CV ASSIGN.
 - LINK:** The button’s primary function (as indicated by the graphics beneath) is to determine whether or not the prior channel triggers this channel and, if so, how. Specifically, the LINK button on Channel 2 determines if/how it’s triggered by Channel 1; Channel 3’s button determines if/how its triggered by Channel 2; and Channel 4’s button determines if/how it’s triggered by Channel 3. Channel 1’s button determines if/how it’s triggered by Channel 4. Push a channel’s LINK button repeatedly to cycle through the various triggering options. See [Channel Link Options](#) for more information.
 - CV ASSIGN:** The button’s secondary function (as indicated by the label above it) is to assign the four CV inputs to one or more destinations for each channel. Long-press the LINK/CV button to enter CV Assignment mode. See [Making CV Assignments](#) for more information.

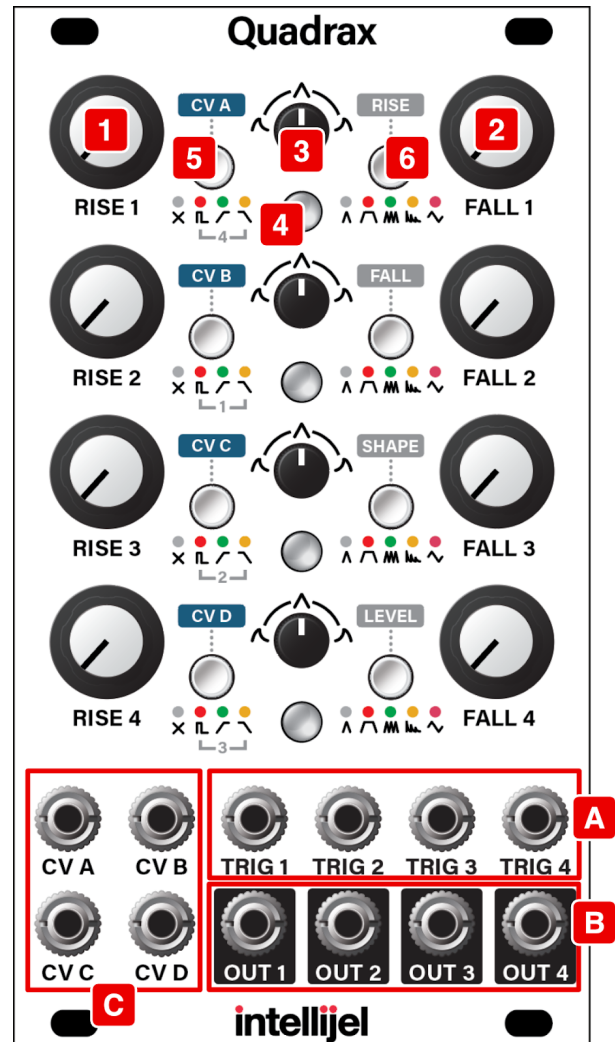

6. **MODE/DESTINATION** button - This button (x4) has two functions: In normal operation, it selects the channel's MODE, while in CV Assignment mode, it sets the DESTINATION (and attenuversion) of the CV input.

When used as a MODE button, it sets each channel to one of five modes. Push the MODE button repeatedly to cycle through the various mode options, which are:

- **AD:** Attack/Decay envelope, where RISE controls the envelope's attack time and FALL controls the decay time. AD envelopes complete their entire cycle upon receiving a trigger at the corresponding TRIG input. AD envelopes ignore the gate time of the incoming signal.
- **AHR:** Attack/Hold/Release envelope, where RISE controls the envelope's attack time and FALL controls its release time. The attack portion of the envelope is triggered by the rising edge of a gate signal sent to the corresponding TRIG input. The envelope holds (sustains) its maximum value for as long as the gate signal is high, then triggers the release stage when the gate signal goes low.
- **CYCLE:** Cycle mode behaves like a unipolar LFO, with the RISE and FALL times determining the rate and shape of the LFO.

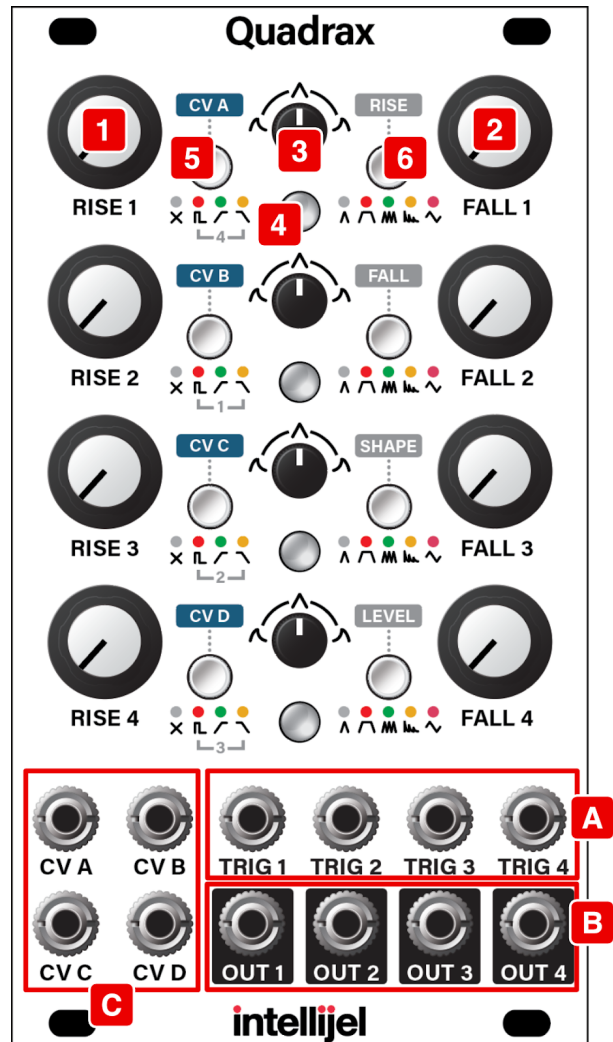

- Burst:** Burst mode generates a definable number of cyclic pulses (using the FALL knob), spaced evenly within a definable length of time (using the RISE knob), whose pulse shapes and overall amplitude curve are defined with the RESPONSE CURVE knob. This mode is discussed thoroughly in [BURST Mode](#), later in this manual.
- LFO:** LFO mode turns a channel into a bipolar, beat-syncable LFO with multiple basic waveshapes and some advanced waveshape morphing capabilities. This mode is discussed thoroughly in [LFO Mode](#), later in this manual.

In CV Assignment mode, this button assigns destinations to CV inputs, and controls the amount of attenuation applied. The brighter the button, the more a CV input affects a destination, with green indicating positive modulation and red indicating negative modulation. The operation of the DESTINATION button is described fully in [Making CV Assignments](#).

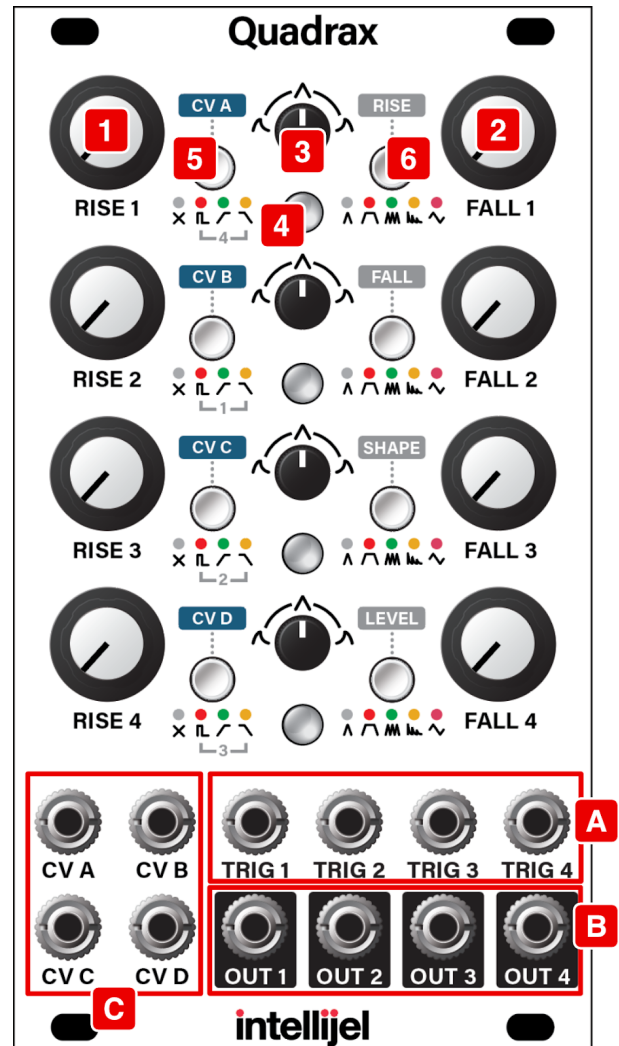

Inputs and Outputs

- A. TRIG Inputs (x4)** - Patch a trigger or gate signal here to launch the function generator. There are four TRIG inputs — one for each of the four function generators.

In LFO mode, the TRIG input functions as a clock input, and the RISE / LFO RATE knob functions as a clock divider/multiplier, allowing beat-synchronized LFOs. Because the TRIG inputs have jack detection, you can have free-running LFOs by simply leaving the TRIG input disconnected.

- B. OUTS (x4)** - Outputs for each of the four channel function generators.

Channels assigned to AD, AHR, CYCLE or BURST modes generate a unipolar control signal. The maximum level can be set to either 5V or 10V, and is toggled by holding down Channel 4's MODE/DESTINATION button while powering on the module.

You can see, during any power up, whether Quadrax is currently set to 10V or 5V. If the maximum output level is currently set to 10V, the [Firmware Version Display](#) LEDs are **blue** upon boot. If the maximum output level is currently set to 5V, the Firmware Version Display LEDs are **green** upon boot. Quadrax ships from the factory with an output voltage of 5V.

Channels assigned to LFO mode generate a bipolar signal (-5V to +5V).

- C. CV Inputs (x4)** - Patch control voltages into each jack to modulate one or more user-definable parameters for any or all of the four channels. Each CV input can control multiple destinations, and with varying amounts of attenuation for each. For more information, see [Making CV Assignments](#).

NOTE: Although the range of CV modulation is ±5V, the CV inputs accept voltages up to ±10V. Any voltages above or below 5V are simply clipped at ±5V. Use Quadrax's internal attenuverters (as described in [Programming the CV Matrix](#)) to dial down the input voltages.

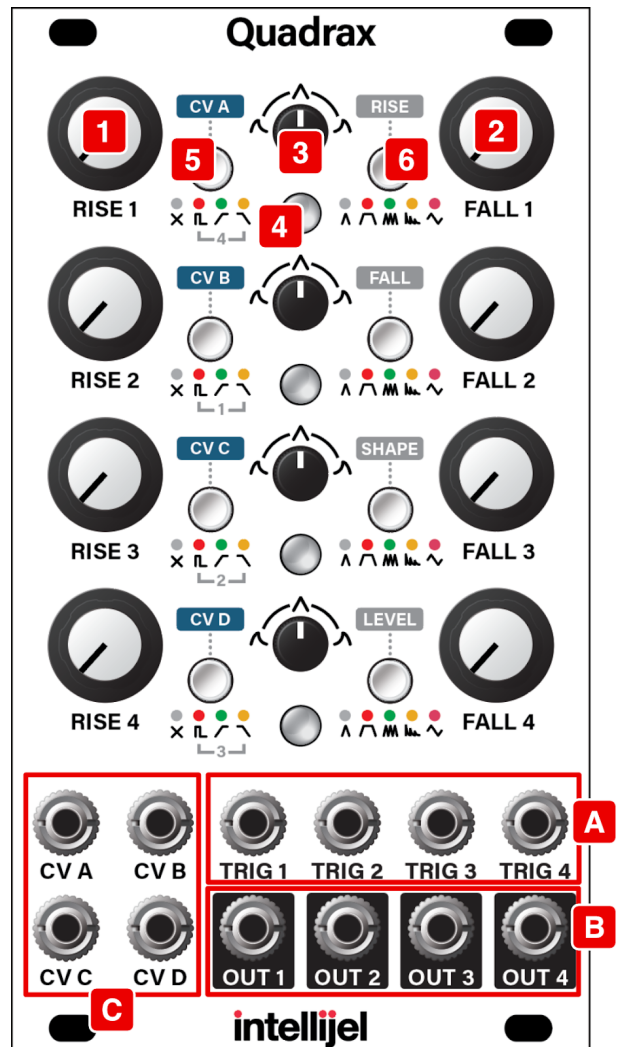

Channel Mode Options



Each of Quadrax's four channels can be assigned to operate in one of five modes: Pushing the MODE button repeatedly cycles through the various mode options.

AD Mode

When the MODE button is unlit, the channel is a classic, 2-stage Attack/Decay envelope, where **RISE** controls the envelope's attack time and **FALL** controls the decay time. AD envelopes complete their entire cycle upon receiving a trigger at the corresponding **TRIG** input. AD envelopes ignore the gate time of the incoming signal.

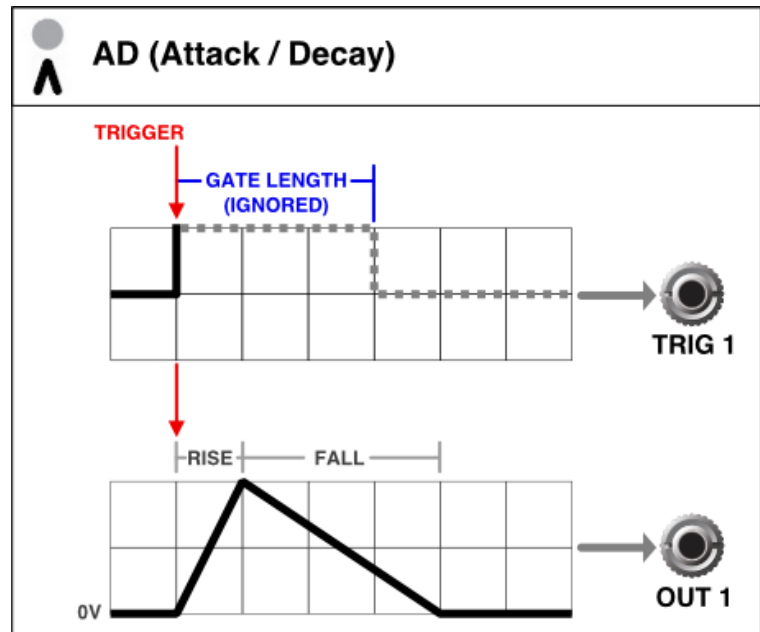

AHR Mode

When the MODE button is **red**, the channel acts as an Attack/Hold/Release envelope, where **RISE** controls the envelope's attack time and **FALL** controls its release time. The attack portion of the envelope is triggered by the rising edge of a gate signal sent to the corresponding **TRIG** input. The envelope holds (sustains) its maximum value for as long as the gate signal is high, then triggers the release stage when the gate signal goes low. If the gate length is shorter than the rise time, the envelope will begin to fall before reaching its maximum value.

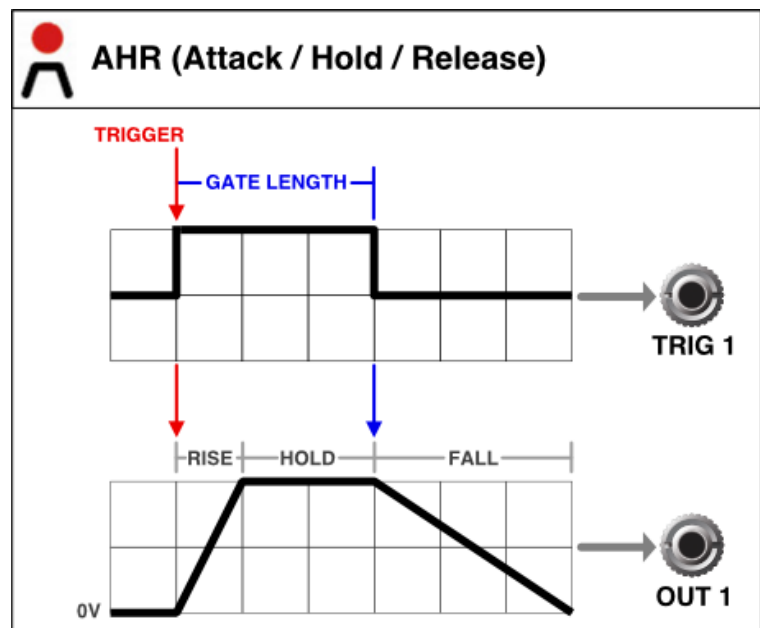

CYCLE Mode

When the MODE button is **green**, the channel produces a cycling AD envelope, which behaves like a unipolar LFO. The frequency of the cycle is determined by the overall sum of the **RISE** and **FALL** times. The skewing of the cycle is determined by the relative amounts of RISE and FALL, while the curvature is selected by the **RESPONSE CURVE** knob.

The Cycle is free running, and does not require a **TRIG** input. However, if a TRIG input is detected, then the Cycle resets, as shown in the graphic to the right. GATE times are ignored.

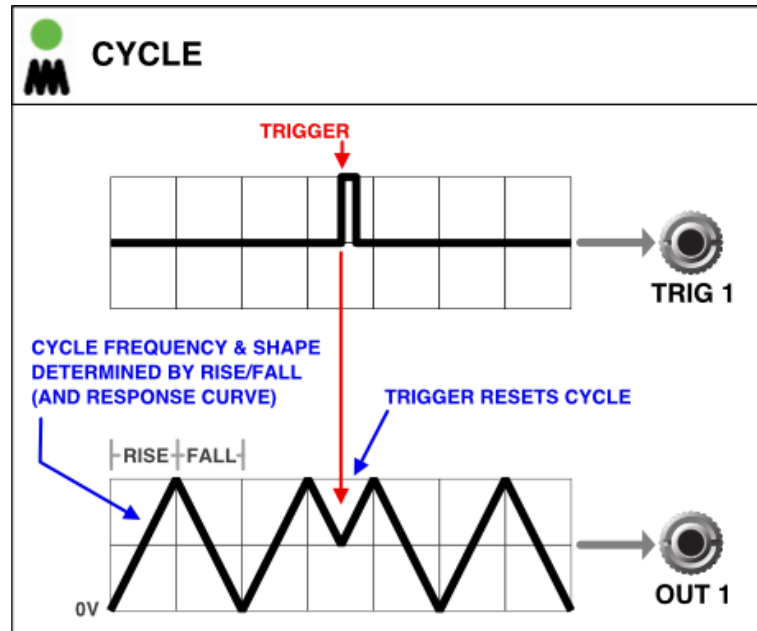

BURST Mode

When the MODE button is **yellow**, the channel operates in BURST mode. Burst mode generates a definable number of cyclic pulses (using the **FALL** knob), spaced evenly within a definable length of time (using the **RISE** knob), whose shape and amplitude curve are defined with the **RESPONSE CURVE** knob.

For more information, see [Burst Mode](#), later in this manual.

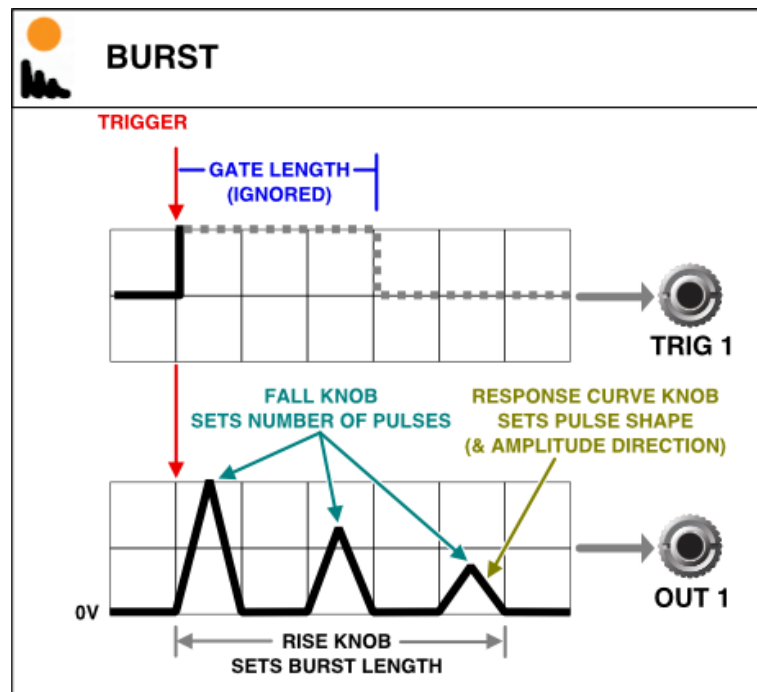

LFO Mode

When the MODE button is **magenta**, the channel operates in LFO mode. In this mode, the channel becomes a bipolar LFO, with the RISE knob controlling LFO **RATE**, the RESPONSE CURVE knob selecting **WAVESHAVE**, and the FALL knob controlling a **MORPH** function that varies the waveshape. For more information, see [LFO Mode](#) later in this manual.

LFOs can be beat-synchronized using the channel's TRIG input, or they can be free-running if the TRIG input is left unpatched.

Clocked LFO: Send a clock to the channel's TRIG input and use the RATE (RISE) knob to multiply or divide that rate by as much as 64x in either direction. With the RATE knob straight up ('noon' position), the LFO rate equals the clock rate.

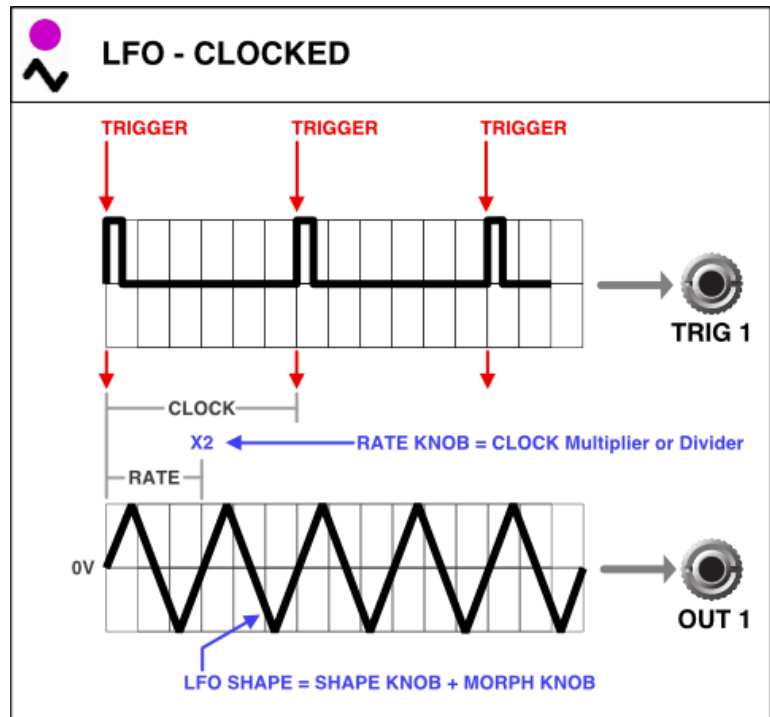

Unclocked LFO: Leave the channel's TRIG input unpatched and use the RATE (RISE) knob to dial in the desired free-running rate. LFO frequency can be set from 0.05 Hz (20 sec) when fully counterclockwise to around 3.33 kHz (0.30 ms) when fully clockwise. Using CV extends the range even further.

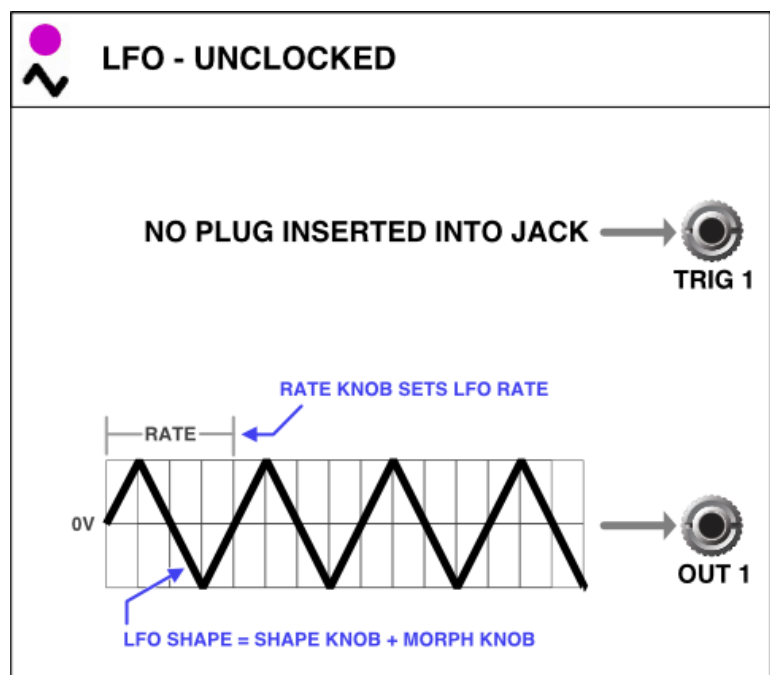

Channel Link Options

Though it's perfectly acceptable to think of Quadrax as four completely independent function generators, the module features several ways to link these channels together. Use the LINK button (together with the TRIG inputs) to fire off multiple functions with a single trigger, or to create complex envelope shapes and rhythms using multiple triggers. Pushing the LINK button repeatedly cycles through the various channel link options.



No Link

When the LINK button is unlit, channel triggering is completely independent of the channel that precedes it, and is controlled entirely by its own TRIG input.

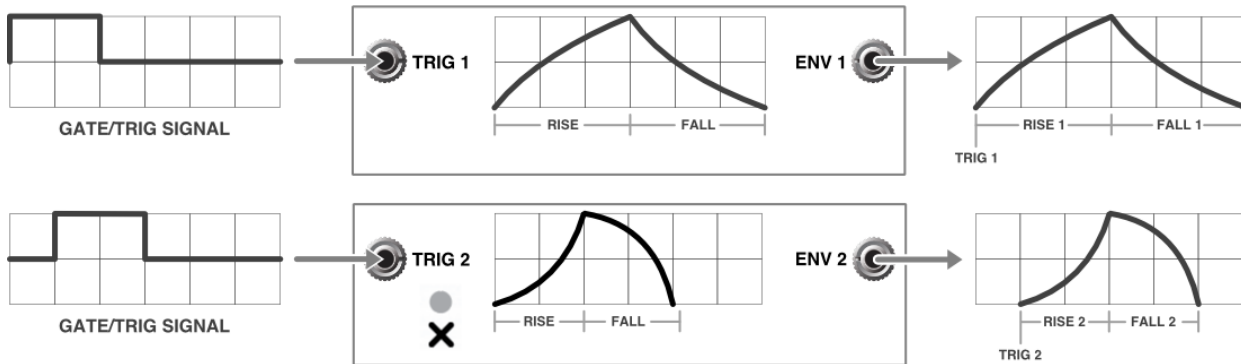

Trigger Link

When the LINK button is **red**, channel triggering is normalled to the previous envelope's TRIG input. This lets you trigger two entirely different functions with a single trigger, which is useful (for example) when you want a keyboard or sequencer to trigger multiple envelopes with a single note event (such as one envelope for your VCA and a second envelope for your filter).

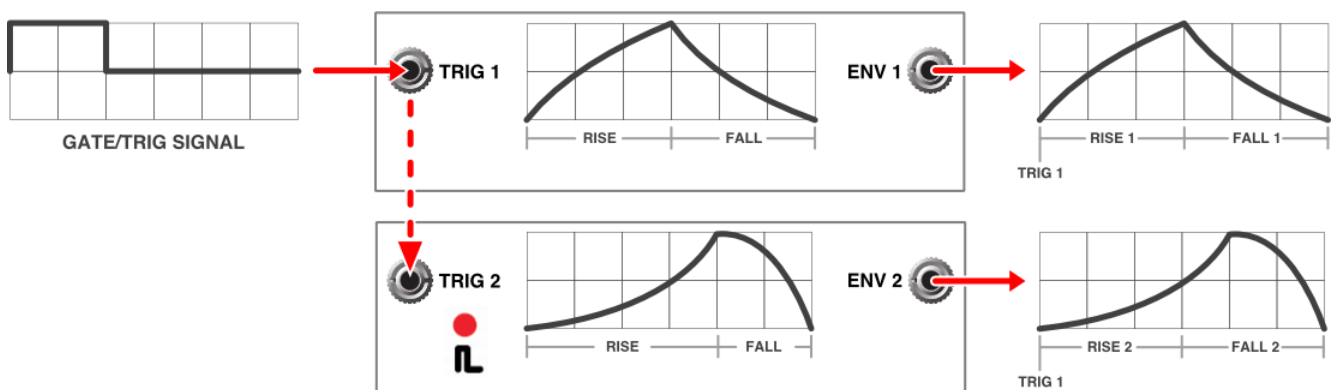

End Of Rise Link

When the LINK button is **green**, the channel is triggered when the previous channel's function completes its RISE time.

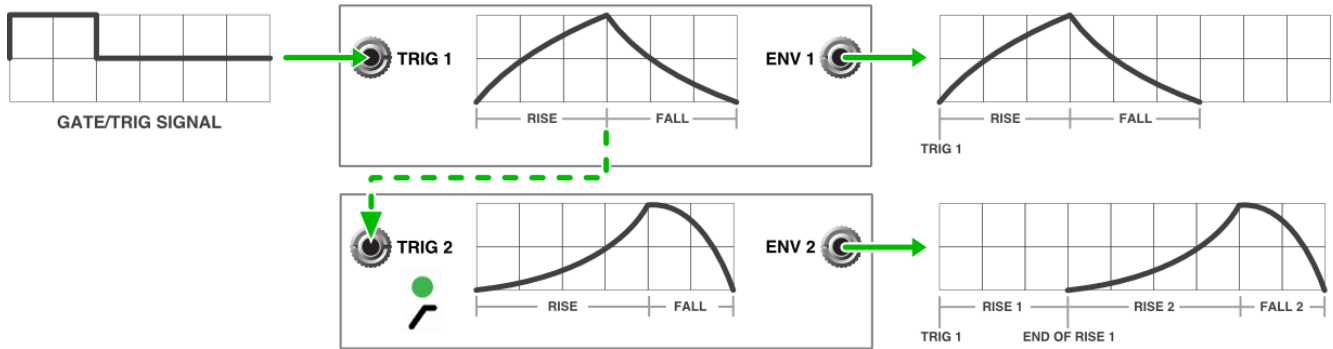

While the meaning of “End of Rise” (EOR) is obvious for envelope-based functions (such as AD, AHR and CYCLE), it may be less obvious how a channel is triggered by the EOR of a [BURST](#) or [LFO](#) channel. BURST mode triggers an EOR at the beginning of every pulse within the burst. LFO mode triggers an EOR every time the LFO completes half its cycle. For a complete description of exactly when EOR and EOF are triggered for each of Quadrax’s five modes, see [Using the Optional Qx Module](#), later in this chapter.

End of Fall Link

When the LINK button is **yellow**, the channel is triggered when the previous channel's function completes its FALL time.

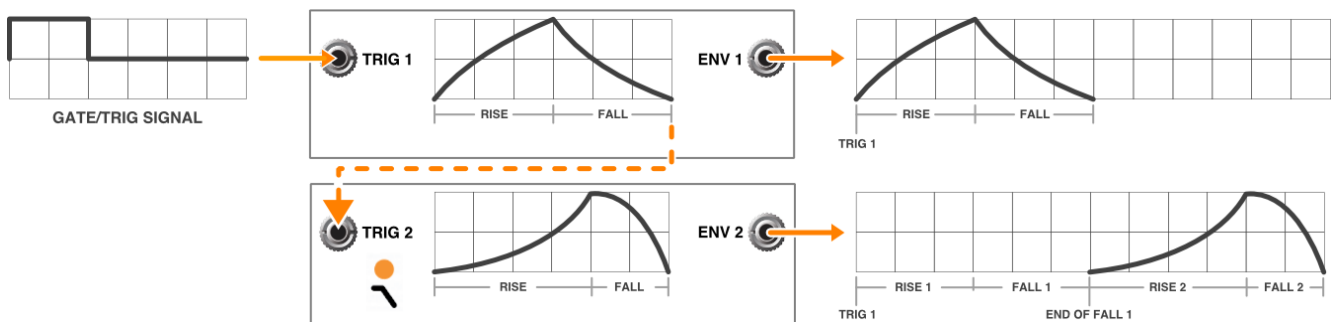

While the meaning of “End of Fall” (EOF) is obvious for envelope-based functions (such as AD, AHR and CYCLE), it may be less obvious how a channel is triggered by the EOF of a [BURST](#) or [LFO](#) channel. BURST mode triggers an EOF at the end of every burst length. LFO mode triggers an EOF every time the LFO completes a full cycle. For a complete description of exactly when EOR and EOF are triggered for each of Quadrax’s five modes, see [Using the Optional Qx Module](#), later in this chapter.

Multiple Triggers

If you use one of the linked triggering options combined with the channel's own TRIG input, then the two trigger sources are OR'd together — meaning the function will fire whenever it gets a trigger signal from its own TRIG input as well as from the previous channel.

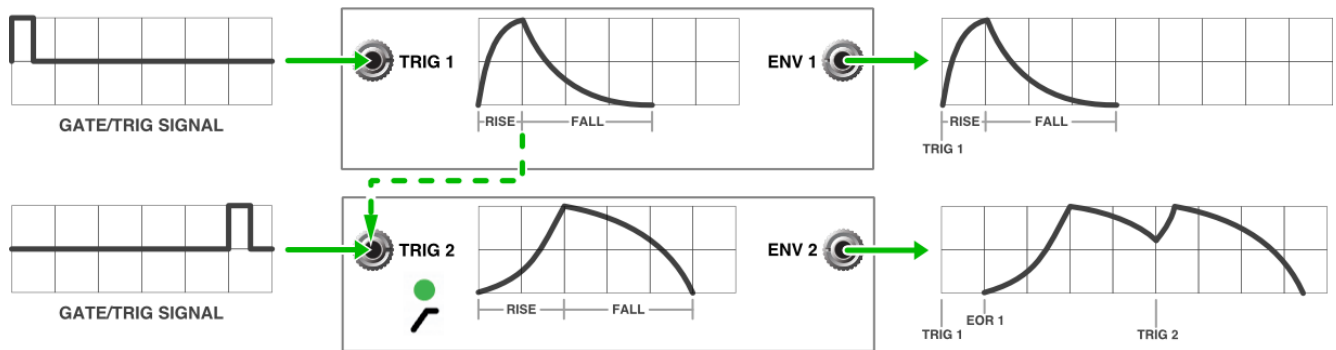

Burst Mode

Repeatedly press the **MODE** button [1] to cycle through the various channel modes, stopping when the button turns **yellow** (indicating Burst mode). When set to Burst mode, the channel generates a rising or falling burst of pulses, which appears at the channel's corresponding **OUT [B]** jack.

The channel's **TRIG** input [A] triggers the pulse burst.

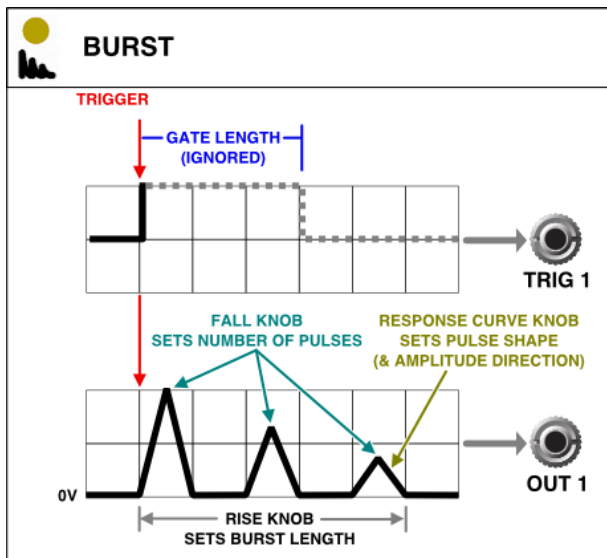

In Burst mode, Quadrax's controls take on the following functions:

[3] RISE (LENGTH) knob: In Burst mode, the RISE knob functions as the LENGTH knob. It sets the length of the pulse burst (and, therefore, the rate at which the pulses repeat). Rotating the knob clockwise increases the length of the pulse burst from about 0.3 ms when fully counterclockwise to around 20 seconds when fully clockwise. Using CV extends the range even further.

[4] FALL (PULSES) knob: In Burst mode, the FALL knob functions as the PULSES knob. It sets the number of pulses generated during the length of the pulse burst. Rotating the knob clockwise increases the number of pulses from 1 (when fully counterclockwise) to 64 (when fully clockwise). Pulses are always spaced equally throughout the length of the burst. Therefore, if you change the burst length, you'll change the frequency of the pulses being produced.

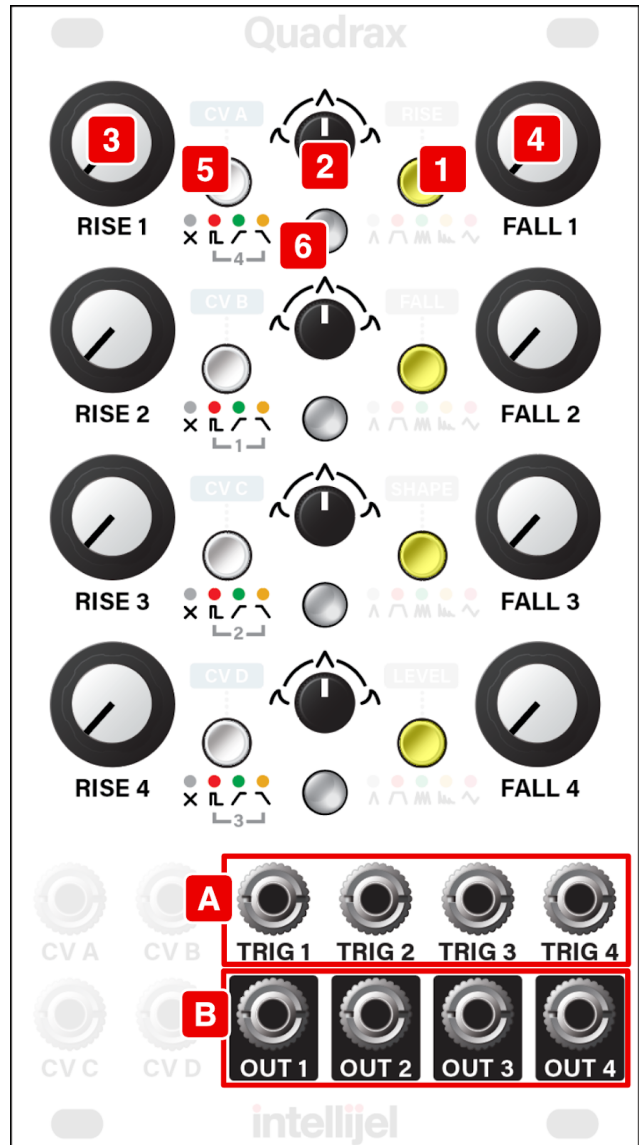

[2] RESPONSE CURVE (SHAPE) knob: In Burst mode, the RESPONSE CURVE knob becomes the SHAPE knob (as indicated by the graphic above the knob). It selects the pulse shape (and whether the pulse amplitude increases or decreases over its length, as shown in the graphic below). Rising bursts start at 0V and rise to their maximum level (either 5V or 10V, as toggled by holding down Channel 4's MODE/DESTINATION button while powering on the module). Falling bursts start at maximum voltage and decay to 0V.

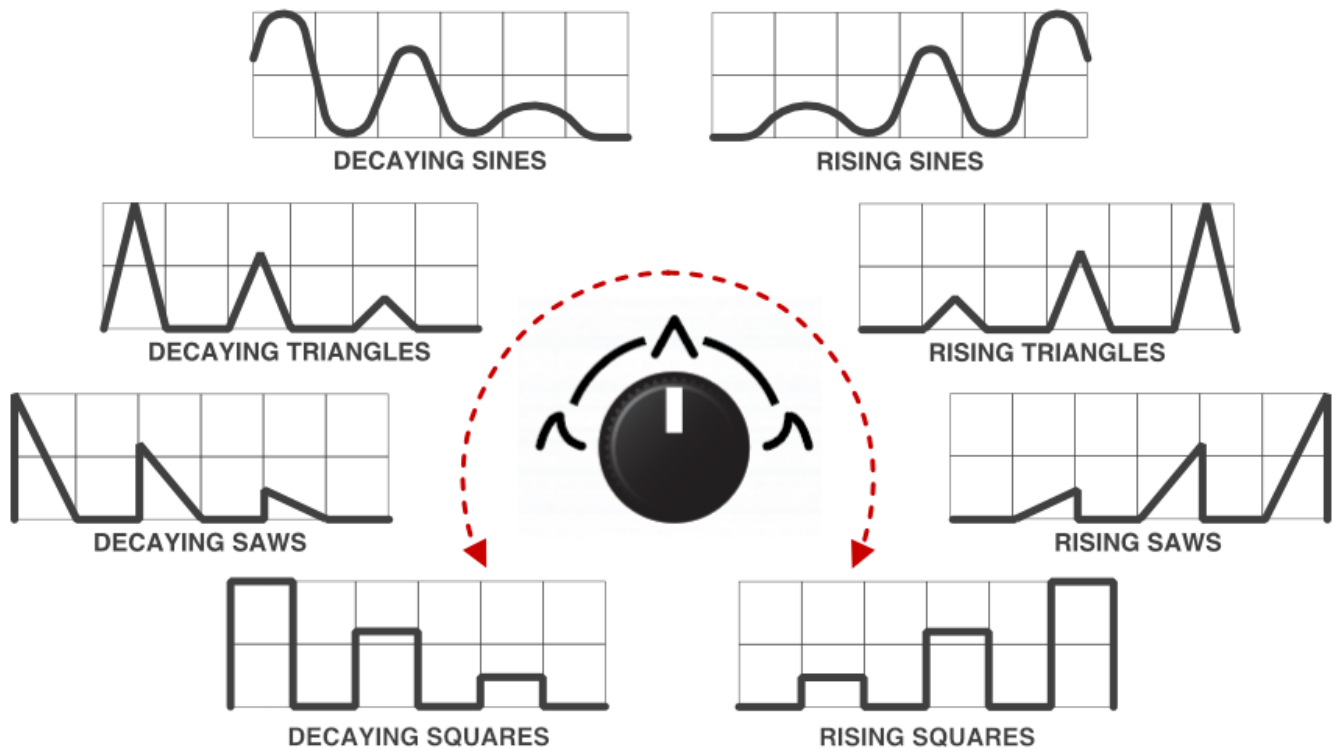

[5] LINK button: A burst can be retrigged in various ways using the **LINK** button **[5]** to connect it to the previous channel's EOR or EOF trigger.

[6] LED: Each pulse's intensity and the rate at which they fire can be monitored using this LED. The LED is **green**, indicating that the pulses are positive voltage, and the intensity of the LED indicates the absolute voltage of each pulse (higher voltage = brighter LED).

LFO Mode

Repeatedly press the **MODE** button [1] to cycle through the various channel modes, stopping when the button turns **magenta** (indicating LFO mode). When set to LFO mode, a channel becomes a bipolar LFO, which appears at the channel's corresponding **OUT [B]** jack.

The channel's **TRIG** input [A] can be used as a clock input for beat-synchronized LFOs, or it can be left unpatched for free-running LFOs.

In LFO mode, Quadrax's controls take on the following functions:

[2] RESPONSE CURVE (SHAPE) knob: In LFO mode, the RESPONSE CURVE knob functions as a SHAPE knob. This knob sweeps through variants of five basic LFO waveshapes (detailed in the [LFO Waveshapes and Morphing](#) section, below).

[3] RISE (RATE) knob: In LFO mode, the RISE knob functions as a RATE knob. It's used to set the LFO rate (or a division/multiplication of any clock present at the channel's TRIG input).

If the LFO is free-running (TRIG input unpatched), then rotating the RATE/RISE knob clockwise increases the LFO rate from 0.05 Hz (20 s) when fully counterclockwise to around 3.3 kHz (0.30 ms) when fully clockwise. Using CV extends the range even further.

If the LFO is beat-synchronized (clock sent to TRIG input), then rotating the RATE/RISE knob changes the multiplication/division of the incoming clock. At the noon position (straight up), the knob sets the LFO rate equal to the incoming clock rate. Rotating the knob counterclockwise divides the clock, achieving a rate 1/64 of the clock rate when fully counterclockwise. Rotating the knob clockwise multiplies the clock rate, achieving a rate 64 times faster than the incoming clock when fully clockwise.

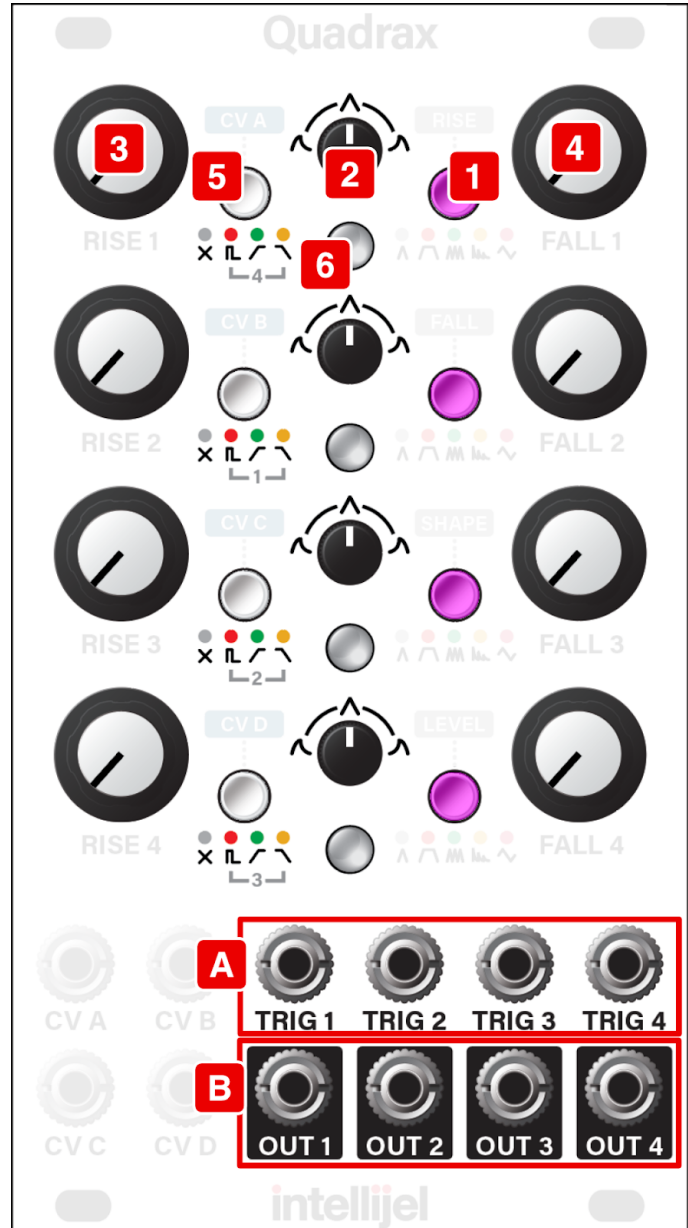

[4] FALL (MORPH) knob: In LFO mode, the FALL knob becomes the MORPH knob. It's used to create numerous interesting and morphable variations on the basic waveform set by the central SHAPE knob. These variations are detailed in the [LFO Waveshapes and Morphing](#) section, below).

[5] LINK button: An LFO can be retriggered in various ways using the **LINK** button [5] to connect it to the previous channel's EOR or EOF trigger.

If you set a channel to LFO mode, and link it to the previous channel, then the LFO is reset by the previous channel's TRIG input, EOR or EOF.

For example, assume Channel 1 is set to AD mode, and Channel 2 is set to LFO Mode and is linked to Channel 1's EOR (End of Rise). In this scenario, Channel 2's LFO will reset every time it gets an EOR from Channel 1's envelope.

Additionally, if you assign multiple channels to LFO Mode and link them, you can trigger multiple beat-synchronized LFOs with a single clock input, as shown in [Multiple Beat Synchronized LFOs](#), below.

[6] LED: The LFO's intensity, polarity and rate can be monitored using the two LEDs [6]. A **green** LED indicates the LFO is outputting a positive voltage and a **red** LED indicates a negative voltage.

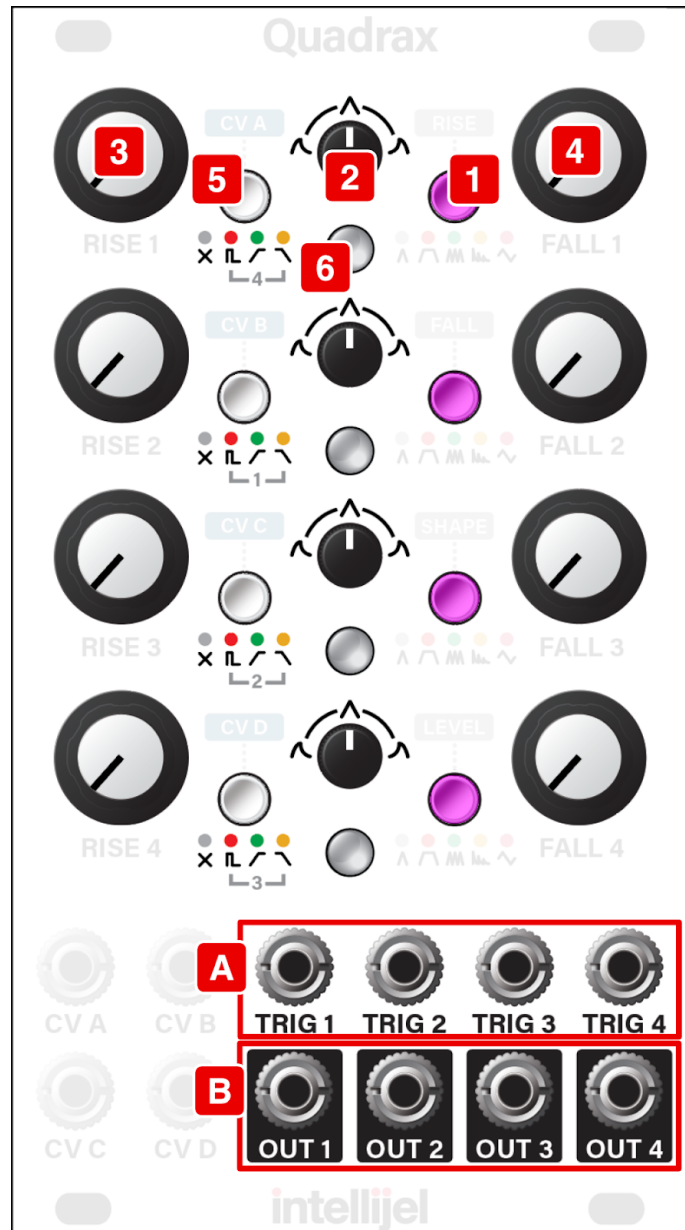

Multiple Beat Synchronized LFOs

Here's an example of how you can beat-synchronize multiple LFOs using a single **TRIG** input:

1. Set Channels 1 and 2 to LFO mode by pressing each channel's **MODE** button [1] until it's **magenta**.
2. Link Channel 2's Trigger to Channel 1's by pressing Channel 2's **LINK** button [5] until it turns **red**.
3. Patch a clock into **TRIG 1**.
4. Use Channel 1's **RISE(RATE)** knob [3] to set the LFO 1 rate to some multiplication or division of the incoming TRIG 1 clock.
5. Use Channel 2's **RISE(RATE)** knob [3] to set the LFO 2 rate to some other multiplication or division of the same incoming clock.
6. For each channel, use the **RESPONSE CURVE (SHAPE)** knob [2] and **FALL (MORPH)** knob [4] to set its LFO waveshape (as discussed further in the next section).

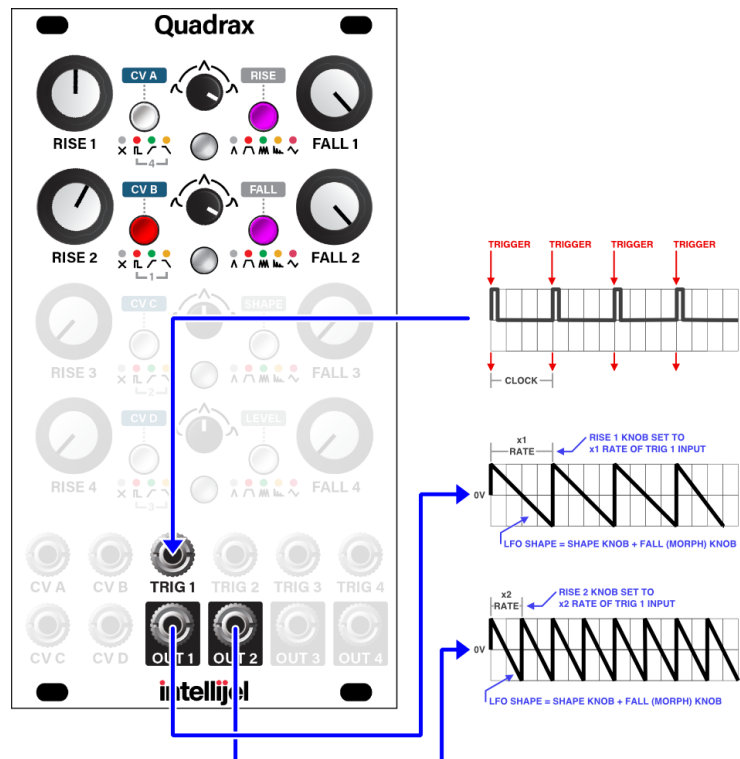

LFO Waveshapes and Morphing

The following chart shows how the FALL (MORPH) knob [4] and the CURVE (SHAPE) knob [2] work together to create numerous LFO waveshapes. All shapes are continuously variable, and the examples shown here are merely snapshots.

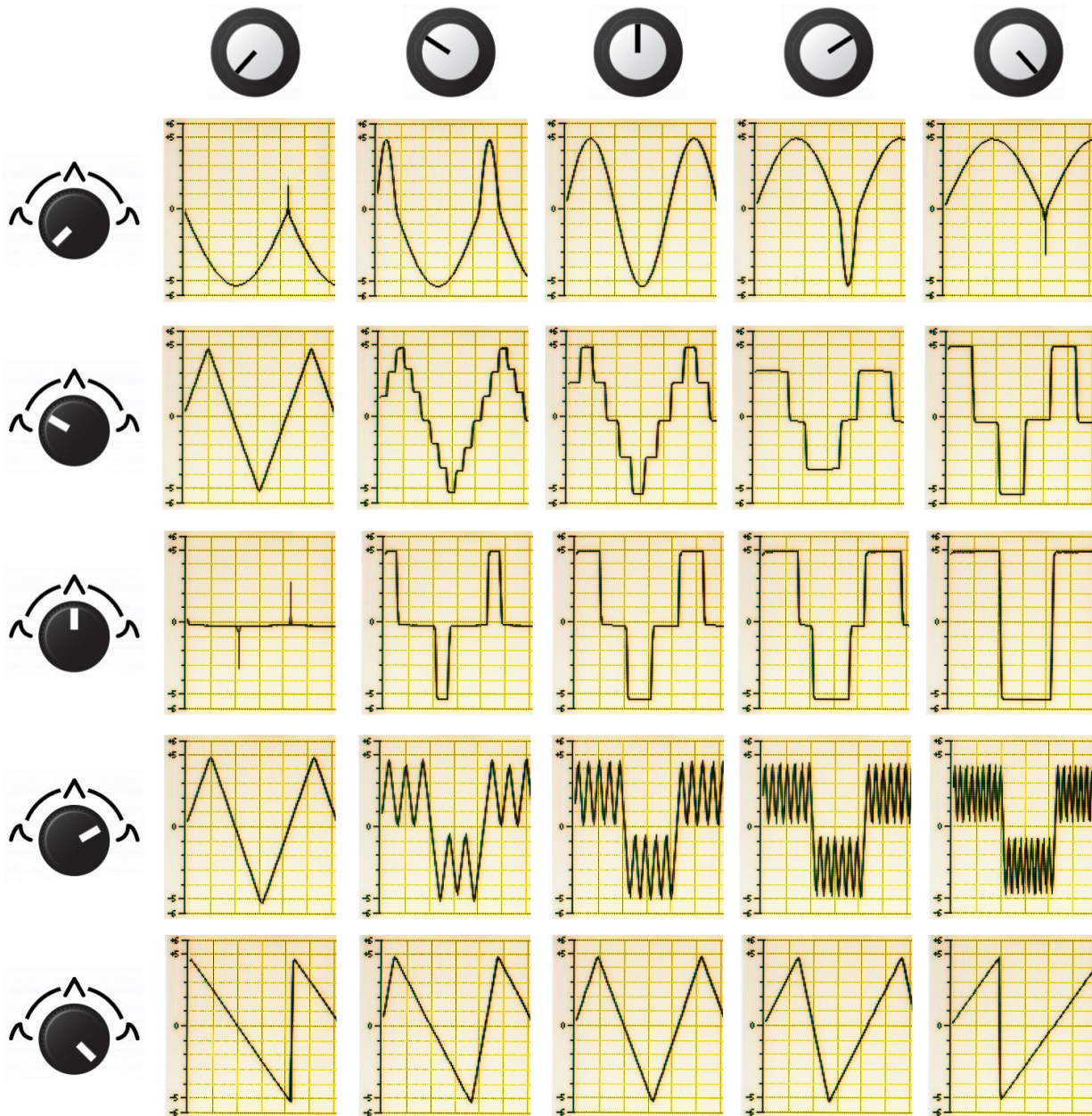

Making CV Assignments

Quadrax's **LINK** and **MODE** buttons have a dual purpose, which is to assign each of the module's four CV inputs to one or more destinations, and to attenuvert them as needed. CV assignment functions are written *above* the buttons.

CV assignments are made in Quadrax's CV Assignment mode, which enables access to a fully programmable CV matrix, with which you can freely assign any or all of the four CV inputs to control any or all of four possible destinations for any or all channels.

Enter/Exit CV Assignment Mode

Each of Quadrax's four channels has its own CV assignment mode. To enter it:

1. Long-press (>1 sec) the LINK/CV button for the channel to which you want to assign CV control.

For example, to assign CV inputs to Channel 1, long-press the top LINK/CV button. To assign CV inputs to Channel 2, long-press the LINK/CV button in the second row, etc.

The active channel's CV button flashes **magenta** to indicate Quadrax is in CV assignment mode, and that all CV input/output assignments will be made on that channel.

2. To make CV assignments on a different channel, long-press the LINK/CV button corresponding to another desired channel.

That button flashes **magenta** to indicate you are now assigning CVs to the channel on this row.

3. To exit CV assignment mode, long-press (>1 sec) whichever LINK/CV button is currently flashing **magenta**.

When in CV Assignment mode, you can freely assign any of the four available CV inputs to control any or all of four destination parameters on each of the four channels using Quadrax's CV Matrix, described below.

Programming the CV Matrix

For each channel, you can assign any or all of the CV inputs to any or all modulation destinations. Furthermore, you can attenuvert the amount of CV used to modulate each destination. In theory, you could route each of the four CV inputs to 16 destinations simultaneously (4 destinations per channel) — each attenuverted as needed.

The possible destinations (per channel) are (from top button to bottom):

- Rise time
- Fall time
- Shape
- Level (envelope/LFO amplitude)

To program the CV Matrix:

1. Enter CV assignment mode by long-pressing the LINK/CV button next to the channel to which you'd like to apply CV control.

For example, if you want to assign CV control to Channel 1, long-press Channel 1's LINK/CV button.

The active channel (to which you will make CV assignments) is indicated by a flashing **magenta** CV button.

2. Press the CV button corresponding to the CV input you wish to assign (as indicated by the text *above* the button).

For example, if you want CV B to modulate some parameter, press the **CV B** button. It will glow **blue** to indicate that it's active.

3. Press the MODE/DESTINATION button corresponding to the parameter you wish to modulate: RISE, FALL, SHAPE, or LEVEL.

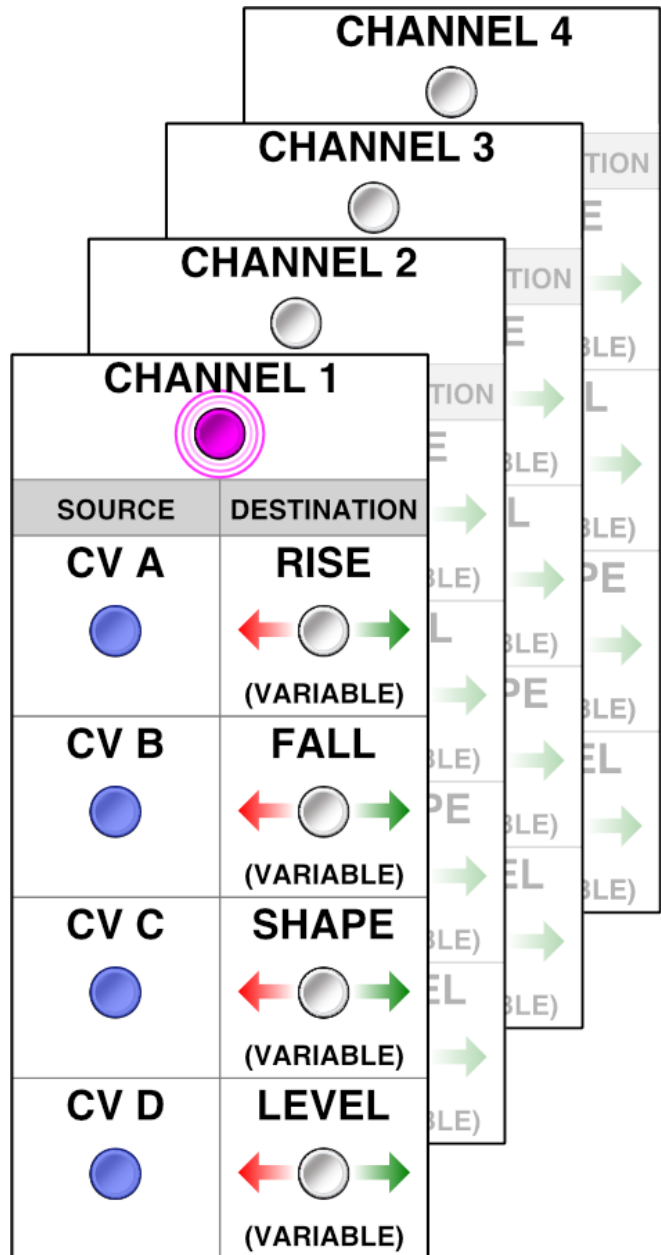

4. Repeatedly press the MODE/DESTINATION button to change the amount by which the input CV affects the parameter.

There are four levels of attenuation, indicated by the brightness of the button. A fully lit button indicates 100% of the CV input value is used to modulate the parameter. The button grows progressively dimmer as more attenuation is applied (meaning CV has less effect on the destination). To disable CV control of a destination, repeatedly press the destination button until the button light extinguishes.

5. To invert the effect of the CV input, long-press (>1 sec) the MODE/DESTINATION button.

The destination button glows **red** when the CV input is inverted, and **green** when it is not. The same four levels of attenuation are available for inverted CV, giving you 8 possible attenuverted levels, plus “off” (no CV control over the parameter).

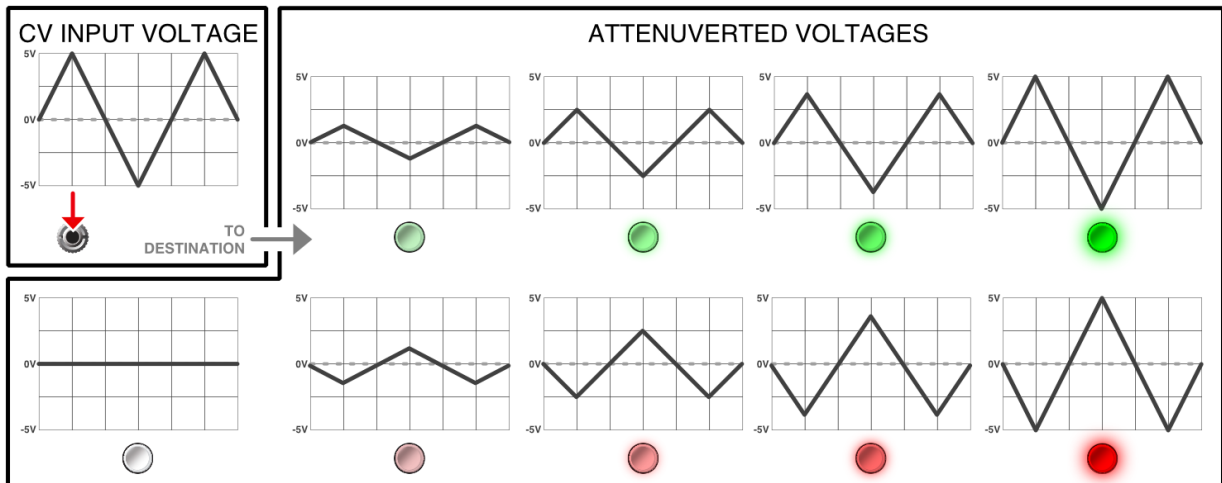

6. Repeat steps 3-5 to assign the CV input to more destinations (if you wish) and to attenuvert them accordingly.
7. If you wish to assign another CV input, press the **CV** button corresponding to the CV input you next wish to configure, and follow steps 3-5 to assign its modulation destination(s).
8. If you wish to make CV assignments on a different channel, long-press the LINK/CV button corresponding to the channel you next wish to configure (the active channel will flash **magenta**), and follow steps 2-7 to configure its CV inputs.

Here is a recap of what the various button colors indicate in CV Assignment mode:

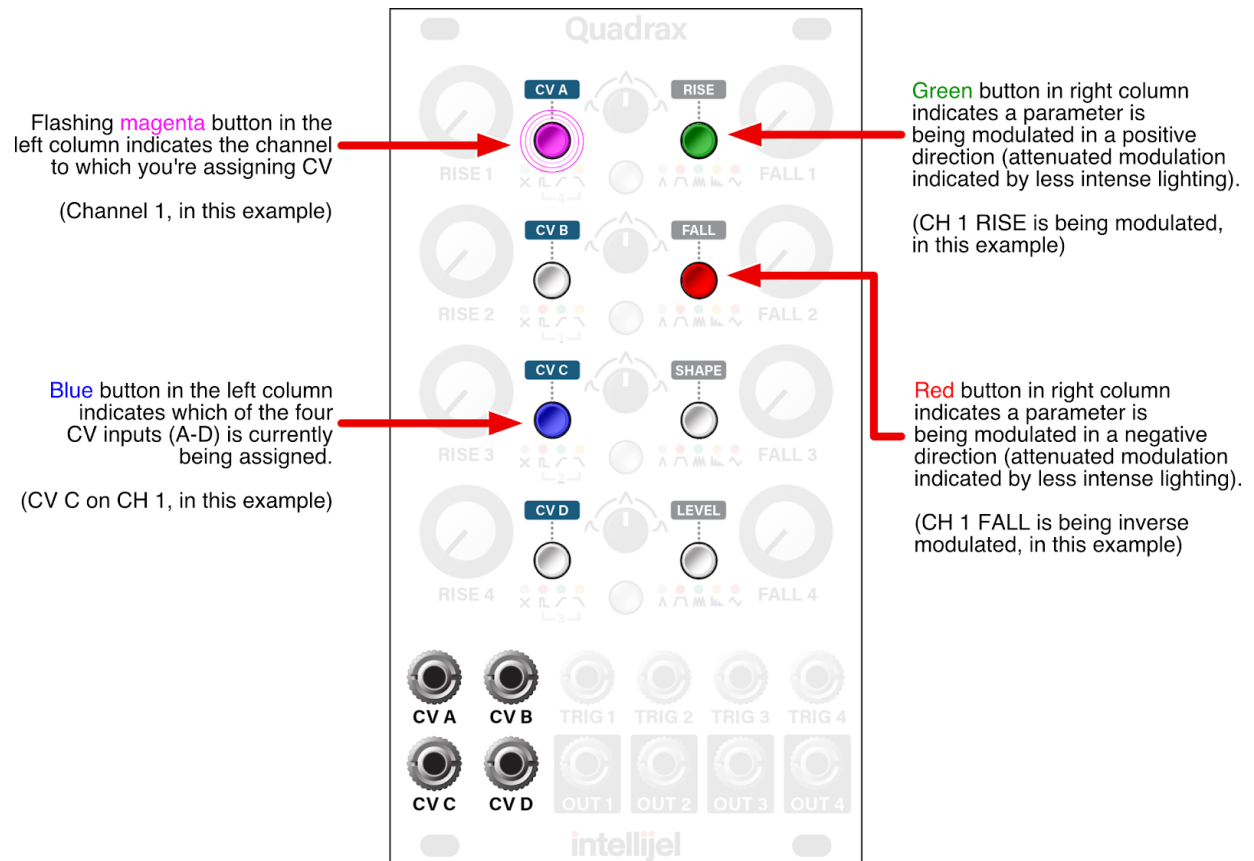

9. When you're done making CV assignments for all channels, long-press the LINK/CV button that's currently flashing **magenta**.

Quadrax returns to standard operating mode.

Clearing CV Assignments

You can clear individual CV assignments (as discussed, above, in [Programming the CV Matrix](#)); all CV assignments for a single channel; or all CV assignments for all channels. Specifically:

To clear all CV assignments on a single channel:

1. Make sure Quadrax is in CV Assignment mode (as discussed in [Enter/Exit CV Assignment Mode](#), earlier in this manual).
2. For the channel whose CV assignments you wish to clear, long-press (>1 second) the channel's LINK/CV and MODE/DESTINATION buttons simultaneously.

The channel's LINK/CV button will flash blue along with all four DESTINATION buttons, and all CV assignments will be cleared on that channel.

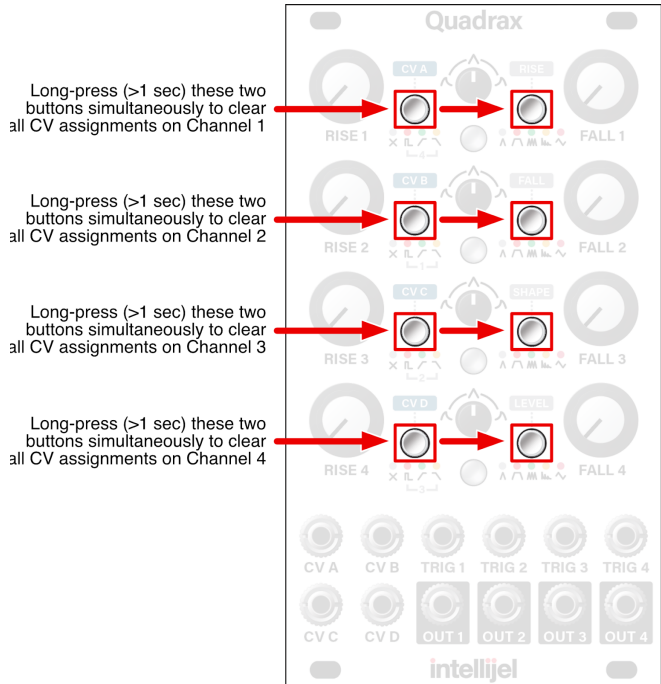

To clear all CV assignments on all channels:

1. Make sure Quadrax is in CV Assignment mode (as discussed in [Enter/Exit CV Assignment Mode](#), earlier in this manual).
2. Long-press (>1 second) the **CV A** (top left) and the **LEVEL** (bottom-right) buttons simultaneously.

All eight buttons will flash blue, indicating that all CV assignments have been cleared on all four channels.

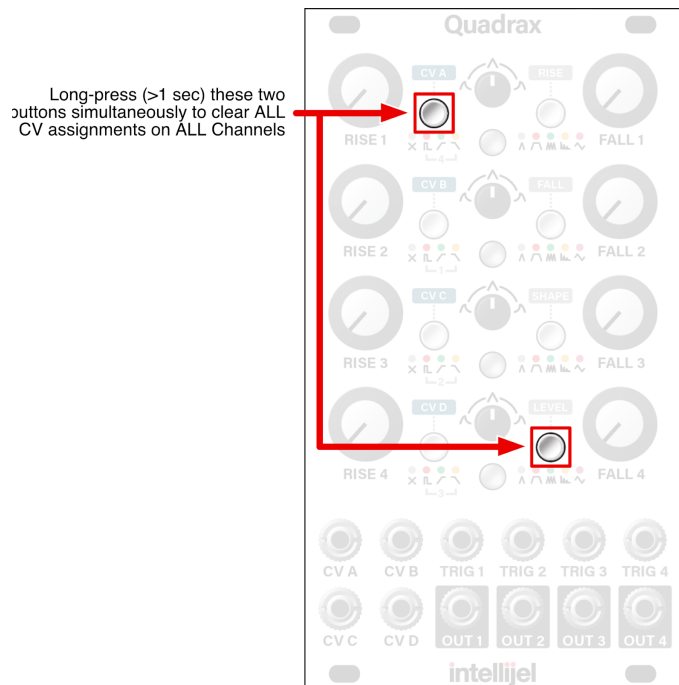

Using the Optional Qx Module

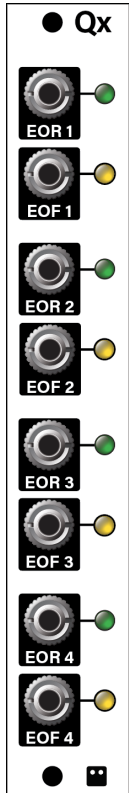

The Qx expander adds an EOR (**End Of Rise**) and an EOF (**End Of Fall**) output to each of Quadrax’s four channels, enabling Quadrax’s envelopes, cycles, bursts and LFOs to trigger external modules.

The definition of EOR and EOF varies depending on which mode is assigned to the corresponding Quadrax channel.

The following sections discuss exactly what triggers the Qx module’s EOR and EOF outputs for each of Quadrax’s five modes.

EOR/EOF for AD Mode

If a channel is set to AD mode, then the EOR and EOF outputs perform as follows:

- **EOR**: End of Rise: Goes high (+5V) when the Attack portion of the envelope reaches its maximum value, and stays high until the envelope completes its decay phase.
- **EOF**: End of Fall: Goes low (0V) when the Attack portion of the envelope reaches its maximum value, and stays low until the envelope completes its decay cycle, at which point the EOF goes high (+5V).

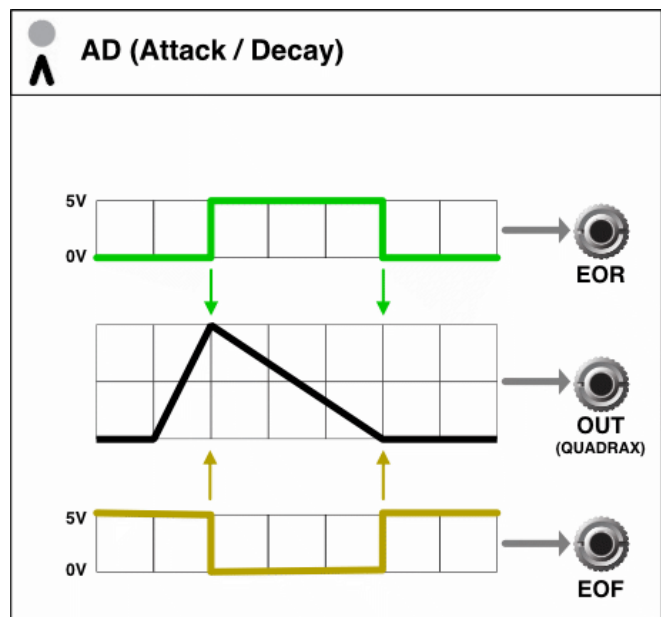

EOR/EOF for AHR Mode

If a channel is set to AHR mode, then the EOR and EOF outputs perform as follows:

- **EOR:** End of Rise: Goes high (+5V) when the Attack portion of the envelope reaches its maximum value, and stays high until the end of the release phase.
- **EOF:** End of Fall: Goes low (0V) at the start of the Release phase of the envelope (immediately after completing the Hold phase), and stays low until the envelope completes its release cycle, at which point the EOF goes high (+5V).

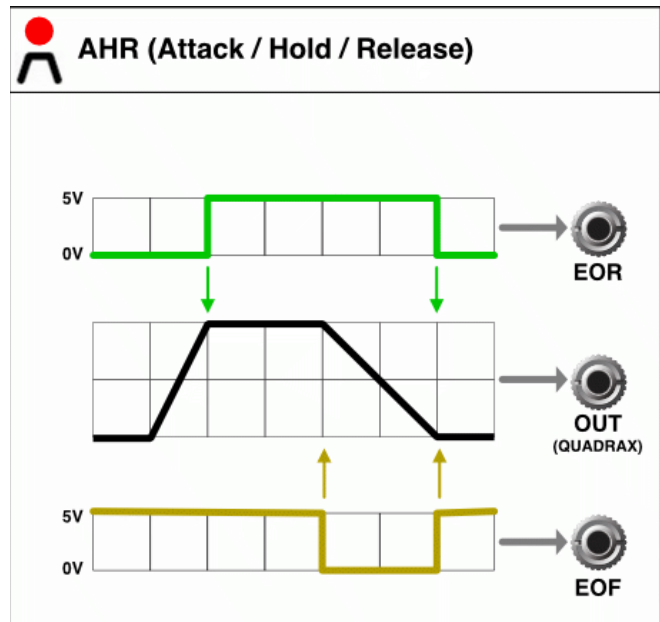

EOR/EOF for CYCLE Mode

If a channel is set to CYCLE mode, then the EOR and EOF outputs perform as follows:

- **EOR:** End of Rise: Goes high (+5V) when the Attack half of the cycle reaches its maximum value, and stays high until the cycle completes its decay phase, at which point the EOR goes low (0V).
- **EOF:** End of Fall: Goes low (0V) when the Attack half of the cycle reaches its maximum value, and stays low until the cycle completes its decay phase, at which point the EOF goes high (+5V).

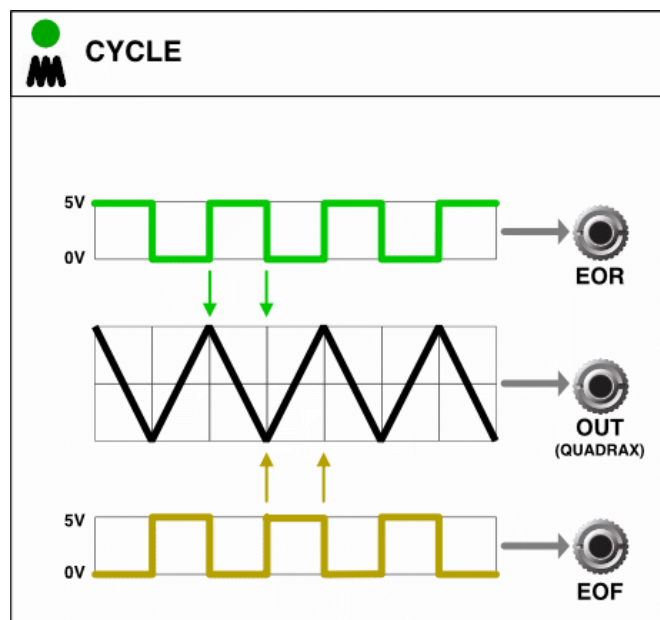

EOR/EOF for BURST Mode

If a channel is set to BURST mode, then the EOR and EOF outputs perform as follows:

- EOR:** Goes high (+5V) at the beginning of each individual pulse within a burst, and stays high for as long as the pulse remains above 0V. So, if a single burst contains 8 pulses, the EOR will trigger 8 times. This lets you trigger events in time with each individual pulse. Quadrax's FALL knob sets the number of pulses in a burst.
- EOF:** Stays at 0V for the entire length of the pulse burst (set with the RISE knob on Quadrax), then goes high (+5V) at the end of the overall burst, where it stays until the next burst is triggered. This lets you trigger events in time with the start and/or stop of the burst length.

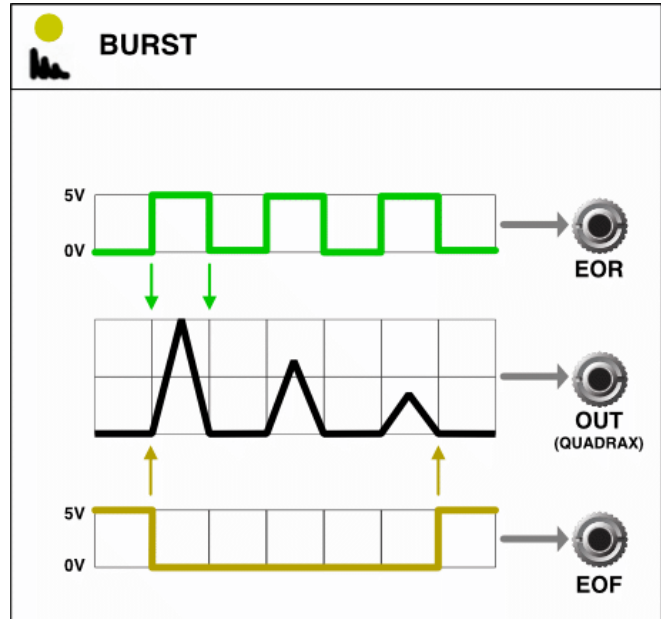

EOR/EOF for LFO Mode

If a channel is set to LFO mode, then the EOR and EOF outputs perform as follows:

- EOR:** The EOR output goes high (+5V) half-way through the cycle, and remains high until dropping to 0V when the cycle resets.
- EOF:** The EOF output is high (+5V) for the first half of an LFO cycle, and low (0V) for the second half.

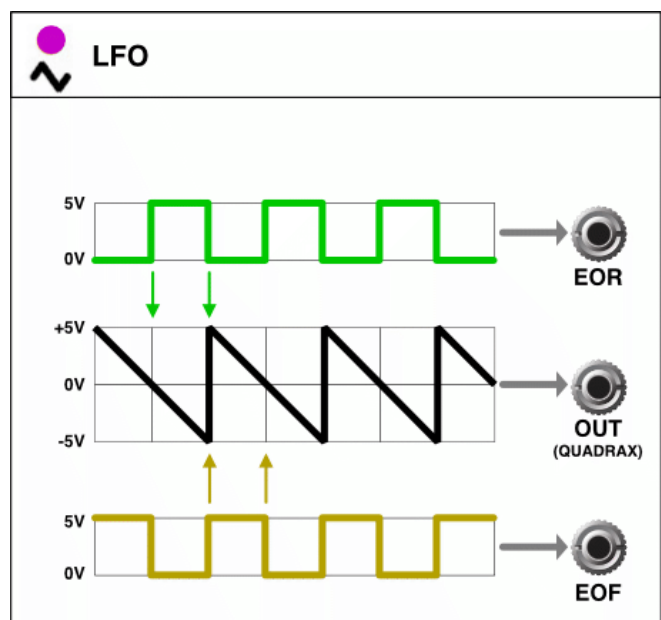

Firmware Version Display

Quadrax’s current firmware version is displayed for approximately 2 seconds when you power on the module. It displays the firmware version in binary format using the **1.x.y** format, with the left column displaying the **x** value and the right column displaying the **y** value.

In each column, the top LED is bit 0 and the bottom LED is bit 3.

For example, the illustration on the right indicates firmware version 1.5.2. The Major version (1.x.x) is implied, while the left column (0101) is a “5” and the right column (0010) is a “2”:

v1.	5.	2	
	1	0	(bit 0)
	0	1	(bit 1)
	1	0	(bit 2)
	0	0	(bit 3)

(NOTE: The color of the Firmware Version Display LEDs indicate whether Quadrax’s AD, AHR, CYCLE and BURST functions output 10V (blue) or 5V (green) signals, as discussed in [Inputs and Outputs](#).)

FIRMWARE INDICATOR (ON BOOT):

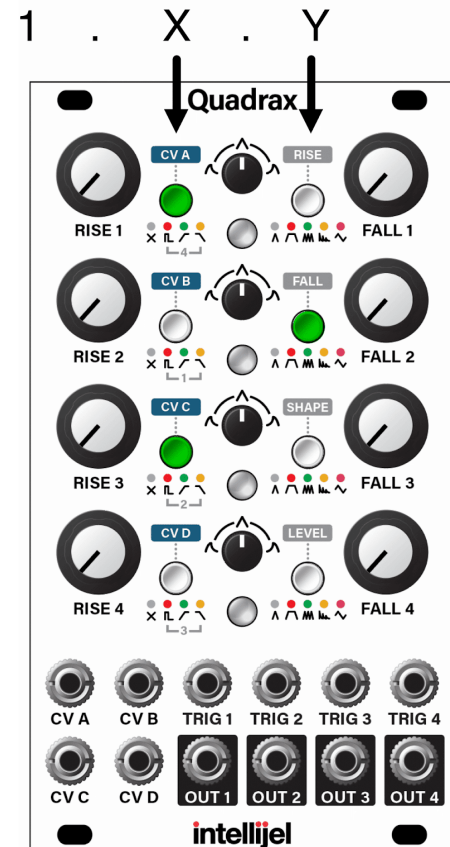

Firmware Change Log

1.0.1 (November, 2019)

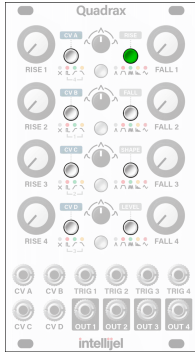

- Initial Release

Technical Specifications

QUADRAX	
Width	14 hp
Maximum Depth	38 mm
Current Draw	106 mA @ +12V 9 mA @ -12V

Qx EXPANDER	
Width	4 hp
Maximum Depth	22 mm
Current Draw	8 mA @ +12V 0 mA @ -12V