

minilogue xd

POLYPHONIC ANALOGUE SYNTHESIZER

minilogue xd module

POLYPHONIC ANALOGUE SYNTHESIZER

Owner's Manual

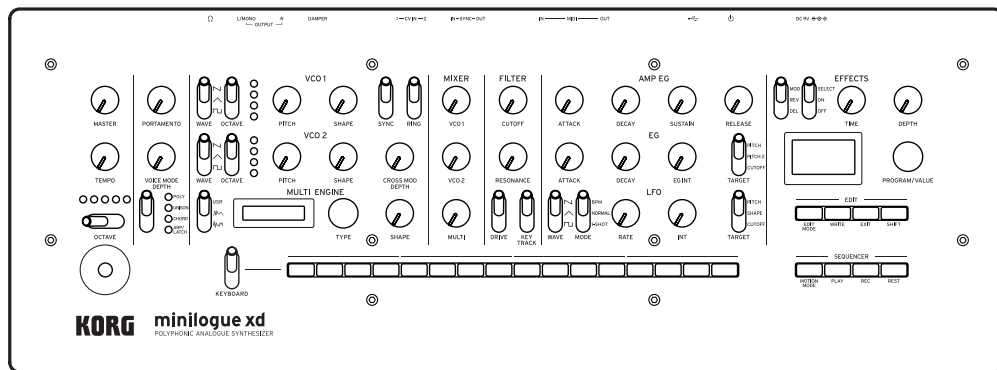
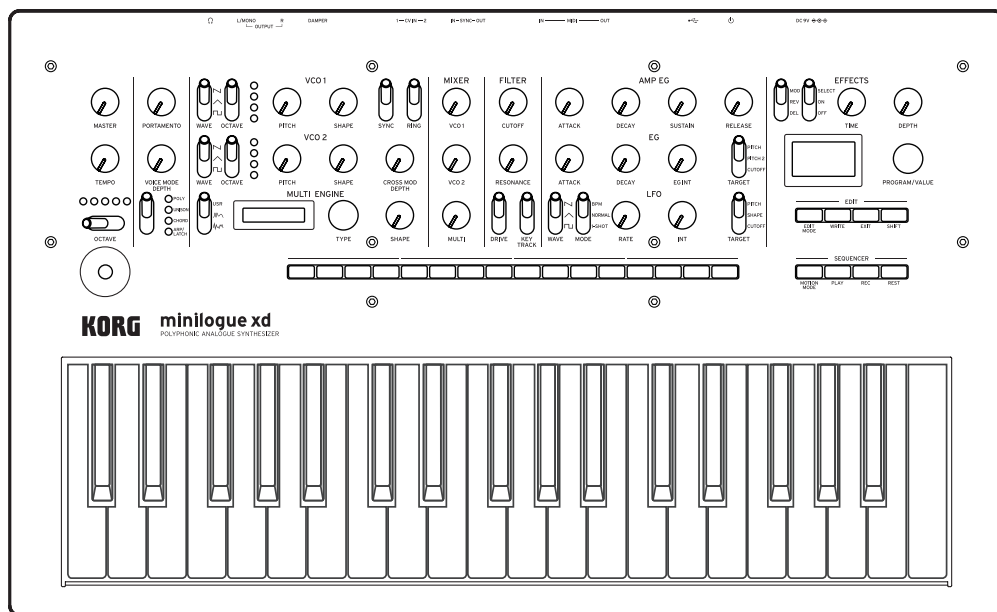

KORG

Contents

Introduction	3
About the owner's manual	3
Main features	3
Block diagram	4
Controls and connections	5
Front panel controls	5
Rear panel connections	7
Turning the power on/off	8
Playing the minilogue xd	10
Selecting and playing a program	10
Playing in Keyboard mode	11
Using Favorites	12
Playing the sequencer	13
Programs	14
Program architecture	14
Creating sounds	15
Saving a program	16
Basic parameters	17
MASTER controls	17
VCO 1/VCO 2/MULTI ENGINE section	18
MIXER section	22
FILTER section	23
EG/LFO section	24
EFFECTS section	26
Sequencer	27
Edit mode	33
How to enter the Edit mode	33
Edit mode parameter list	34
PROGRAM EDIT mode	35
SEQ EDIT mode	40
GLOBAL EDIT mode	42
Other functions	48
Tuning	48
Poly-chain	49
Restoring the factory settings	50
Shortcuts using the SHIFT button	50
Using with other devices	52
Making connections with the SYNC IN/OUT jacks	52
Making connections with the CV IN jacks	53
Connecting to a MIDI device or a computer	53
Data list	56
Effects list	56
Program list	58
Specifications	63
MIDI Implementation Chart	64

Introduction

About the owner's manual

The documentation for this product consists of the following:

- Precautions (included)
- Quick Start Guide (included)
Read this manual first. This guide explains the basic operations and other features of the minilogue xd.
- Owner's Manual (what you're reading)
This explains how to use the detailed functions of the minilogue xd

Conventions in this manual

This manual refers to both the minilogue xd and the minilogue xd module collectively as the "minilogue xd". When referring to a specific device, "**xd**" is used to indicate the minilogue xd only, and "**xd-m**" is used to indicate the minilogue xd module only.

The minilogue xd panel diagram is used for the purpose of illustration, unless otherwise noted.

Symbols , Note, Tip

These symbols respectively indicate a caution, a supplementary note, or a tip.

Main features

- The minilogue xd features an analog signal path with four voices that takes after the Korg prologue analog synthesizer.
- Each voice includes a MULTI ENGINE providing a noise generator, a VPM oscillator, and the possibility to load user programmed oscillators. This instrument combines two VCOs, making it possible to create a wide variety of sounds.
- The FX section is equipped with high quality digital effects (MODULATION, REVERB, DELAY).
- 500 programs (200 preset programs and 300 user programs as the factory-set default) can be called up and saved in an instant.
- The minilogue xd has a powerful 16-step polyphonic sequencer.
- Real-time oscilloscope provides visual feedback of parameter changes.
- Sync In and Sync Out jacks allow you sync analog tempo to and from other devices.
- Two CV IN jacks are available, letting you control the parameters of this instrument using a modular synthesizer or other device.
- **xd-m** In Keyboard mode, you can play or input sequence data using buttons 1–16.

Block diagram

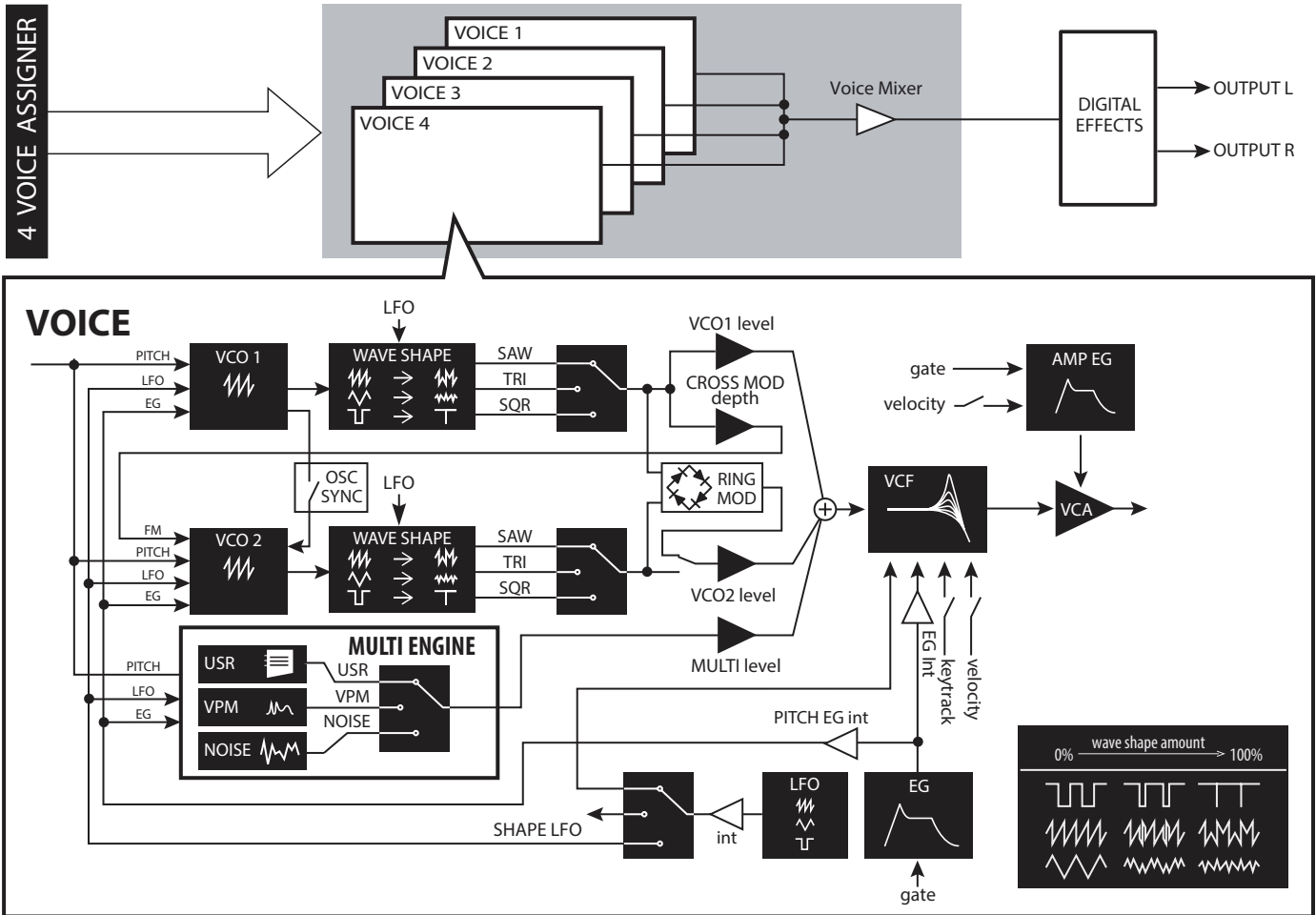

Controls and connections

Front panel controls

This diagram shows the layout of the front panel knobs, switches, and buttons.

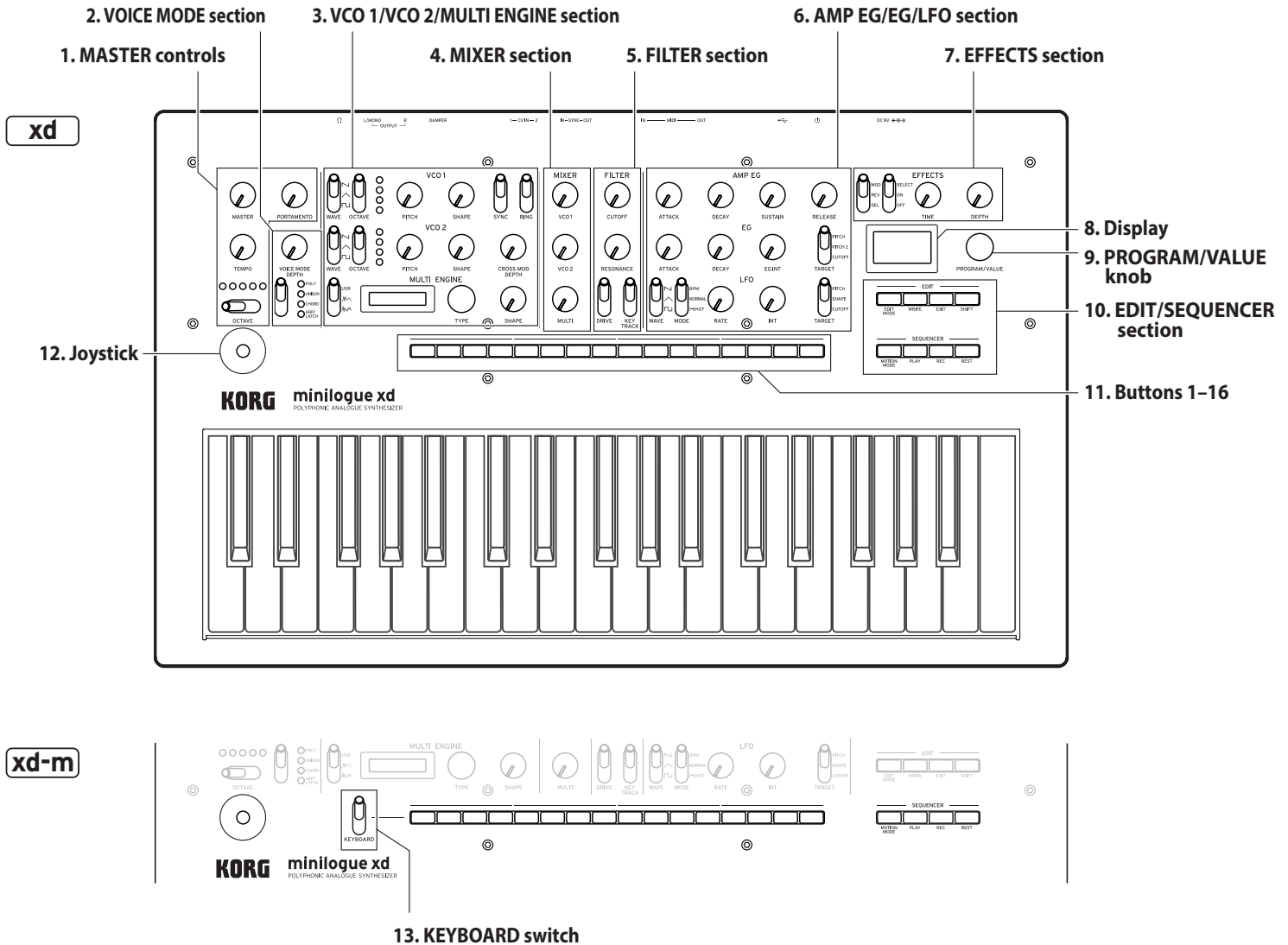

1. MASTER controls

- MASTER knob
- OCTAVE switch (p.10)
- TEMPO knob (p.17)
- PORTAMENTO knob (p.17)

2. VOICE MODE section (p.17)

- VOICE MODE DEPTH knob
- VOICE MODE TYPE switch

3. VCO 1/VCO 2/MULTI ENGINE section

- VCO 1 (p.18)
- WAVE switch
- OCTAVE switch
- PITCH knob
- SHAPE knob

VCO 2 (p.18)

- WAVE switch
- OCTAVE switch
- PITCH knob
- SHAPE knob
- SYNC switch
- RING switch
- CROSS MOD DEPTH knob
- MULTI ENGINE (p.19)
- NOISE/VPM/USR switch
- Display
- TYPE knob
- SHAPE knob

- 4. MIXER section (p.22)**
 - VCO 1 knob
 - VCO 2 knob
 - MULTI knob
- 5. FILTER section (p.23)**
 - VCF
 - CUTOFF knob
 - RESONANCE knob
 - DRIVE switch
 - KEYTRACK switch
- 6. AMP EG/EG/LFO section**
 - AMP EG (p.24)**
 - ATTACK knob
 - DECAY knob
 - SUSTAIN knob
 - RELEASE knob
 - EG (p.24)**
 - ATTACK knob
 - DECAY knob
 - EG INT knob
 - TARGET switch
 - LFO (p.25)**
 - WAVE switch
 - MODE switch
 - RATE knob
 - INT knob
 - TARGET switch
- 7. EFFECTS section (p.26)**
 - DEL/REV/MOD switch
 - OFF/ON/SELECT switch
 - TIME knob
 - DEPTH knob
- 8. Display (p.10) (p.46)**
- 9. PROGRAM/VALUE knob (p.10) (p.33)**
- 10. EDIT/SEQUENCER section**
 - EDIT (p.33)**
 - EDIT MODE button
 - WRITE button
 - EXIT button
 - SHIFT button
 - SEQUENCER (p.27)**
 - MOTION MODE button
 - PLAY button
 - REC button
 - REST button
- 11. Buttons 1–16 (p.11) (p.12) (p.13)**
 - (p.27) (p.31) (p.33)
- 12. Joystick (p.10)**
- 13. xd-m KEYBOARD switch (p.10)**

Rear panel connections

The illustration below shows a typical example of connections for the minilogue xd. Connect the minilogue xd as appropriate for your own sound system.

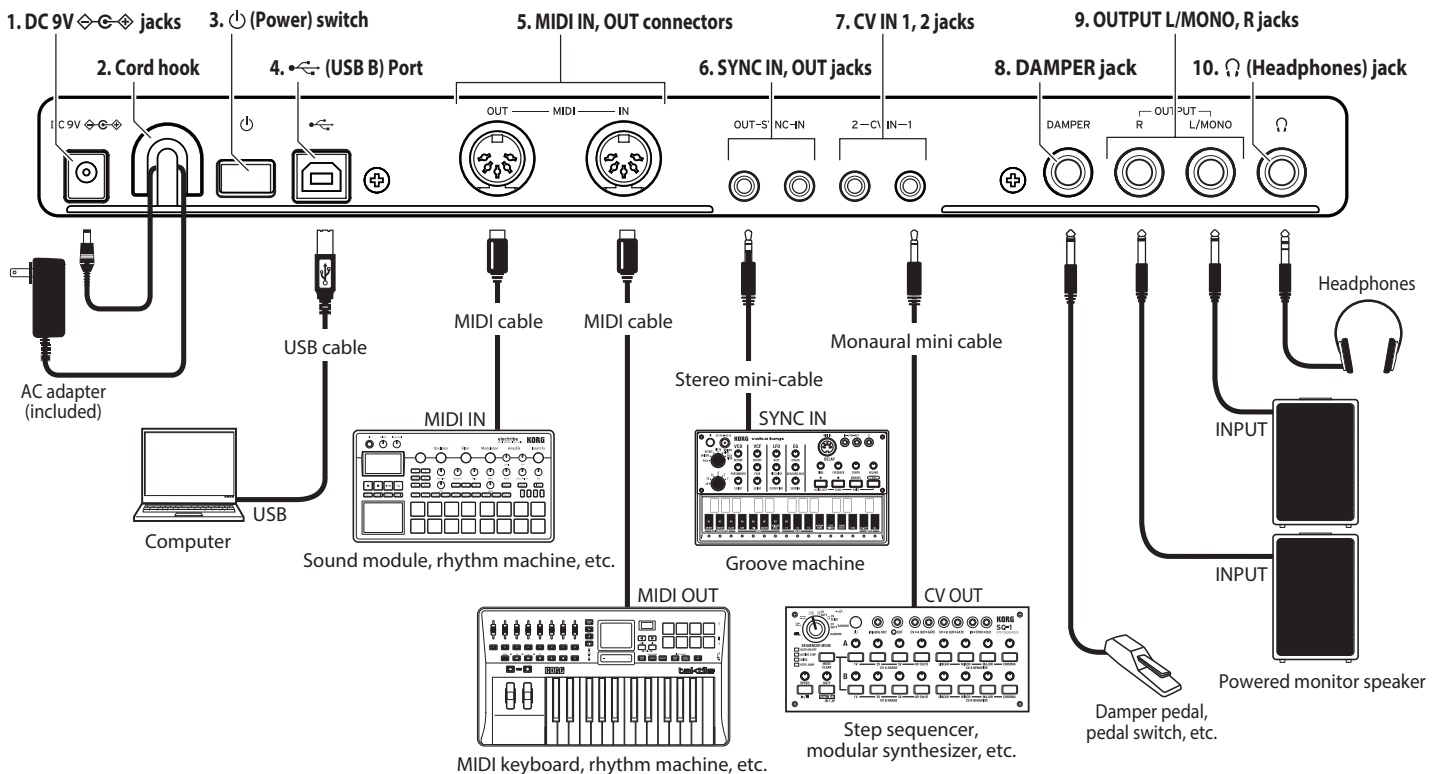

1. DC 9V jack (p.8)

Connect the DC plug of the included AC adapter to this jack.

2. **xd** Cable hook (p.8)

Loop the DC plug end of the AC adapter cable around this hook to prevent the cable from being accidentally pulled out.

3. Power switch (p.8)

Use this switch to turn the minilogue xd on or off.

4. USB B port (p.54)

This port allows the minilogue xd to exchange MIDI messages with your computer.

5. MIDI IN, OUT connectors (p.53)

Connect these to an external MIDI device so that MIDI data can be transmitted and received.

6. SYNC IN, OUT jacks (p.52)

Connect these jacks to the SYNC IN, OUT jacks on the Korg volca series, to synchronize with the pulses and steps that are outputted. The SYNC OUT jack outputs a 5 V pulse, 15 ms long at the beginning of each step. Use a stereo mini cable for this connection.

7. CV IN 1, 2 jacks (p.53)

Connect these jacks to a device that can output CV signals to control the parameters of the minilogue xd. The voltage range is from -5 V to $+5\text{ V}$. Use a monaural mini cable (or a stereo mini cable).

8. DAMPER jack

Connect a Korg DS-1H damper pedal (sold separately) or a PS-1/PS-3 pedal switch (sold separately) to control the damper function.

⚠ The minilogue xd does not feature a half-damper function.

9. OUTPUT L/MONO, R jacks (p.8)

Connect these jacks to a powered monitor speaker or similar device. Adjust the volume level using the MASTER knob. To output monaural sound, use the OUTPUT L/MONO jack.

10. Headphones jack (p.8)

Connect your headphones to this jack. This jack outputs the same signal as that of the OUTPUT jack.

Connecting the AC adapter

1. **Connect the DC plug of the included AC adapter to the DC 9V jack located on the rear panel of the minilogue xd.**
 - ⚠ Be sure to use only the included AC adapter. Using any other AC adapter may cause malfunctions.
 -  **Hook the AC adapter cord onto the cord hook.**
 - ⚠ Do not use excessive force when pulling the cord off the hook. Doing so may damage the plug.
2. **Connect the plug of the AC adapter to an AC outlet.**
 - ⚠ Be sure to use an AC outlet of the correct voltage for your AC adapter.

Connecting audio devices

- ⚠ Be sure that all of your devices are turned off when making connections. Making connections with the power still turned on may damage the device or speaker.
- **Connect the OUTPUT L/MONO, R jacks on the minilogue xd to your powered monitor speaker, mixer or other audio device.**
 - To output monaural sound, use the OUTPUT L/MONO jack.
- **To use headphones, connect the plug on your headphones to the headphones jack.**
 - Tip:** Adjust the volume levels for the OUTPUT jacks and headphones jack using the MASTER knob.

Connecting the minilogue xd to a computer or other MIDI devices

You can connect the minilogue xd to a computer or other MIDI device via USB or MIDI to send and receive note data. Refer to “Using with other devices” (p.52) for details.

You can also poly-chain this instrument to another minilogue xd. Refer to “Poly Chain” (p.45) and “Poly-chain” (p.49) for details.

Turning the power on/off

Turning the minilogue xd on

Make sure that both the minilogue xd and any external output devices such as powered monitor speakers are turned off, and turn the volume of all devices all the way down.

1. **Hold down the Power switch on the rear panel of the minilogue xd; once the “minilogue xd” logo appears in the display, take your finger off the Power switch.**
 - The word “Tuning...” will appear on the display, and the instrument will enter Tuning mode for the analog synthesizer circuit, for around 15 seconds. After this, the minilogue xd will enter to Play mode.
2. **Turn on any external output devices such as powered monitor speakers.**
3. **Adjust the volume of your external output equipment, and adjust the minilogue xd’s volume using the MASTER knob.**

Turning the minilogue xd off

Any program data in the minilogue xd that has not been saved will be lost when the power is turned off. Be sure to save any programs and other important data that you have edited (p.16 “Saving a program”).

1. Lower the volume of your powered monitors or external output system, and turn them off.
2. Hold down the Power switch on the rear panel of the minilogue xd; to turn off the power after the display goes blank, take your finger off the power switch.
 - ⚡ After turning the minilogue xd off, wait about 10 seconds before turning it on again.

Auto power off feature

The minilogue xd features an auto power off feature that can automatically turn the minilogue xd off after 4 hours have elapsed with no operation of the knobs, switches, buttons, or keyboard. By default, the factory setting for **auto power off is enabled**. The auto power off can be disabled using the steps below.

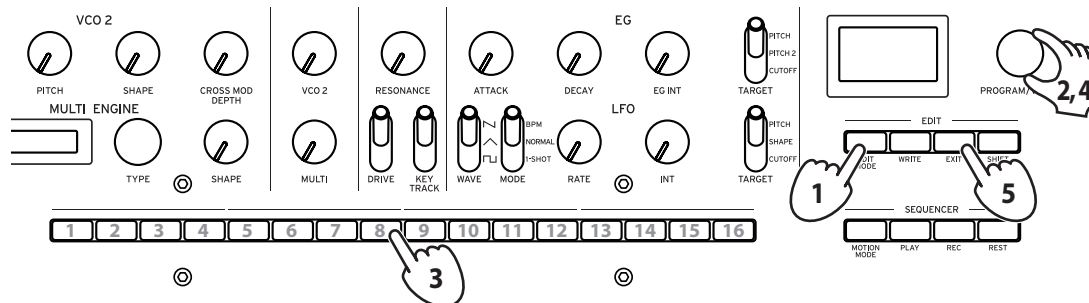

1. Press the **EDIT MODE** button.

The minilogue xd will enter Edit mode, and the display will look like the illustration shown below.



2. Turn the **PROGRAM/VALUE** knob, and select “GLOBAL EDIT.”

The minilogue xd will enter GLOBAL Edit mode.

Tip: GLOBAL EDIT can also be selected by pressing the EDIT MODE button.

3. Press **button 8** three times.

“Auto Power Off” will be displayed.

4. Turn the **PROGRAM/VALUE** knob, and select “Off”.

5. Press the **EXIT** button.

The minilogue xd will enter Play mode, and the display will indicate the current program.

Playing the minilogue xd

Selecting and playing a program

The minilogue xd features 500 program memories. When the unit is shipped from the factory, preset programs are assigned to program numbers 1–200. Programs 201–500 contain init programs (programs that have been initialized).

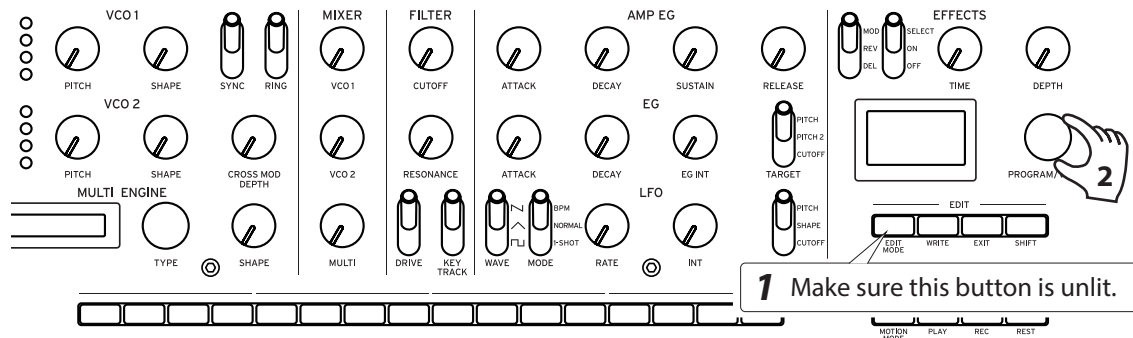

1. Check that the minilogue xd is in Play mode.

In Play mode, verify that the EDIT MODE button on the front panel is unlit. If the EDIT MODE button is lit, press the EXIT button.

2. Turn the PROGRAM/VALUE knob to select a program.

The display will indicate the program name. For details, refer to “Program list” (p.58).



Tip: In addition to showing the program name, the display can also be used as an **oscilloscope** to show the waveform created by the electrical signals of the sound.

3. Play the keyboard and try using the joystick and OCTAVE switch and other controls on the front panel.

You can use the **OCTAVE** switch to transpose the playing area of the keyboard by ± 2 octaves.

The **joystick** mainly controls the pitch when moved from left to right, and changes parameters such as the cutoff frequency and vibrato depth when moved up and down. You can also change which parameters are controlled by the joystick. See “Button 4 (JOYSTICK)” (p.35) for details.

Use the **VOICE MODE TYPE** switch to switch between voice modes. Select a voice mode and play. To learn more about voice modes, see “VOICE MODE section” (p.17).

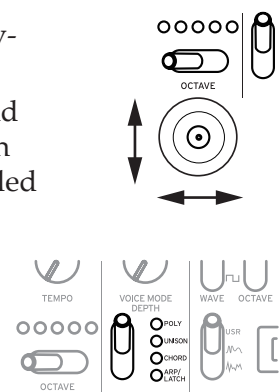

xd-m Playing in Keyboard mode

You can use the keyboard of an external device that is connected to the minilogue xd module via the MIDI IN connector or USB B port, or you can turn the Keyboard mode of the minilogue xd module on to play using buttons 1–16. Buttons 1–16 can be used for both step and real-time recording.

1. Flip the **KEYBOARD** switch up to turn Keyboard mode on.

A keyboard icon “” will be shown in the upper-right part of the display.

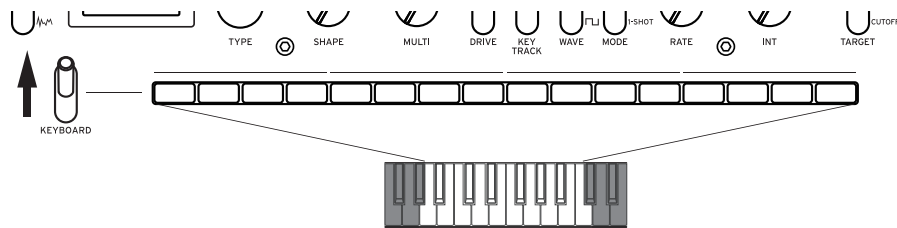

2. Play using buttons 1–16.

Buttons 1–16 will light to indicate the black and white keys.

3. After you've finished playing the buttons, flip the **KEYBOARD** switch down to turn Keyboard mode off.

Buttons 1–16

When the keyboard mode is set to OFF on the minilogue xd module, buttons 1–16 will operate as follows.

- Favorite programs: Recall, register
- Edit Mode: Select Edit page
- When the sequencer is playing: Step display
- Step recording: Change the step gate time, select step
- Step edit: Enable/disable step, input notes and motion sequences

Note: These operations are unavailable when the keyboard mode is ON. Use the **KEYBOARD** switch to switch between keyboard modes as necessary.

Using Favorites

You can use the **favorites** to register up to 16 programs that you like, to easily call them back later.

Recalling your favorite programs

1. In Play mode, press one of the buttons from 1–16 while holding down the SHIFT button. The favorite program previously registered to that button will be recalled, and the program name will be shown in the display.

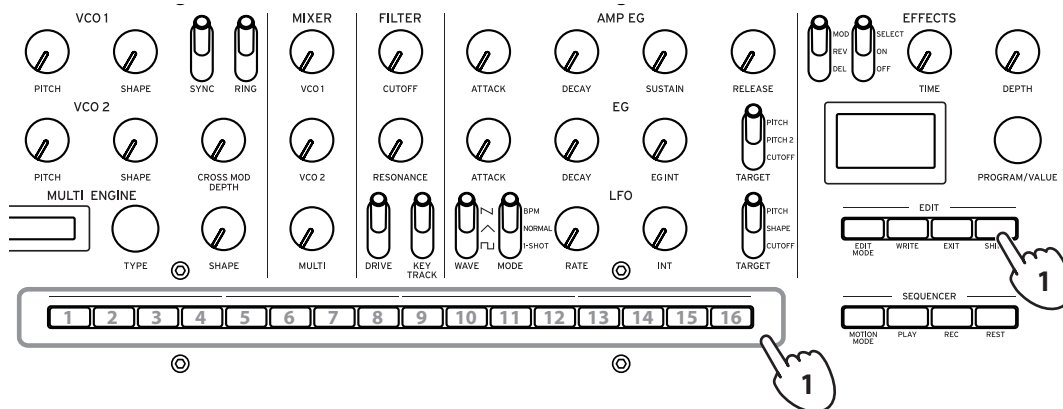

Registering your favorite programs

1. In Play mode, turn the PROGRAM/VALUE knob to select the program you like. The display will indicate the program name.

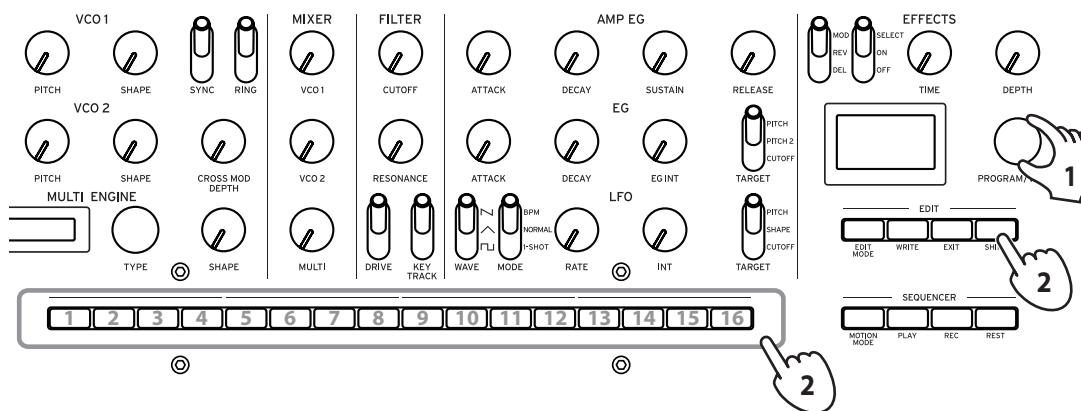

2. Hold down one of the buttons from 1–16 while keeping the SHIFT button pressed. The program will be registered as a favorite program, and “Registered to Favorite” will be shown in the display.

Tip: The favorite programs that you register will be saved in the global settings.

Playing the sequencer

Each program in the minilogue xd includes sequence data. In this section, we'll play the sequence data saved as part of the preset programs.

1. Turn the PROGRAM/VALUE knob to select a program.

The display will indicate the program name.

2. Press the PLAY button in the SEQUENCER section.

The sequence data that is recorded in the current program will begin playing. The 1–16 buttons will light up to show the current step while the sequencer is playing.

Tip: The sequencer tempo is set individually in each program. You can change the tempo in SEQ EDIT mode, “BPM” (p.40). You can also adjust the tempo from 56.0 to 240.0 BPM (beats per minute) by turning the TEMPO knob.

3. Press the PLAY button once more to end the Sequencer playback.

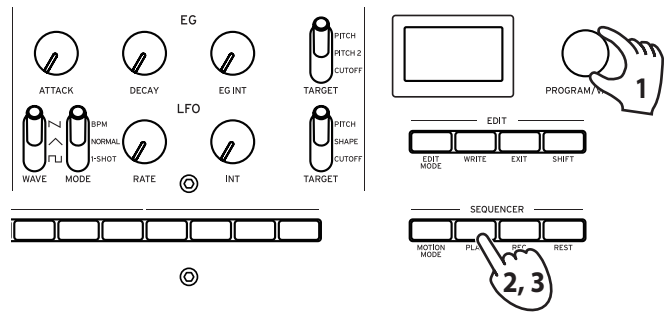

Programs

Program architecture

A program includes settings for sounds, voice mode and effects, as well as sequence data and so on. (MASTER knob and joystick settings are not included in programs.)

Try editing each related parameter, and enjoy the sounds of the minilogue xd.

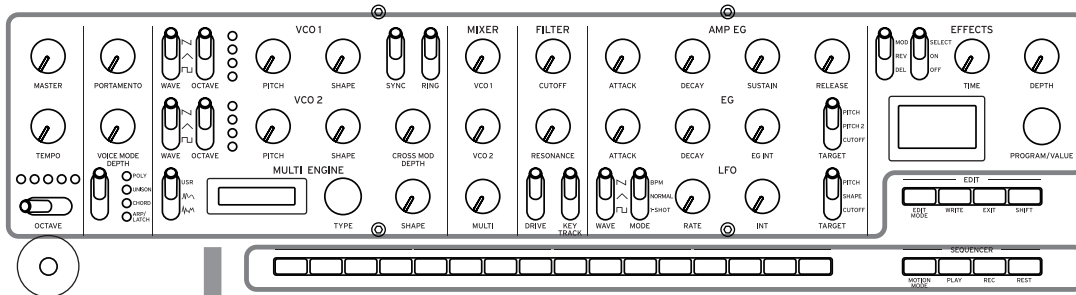

Basic Parameters

MASTER	Engine Parm Setting (SHIFT + SHAPE)	LFO
TEMPO		WAVE
OCTAVE		MODE
PORTAMENTO	MIXER	RATE
VOICE MODE DEPTH	VCO1 Level	INT
VOICE MODE Type	VCO2 Level	TARGET
VCO 1	VCF	MOD
WAVE	CUTOFF	Off/On
OCTAVE	RESONANCE	MOD FX Type
PITCH	DRIVE	Sub Type (SHIFT + TypeSELECT)
SHAPE	KEYTRACK	DELAY
VCO 2	AMP EG	Off/On
WAVE/OCTAVE	ATTACK	DELAY Sub Type
PITCH	DECAY	TIME
SHAPE	SUSTAIN	DEPTH
SYNC	RELEASE	Wet/Dry (SHIFT + DEPTH)
RING	EG	REVERB
CROSS MOD DEPTH	ATTACK	Off/On
MULTI ENGINE	DECAY	REVERB Sub Type
TYPE	EG INT	TIME
NOISE/VPM/USR	TARGET	DEPTH
SHAPE		Wet/Dry (SHIFT + DEPTH)

Detailed Parameters*

JOYSTICK	PITCH SETTING	OTHER SETTINGS
X+ Bend Range	Microtuning	Multi Octave
X- Bend Range	Scale Key	Multi Routing
Y+ Assign	Program Tuning	EG Legato
Y+ Range	Transpose	Portamento Mode
Y- Assign	LFO	Portamento BPM
Y- Range	LFO Target Osc	Program Level
CV INPUT	LFO Key Sync	MULTI ENGINE
CV IN Mode	LFO Voice Sync	Parameter 1-6
CV IN1 Assign	MODULATION	PROGRAM NAME
CV IN1 Range	EG Velocity	Program Name
CV IN2 Assign	Amp Velocity	
CV IN2 Range		

Sequence data

NOTE [STEP 1-16]
GATE TIME [STEP 1-16]

STEP	1	2	3	...	14	15	16
NOTE	♪	♪		...	♪	♪	♪
GATE	▬	▬		...	▬	▬	▬

Sequence parameters *

BPM (TEMPO)

Step Length
Step Resolution
Swing
Default Gate Time

Motion Type (1-4)
Motion Enable (1-4)
Motion Smooth (1-4)

* Edit mode parameters

Creating sounds

You can edit the parameters that make up a program, in order to modify the sound as you like. There are two ways to create sounds on the minilogue xd.

- You can select an existing program that's close to the sound you want, and edit that program's parameters to achieve your own custom sound.
- You can also create your own sound from scratch from an init program.

Editing an existing program

1. In Program mode, select the program that you want to use as a starting point.

2. Use the knobs and switches on the front panel.

Take a moment to consider the differences between the current program and the sound you have in mind, and use the front panel controls to edit the necessary parameters.

Tip: For details on how the pitch, sound, and volume change when using the knobs and switches, refer to "Basic parameters" (p.17).

 We recommend that you save the program on the minilogue xd after editing the sound. Any edits that you make will be lost if you turn off the power or recall a different program. See "Saving a program" (p.16) for details.

Creating a program from scratch

To create a program from scratch, we recommend that you use the **panel load** function. This will load the current settings of each front panel control and provide a simple starting point for your sonic creations.

As you explore the front panel controls, you can see how each parameter will affect the sound, making it easier to understand how each section of the minilogue xd functions and how the parameters interact.

You can also create programs after initializing them (p.40 "Initialize Program").

Panel load function

When the PLAY button is pressed while holding down the SHIFT button, the panel load function will be enabled. The sound will change to reflect the panel settings, and "Load Panel" will be indicated in the display.

Saving a program

We recommend that you save your program on the minilogue xd after editing the sound to your liking.

⚠ Any edits that you make will be lost if you turn off the power or recall a different program before saving the program.

1. **Edit the program in Play mode.**
See “Basic parameters” (p.17) for details.

2. **Press the WRITE button. The minilogue xd will enter write standby mode, and the WRITE button will blink.**

The display will indicate the message “Where to write?”.

3. **Turn the PROGRAM/VALUE knob to select the program number where your new sound will be saved.**

Tip: Press the EXIT button to cancel the operation.

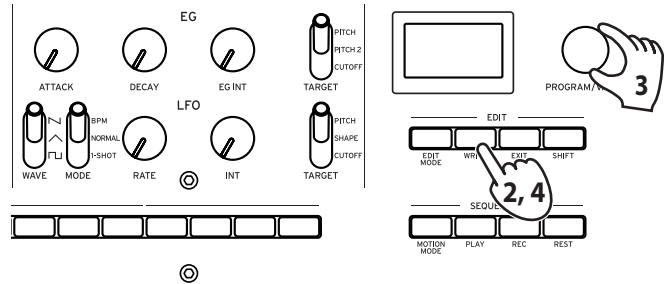

4. **Press the WRITE button once more.**
The display will indicate the message “Complete”.

⚠ Never turn off the power while programs are being saved. Doing so may destroy the internal data.

Basic parameters

In this section, we'll explain the basic parameters that make up a program.
The basic parameters are assigned to the knobs and switches on the front panel.

MASTER controls

To learn more about the OCTAVE button, see "Selecting and playing a program" (p.10).

TEMPO knob [BPM 56.0...240.0]

Use this parameter to adjust the tempo of the sequencer for each program in beats per minute (BPM). When the voice mode is "ARP", the value set here is also used for the arpeggiator tempo.

PORTAMENTO knob [0...127]

This parameter controls the portamento time.

The further the knob is turned to the right, the longer the portamento time will be.

VOICE MODE section

The minilogue xd features four analog synthesizer voices. By changing the Voice mode, you can combine and allocate the voices in different ways.

There are four voice modes. Use the VOICE MODE TYPE switch to select a voice mode.

Turning the VOICE MODE DEPTH knob adds different effects for each Voice mode.

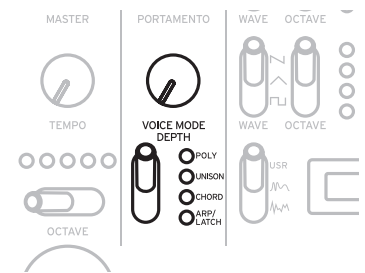

Voice mode list

Type	Action	VOICE MODE DEPTH knob effect
POLY	Used for basic playing as a 4-voice polyphonic synth.	[POLY, DUO 0...1023] Turn the knob to the right to switch to DUO mode, which stacks two voices when playing a key. Turning the knob to the right will increase the sound of the stacked voice, and deepen the detune effect.
UNISON	The 4 voices will be stacked together into a single voice in unison, as a mono synth.	[Detune 0C...50C] Turning the knob to the right will increase the detuning effect.
CHORD	The voices will play as a chord.	[Mono, 5th, sus2, m, Maj, sus4, m7, 7, 7sus4, Maj7, aug, dim, m7b5, mMaj7, Maj7b5] Selects either mono or the chord type.

Type	Action	VOICE MODE DEPTH knob effect
ARP/LATCH	Uses the arpeggiator to play up to 4 voices. Switches between LATCH ON and OFF. Set the arpeggiator tempo, swing and gate time using the "TEMPO knob" (p.17), "Swing" (p.40) and "Default Gate Time" (p.40) settings.	[MANUAL 1, MANUAL 2, RISE 1, RISE 2, FALL 1, FALL 2, RISE FALL 1, RISE FALL 2, POLY 1, POLY 2, RANDOM 1, RANDOM 2, RANDOM 3] Selects the arpeggiator type. If you set the VOICE MODE TYPE switch to ARP/LATCH and then move the switch down, the latch will be turned on (the LED will blink), and the arpeggiator will keep playing even after you take your hands off the keyboard. If you move the switch up while latched, the switch will latch off (the LED will light).

VCO 1/VCO 2/MULTI ENGINE section

VCO 1, VCO 2 VCO: Voltage Controlled Oscillator

There are two oscillators in the minilogue xd. Here, we will adjust the basic settings for the sound, including pitch (OCTAVE, PITCH), waveform (WAVE, SHAPE) and so on.

WAVE switch [SQR □, TRI ▲, SAW ▼]

This sets the waveforms for oscillators 1 and 2.

SQR (square wave): This waveform is used for electronic and wind instrument sounds.

TRI (triangle wave): This waveform has a rounder feel than the sawtooth or square wave.

SAW (sawtooth wave): This waveform is used to create sounds typical of analog synthesizers, such as synth basses and synth brass.

OCTAVE switch [16', 8', 4', 2']

The pitch of oscillators 1 and 2 can be set in octave steps.

PITCH knob [-1200...+1200]

The pitch, or tuning, of oscillators 1 and 2 can be set in one-cent steps.

SHAPE knob [0...1023]

This knob will determine the final shape, complexity, or duty-cycle (square) of the selected waveform for oscillators 1 and 2.

0 —————> 1023

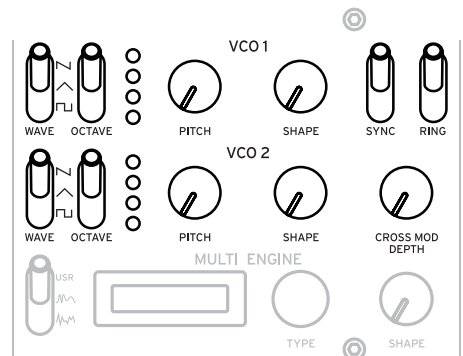
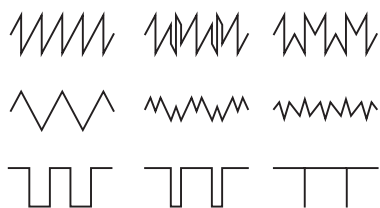

SYNC switch [OFF/ON]

This switch lets you sync the oscillators.

Oscillator sync is a popular effect for creating edgy synth leads.

ON (up position): With this type of modulation, the phase of oscillator 2 is forcibly synchronized to the phase of oscillator 1. This adds harmonic overtones to the frequency of oscillator 2, making a complex waveform.

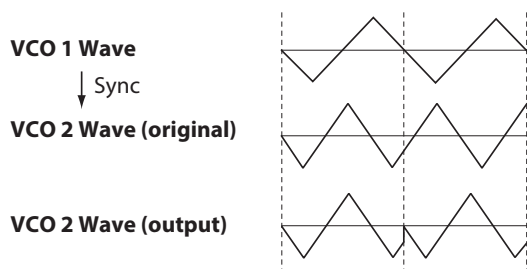

RING switch [OFF/ON]

This lets you achieve a ring modulation effect.

Adjust the pitch of oscillator 2 to create non-tonal and metallic sounds.

ON (up position): Oscillator 1 is used to ring modulate oscillator 2.

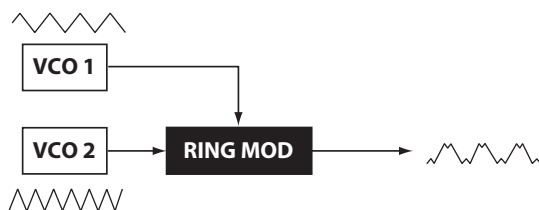

CROSS MOD DEPTH knob [0...1023]

Cross Mod (Modulation) allows oscillator 1 to modulate the pitch of oscillator 2.

Turning the knob to the right results in stronger modulation.

MULTI ENGINE

The MULTI ENGINE is a digital sound generation engine.

This engine operates as a noise generator, a VPM oscillator or a user oscillator, to make a wide range of sounds not possible with analog oscillators. You can load your own oscillator programs into the user oscillator to make sounds.

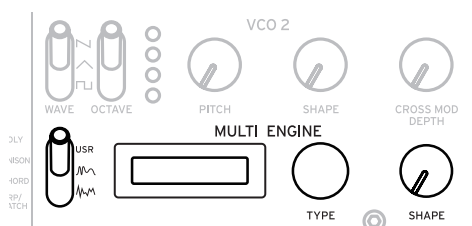

NOISE/VPM/USR switch [NOISE, VPM, USR]

This sets which engine will be used, the noise generator, VPM oscillator or user oscillator.

NOISE: The MULTI ENGINE is used as a noise generator.

VPM: The MULTI ENGINE is used as a VPM oscillator.

USR: The MULTI ENGINE is used as a user oscillator.

The TYPE knob and SHAPE knob work differently, depending on the NOISE/VPM/USER switch setting. The settings are explained below.

NOISE

Noise is used to create percussion instrument sounds, or sound effects such as surf. Select one of the four noise generators using the TYPE knob. Move the SHAPE knob to make changes in the sound.

TYPE knob [High/Low/Peak/Decim]

Select the noise generator to use. The noise generator name will be indicated on the MULTI ENGINE display.

High: A high-pass filter will be used.

Low: A low-pass filter will be used.

Peak: A peak filter (bandpass filter) will be used.

Decim: A decimator will be used.

SHAPE knob

Set the noise generator parameter to make changes to the sound. The parameters differ depending on the noise generator that you select using the TYPE knob, with the following effects.

SHAPE knob effects

Type	Parameter	Effect
High	CUTOFF (SHAPE knob)	[10.0Hz...21.0kHz] Adjusts the cutoff frequency of the HPF.
Low	CUTOFF (SHAPE knob)	[10.0Hz...21.0kHz] Adjusts the cutoff frequency of the LPF.
Peak	BANDWIDTH (SHAPE knob)	[110.0Hz...880.0Hz] Adjusts the peak characteristic bandwidth.
Decim	RATE (SHAPE knob)	[240Hz...48.0kHz] Adjusts the sample rate.
	KEY TRACK (SHIFT button+SHAPE knob)	[0.0%...100.0%] Adjusts the depth of the sample rate via keyboard tracking.

VPM

This engine is a VPM (Variable Phase Modulation) oscillator. The engine features a simple structure with one carrier and one modulator, but allows you to create a wide range of sounds. Sixteen oscillator types are available for this VPM oscillator.

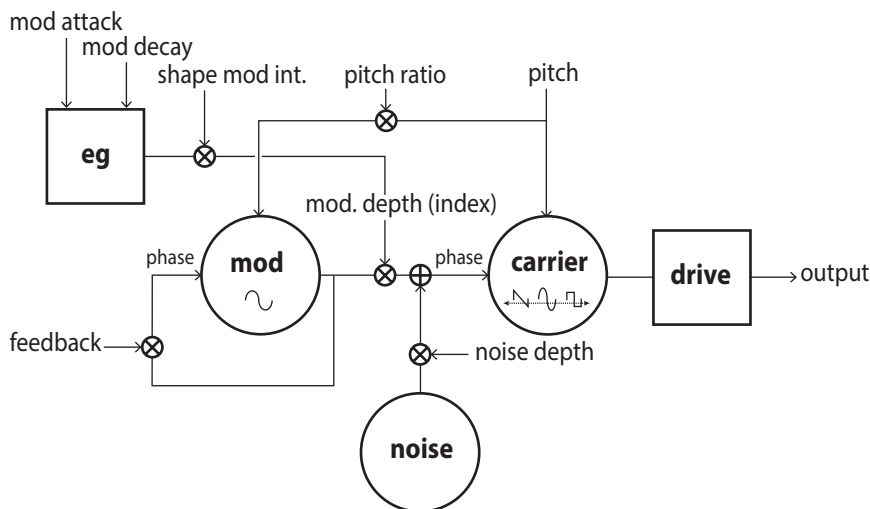

TYPE knob

[Sin1...Throat]

This selects the oscillator type to use.

The name of the oscillator type will be indicated on the MULTI ENGINE display.

Tip: For the last four types after Decay1, setting Shape Mod Int to “-100%” will disable completely the effect of the EG.

Sin1: A basic oscillator type, using a sine wave for both the carrier and modulator.

Sin2: Sine wave carrier and a modulator with self-feedback.

Sin3: Sine wave carrier with a 3x harmonics modulator.

Sin4: Sine wave carrier with 5x harmonics modulator.

Saw1: Modulated sawtooth carrier basic type.

Saw2: Carrier using a sine wave to simulate a sawtooth.

Squ1: Square wave carrier type.

Squ2: Carrier using a sine wave to simulate a square wave.

Fat1: 1/4 subharmonic modulator with self-feedback and driven carrier output, emphasizing the lower harmonics.

Fat2: 3/4 subharmonic modulator with self-feedback and driven carrier output, emphasizing the lower harmonics.

Air1: Noise-modulated sine wave carrier.

Air2: Sine wave carrier modulated by both noise and a sine wave.

Decay1: Type with decaying modulation amount.

Tip: You can edit the relative offsets of the internal EG decay time of the VPM (see block diagram) by using the parameters in PROGRAM EDIT mode “Button 10 (MULTI ENGINE)” (p.39).

Decay2: Type with strong decaying modulation amount.

Creep, Throat: Experimental, somewhat atonal type with complex and evolving modulations.

SHAPE knob

Turning the SHAPE knob only will set the “MOD DEPTH,” and turning the SHAPE knob while holding down the SHIFT button will set the “RATIO OFFSET.”

These parameters are common for all oscillator types, and produce the following effects.

SHAPE knob effects

Type	Parameter	Effect
Common	MOD DEPTH (SHAPE knob)	[0.00:15.00...] (range changes depending on TYPE) This adjust the index and sets the intensity of the modulator.
	RATIO OFFSET (SHIFT button+SHAPE knob)	[1:4, 1:2, 1:1, 2:1...] (range changes depending on TYPE) This adjusts the modulator ratio and adds over-tones.

Tip: Besides the SHAPE knob, the oscillator settings can be changed in detail with six parameters in PROGRAM EDIT mode. See “When the VPM oscillator is selected” (p.39) for details.

USR

You can load your own oscillator programs into a user oscillator to make sounds on the minilogue xd.

Up to 16 user oscillators can be saved. One factory-set default user oscillator is included with the minilogue xd for demo purposes.

See the “logue SDK” (www.korg.com) for details.

TYPE knob

Selects a user oscillator.

The name of the user oscillator will be indicated on the MULTI ENGINE display.

SHAPE knob [0.0%... 100.0%]

Produces the effect that is set for the user oscillator.

MIXER section

Use this section to set the output levels of oscillator 1, 2 and the MULTI ENGINE, and to adjust the balance.

VCO 1 knob [0...1023]

VCO 2 knob [0...1023]

MULTI knob [0...1023]

These knobs control the output levels.



FILTER section

VCF VCF: Voltage Controlled Filter

The low-pass filter creates a brighter or darker sound by selectively filtering certain parts of the harmonic spectrum of the sound generated by the oscillators and the noise generator.

CUTOFF knob [0...1023]

This knob is used to set the cutoff frequency (the frequency at which the filter is applied).

Turning the knob to the left will lower the cutoff frequency, and turning the knob to the right will raise the cutoff frequency.

- ⚠ If the CUTOFF value is set too low, the volume may be extremely low.

RESONANCE knob [0...1023]

Also known as Peak or Q, the RESONANCE control adds additional emphasis to the overtones occurring at the CUTOFF frequency, giving a distinctive character to the sound.

Turning the knob to the right will emphasize the harmonic content, increasing the resonance effect.

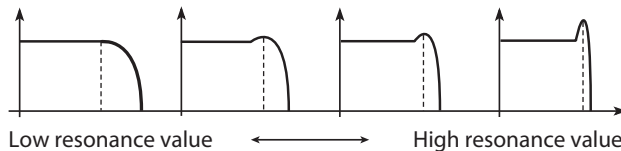

- Tip:** The overtones that are emphasized will change depending on the cutoff frequency. For this reason, it's good to adjust the CUTOFF knob while adjusting the RESONANCE knob.
- ⚠ When emphasizing the overtones in this way, the sound may distort depending on the cutoff frequency or the input audio.

DRIVE switch [0%, 50%, 100%]

Sets the distortion effect produced by the drive circuit, in three stages.

0% (switch in the lower position): no drive effect.

50% (switch in the center position): drive effect will be set at half strength.

100% (switch in the upper position): drive effect will be set at maximum.

KEYTRACK switch [0%, 50%, 100%]

Key tracking allows the note played on the keyboard to influence the cutoff frequency of the filter.

0% (lower position): No keyboard tracking will be applied.

50% (center position): Keyboard tracking will affect the cutoff frequency, but at only half the amount produced by 100%. For example, playing the C5 note on the keyboard will produce a harmonic that is an augmented fourth higher than the cutoff frequency of C4.

100% (upper position): The cutoff frequency will change at the same rate/slope as the pitch of the keyboard, centered on C4. For example, pressing the C5 key will give a cutoff frequency one octave higher than the C4 key.

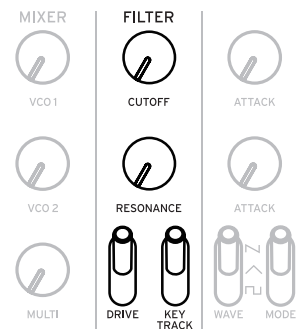

EG/LFO section

AMP EG

VCA: Voltage Controlled Amplifier / EG: Envelope Generator

These are the settings for the envelope generator (EG), which controls changes in the signal volume of the VCA over time.

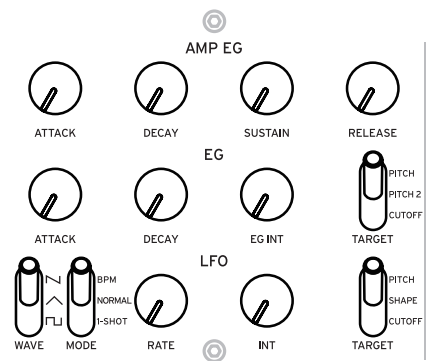
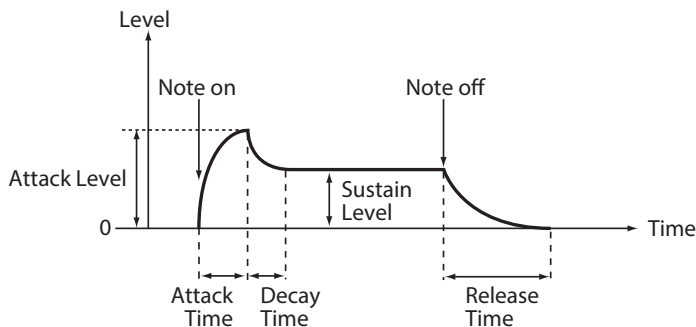

ATTACK knob [0...1023]

The ATTACK specifies the time required for the EG to reach its maximum level once a new note is played (note-on).

DECAY knob [0...1023]

The DECAY specifies the time required for the EG to fall to the preset sustain level once the attack portion of the EG is complete.

SUSTAIN knob [0...1023]

The SUSTAIN specifies the level that will be maintained after the decay time while the key is held down.

RELEASE knob [0...1023]

The RELEASE specifies the time required for the EG to reach its minimum level (zero) once the key or trigger is released (note off).

EG

EG: Envelope Generator

The envelope generator (EG) is used to change the pitch and cutoff frequency over time.

ATTACK knob [0...1023]

The ATTACK specifies the time required for the EG to reach its maximum level once a new note is played.

DECAY knob [0...1023]

The DECAY specifies the time required for the EG to fall to the preset sustain level once the attack portion of the EG is complete.

EG INT knob [-100%... 0%...+100%]

Adjusts the intensity of the EG.

Turning the knob to the right will increase the intensity.

When set to a negative value, the EG will be applied in the negative direction.

TARGET switch [PITCH, PITCH 2, CUTOFF]

This sets what the EG will be applied to.

PITCH: Applies the EG to the pitch of VCO 1, VCO 2 and the MULTI ENGINE.

PITCH 2: Applies the EG to the pitch of VCO 2.

CUTOFF: Applies the EG to the cutoff frequency of the FILTER.

LFO

LFO: Low Frequency Oscillator

The LFO is a low frequency oscillator that creates a repeating cyclical signal to modulate the pitch, sound and so on.

Depending on its target, the LFO can provide vibrato (PITCH); tonal changes to the Oscillators (SHAPE); or wah-wah (CUTOFF) effects.

WAVE switch [SQR □, TRI ^, SAW ∇]

The LFO can be set to a square wave (□), a triangle wave (^), or a sawtooth wave (∇).

MODE switch [1-SHOT, NORMAL, BPM]

Specifies the range of change and action for the LFO frequency.

1-SHOT: The LFO stops after a half-cycle from the time that the sound is played. The range of change for the LFO frequency will be from 0.05 Hz–28 Hz.

NORMAL: The range of change for the LFO frequency will be from 0.05 Hz–28 Hz.

BPM: This synchronizes the LFO frequency to the sequencer's BPM (beats per minute) set in each program.

RATE knob [0...1023 / 4, 2, 1, 0, 3/4...1/64]

The RATE knob adjusts the frequency of the LFO.

Turning the knob to the right will increase the LFO frequency.

INT knob [0...511]

The INT knob adjusts the intensity of the LFO.

Turning the knob to the right will increase the LFO intensity.

Tip: When turning the INT knob while holding down the SHIFT button, the LFO waveform will be inverted. The setting range is 0–511.

TARGET switch [CUTOFF, SHAPE, PITCH]

Selects the parameter where the LFO modulation will be applied.

CUTOFF: Modulation is applied according to the VCF CUTOFF knob setting.

SHAPE: Modulation is applied according to the SHAPE knob setting for the oscillator, which is set in "LFO Target OSC" (p.37) of PROGRAM EDIT mode.

PITCH: Modulation is applied according to the PITCH knob setting for the oscillator, which is set in "LFO Target OSC" (p.37) of PROGRAM EDIT mode.

EFFECTS section

The minilogue xd features high-definition digital effects. You can select one variation from each effect including delay, reverb and modulation, and combine them. Use the DEL/REV/MOD switch to select the effect type to set. Next, use the OFF/ON/SELECT switch and the TIME and DEPTH knobs to set how the effect will be applied. The effect on/off state and the values of the TIME and DEPTH knobs are saved along with each effect, so the sound that you set will remain in memory, even if you use the DEL/REV/MOD switch to switch the effect.

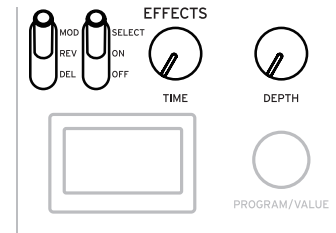

DEL/REV/MOD switch [DEL, REV, MOD]

Selects the effect type.

DEL: Selects the delay effect.

REV: Selects the reverb effect.

MOD: Selects the modulation effect.

OFF/ON/SELECT switch [OFF, ON, SELECT]

This sets the effect that you have selected using the DEL/REV/MOD switch.

OFF: Turns the effect off.

ON: Turns the effect on.

SELECT: When either “DEL” or “REV” is selected using the DEL/REV/MOD switch, flip the switch to SELECT to switch between the sub-types for each effect.

When “MOD” is selected using the DEL/REV/MOD switch, flip the switch to SELECT to switch between the effect types (CHORUS → ENSEMBLE → PHASER → FLANGER → USER → CHORUS → ...). When switching between sub-types, flip the switch to SELECT while holding the SHIFT button down.

Tip: USER (user effects) are not installed as factory-set default effects, so they cannot be selected, but you can load them into the minilogue xd to make them selectable. See the “logue SDK” (www.korg.com) for details.

Note: Both delay and reverb user effects cannot be used at the same time. The effect last selected will be enabled.

For details on the effect types and sub-types, refer to “Effects list” (p.56).

TIME knob

This knob specifies the delay time, reverb time or modulation time. The setting range differs depending on the effect type you select.

Turning the knob to the right will increase the speed or lengthen the time.

DEPTH knob [0.0%... 100%]

This sets the depth of the effect.

Turning the knob to the right will increase the intensity.

Tip: When either “DEL” or “REV” is selected using the DEL/REV/MOD switch, turn the DEPTH knob while holding down the SHIFT button to adjust the wet/dry balance of each effect. The setting range is MIX WET: 0% – BALANCED – MIX DRY: 0%.

Sequencer

In this section, we'll explore recording with the sequencer, one of the elements that makes up a program. This includes real-time recording, step recording and motion sequence recording, as well as how to edit the recorded sequences (step edit).

We recommend that you save the sequences you have recorded on the minilogue xd.

- ⚠ The sequence data that you record will be lost if you turn off the power or recall a different program before saving.

Step recording

1. **Press the REC button in the SEQUENCER section while the sequencer is stopped.**

"STEP REC" and "STEP 1" will be indicated in the display.

If the sequence has already been recorded, the note names will be indicated in the display.

Tip: Select the step you wish to edit. For instance, press button 3 to select step 3.

2. **Use the keyboard, REST button and other controls to edit the notes.**

When you record a note, rest, or tie in step mode, the display will automatically move to the next step.

Recording notes

The note name for the keys you press on the keyboard will be indicated in the display. Check the note name in the display, and if it is correct, release your finger to record that note and to move to the next step.

The note that you played just before releasing your fingers from the keys will be recorded. If you play a wrong note, do not release the key; instead, keep your finger on the wrong note while playing the right note. Check the note indicated in the display, and take your finger off the keyboard to move to the next step.

The "Default Gate Time" (p.40) value from SEQ EDIT mode will be used for the note length during recording. If you turn the PROGRAM/VALUE knob while playing the keyboard, the gate time for only the note(s) you played will be changed when recording. If you turn the PROGRAM/VALUE knob while playing buttons 1–16, the gate time for only the step(s) you played will be changed.

Recording a rest

You can record a rest by pressing the REST button.

Recording a tie

Press the REST button while holding down a key. The note will be tied to the next note and recorded.

3. **When the set number of steps have finished recording, step recording will automatically end.**

The number of steps is set for each program. You can change the number of steps using the "Step Length" (p.40) function in the SEQ EDIT mode. Turn the PROGRAM/VALUE knob to change the step length during step recording.

Tip: Pressing the REC button at any step during recording will stop the step recording at that step.

Real-Time recording

This feature allows you to record your keyboard performance on the minilogue xd and add overdubs (recording while adding performance data) in real time.

1. **Press the PLAY button in the SEQUENCER section while the sequencer is stopped.**

If a recording already exists, the sequence data will begin playing.

2. **Press the REC button.**

Real-time recording will begin, and the REC button will light.

3. **Play the keyboard.**

The note(s) you play will be recorded.

4. **Press the REC button once more to stop the recording.**

The REC button will go dark.

Press the REC button once more to start recording again.

Tip: When you hold down the REST button during real-time recording, the existing notes in the sequence will be deleted.

5. **Press the PLAY button to finish real-time recording.**

The PLAY button will go dark.

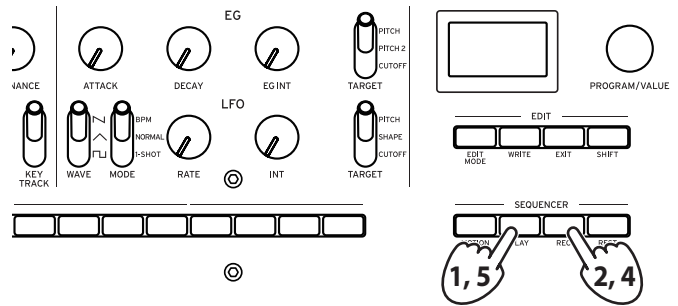

Recording a motion sequence

Motion sequencing allows you to record the flipping of switches and the turning of knobs as part of the sequence, and recreate those motions automatically during playback.

Up to four motion sequences can be recorded, which includes changes to the knobs and switches.

Note: The knobs, switches for which you cannot record motions are as follows.

MASTER knob, TEMPO knob, OCTAVE switch (MASTER), MULTI ENGINE TYPE-USR, DRIVE switch (FILTER), DEL/REV/MOD switch, SELECT setting of the OFF/ON/SELECT switch.

1. **Press the PLAY button to play the sequencer, and then press the MOTION MODE button.** "MOTION VIEW" will appear in the display, and the motion sequence saved to the program will show up as a visual graphic.



2. **Press the REC button.**
Real-time recording will begin.
3. **Move the knobs and switches on the minilogue xd.**
You can record up to four motion sequences for the knobs and switches.
Note: If you exceed this limit, the message "Motion Full" will be shown in the display, and the display will enter MOTION CLEAR in the SEQ EDIT mode. See steps 2 and afterwards in "Deleting a motion sequence" (p.30) for details.
Note: For motion sequences of knobs and switches you moved that are already recorded, the data previously recorded will be overwritten.
4. **After the set number of steps have finished recording, the Motion Sequence will automatically finish recording as well.**
Follow steps 2 and on to record motion sequences for other knobs and switches. The number of steps is set for each program. You can change the number of steps using the "Step Length" (p.40) function in the SEQ EDIT mode.

Deleting a motion sequence

You can delete one of the previously recorded motion sequences from “MOTION CLEAR (1...4)” (p.41) in SEQ EDIT mode.

Tip: To delete all motion sequences at once, use “Motion Clear” (p.41) in SEQ CLEAR, SEQ EDIT mode.

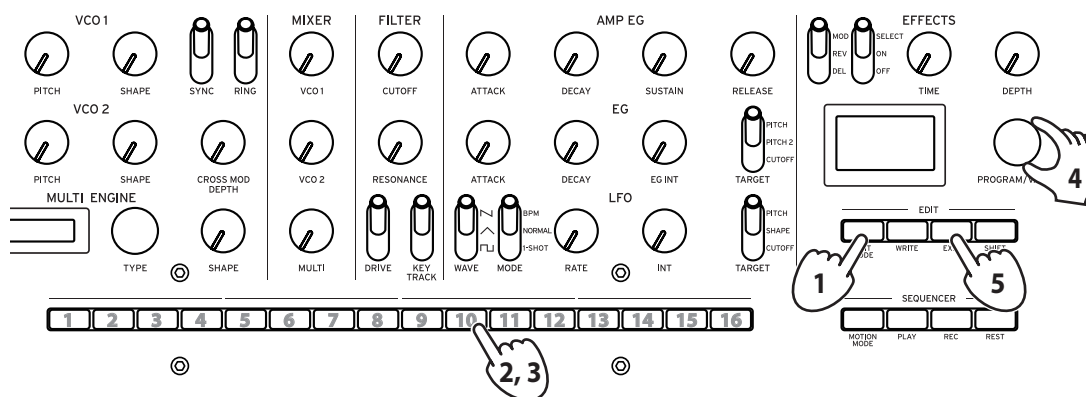

1. Press the EDIT MODE button a number of times to select SEQ EDIT mode.



2. Press button 10 to enter MOTION CLEAR.



Tip: While the SHIFT button is pressed, the MOTION VIEW screen will be displayed, where you can see the graphics for the motion sequences you have recorded.

3. Press button 10 a number of times to select the motion sequence to delete.
4. Turn the PROGRAM/VALUE knob to select “CLEAR...?”, and press the WRITE button. The selected motion sequence will be deleted.
5. Press the EXIT button.

Editing sequence data (step edit)

Using Step Edit, you can edit the notes and motion sequences that you previously recorded into sequence data.

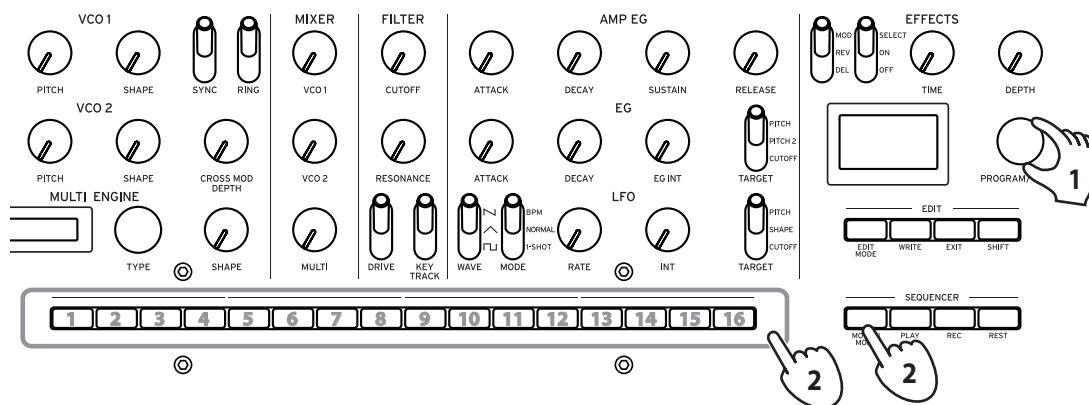

1. Select a program that includes the sequence data you wish to edit.

The MOTION MODE button and buttons 1–16 will light and go dark to show the status for each step.

	Buttons 1–16	Button goes dark	Button lights
MOTION MODE button		Disabled, or no note data available	Enabled (note data is recorded)
Button goes dark		Disabled, or no motion sequence data	Enabled (motion sequence data is recorded)
Button lights			

2. Edit the notes and motion sequences for the steps, using the MOTION MODE button and buttons 1–16.

Play the note.

Doing so will make the MOTION MODE button go dark.

- Hold down one of buttons 1–16 and play a note on the keyboard to record a note at that step.
- Holding down multiple buttons 1–16 and playing a note on the keyboard will record the same note at all of the selected steps.
- Holding down multiple buttons 1–16 next to each other and playing a note on the keyboard will connect the notes inputted in these steps with a tie.
- If you turn the PROGRAM/VALUE knob while playing buttons 1–16, the gate time for only the step(s) you played will be changed. See “Default Gate Time” (p.40) for details on setting the gate time.

Input a motion sequence.

Doing so will make the MOTION MODE button light up.

Tip: When the MOTION MODE button is lit, the recorded motion sequence will show up as graphics in the display.

- Hold down one of buttons 1–16 and move a knob or switch to record a motion sequence at that step.
- Holding down multiple buttons 1–16 and moving a knob will record the motion sequence at all of the selected steps.

For example, if you hold down buttons 3 and 5 and turn the LFO INT knob to “50%,” the LFO INT 50% value will be recorded for steps 3 and 5 respectively. When recording a motion sequence in real time, you can only record continuous changes in value. However, if you use the step recording feature to record changes as a motion sequence, the changes recorded as a motion sequence will be recorded per step.

Enable or disable the steps.

- Press buttons 1–16 to enable (the button will light) or disable (the button will go dark) the steps.

Note: If a note or motion sequence is not recorded for a step, you cannot enable that step.

- 3. After you finish step editing, press the PLAY button to check your sequence data.**
The PLAY button will light.

Other editing functions

Use the SEQ EDIT mode when setting the step length, step resolution and other parameters during sequence step recording, as well as for deleting sequence data, or for editing or deleting motions. See “SEQ EDIT mode” (p.40) for details.

Edit mode

Although nearly all of the minilogue xd's main parameters can be edited using the knobs and switches on the panel, the other detailed parameters are accessed using the **Edit mode**. There are three sub-modes within the Edit mode: **PROGRAM EDIT mode**, **SEQ EDIT mode**, and **GLOBAL EDIT mode**.

How to enter the Edit mode

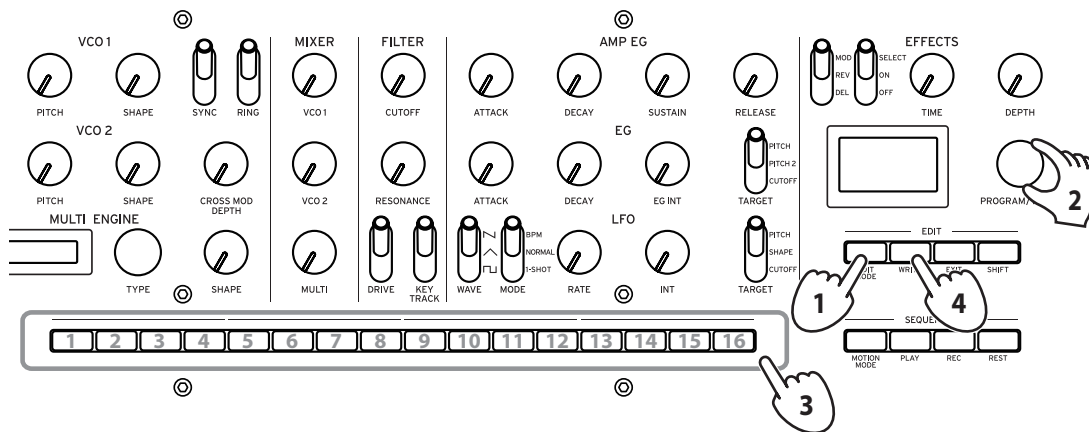

1. Press the EDIT MODE button.

Each Edit mode is shown in the display, and the buttons light.



2. Press the EDIT MODE button a number of times or use the PROGRAM/VALUE knob to select PROGRAM EDIT mode, SEQ EDIT mode, or GLOBAL EDIT mode.

PROGRAM EDIT mode: This mode is used for program editing functions, such as to change the program name and assign a parameter to the joystick or CV INPUT jack, as well as to select a microtuning and so on.

SEQ EDIT mode: This mode is used to set the BPM and configure other step sequencer settings, as well as to delete sequence data and so on.

GLOBAL EDIT mode: Use this mode to set how the knobs and switches should function, as well as settings such as MIDI for the entire synthesizer.

3. Press one of the lit buttons from 1 to 16.

The minilogue xd will enter the selected edit mode, and the parameter names will be indicated in the display.

- You can go to the page at right by pressing the same button. Press the same button while holding the SHIFT button down to show the page to the left.
- Turn the PROGRAM/VALUE knob to set the parameters. For more on the parameters, see "PROGRAM EDIT mode" (p.35), "SEQ EDIT mode" (p.40) and "GLOBAL EDIT mode" (p.42).

4. Press the WRITE button to save your parameters after you have configured the parameters in PROGRAM EDIT mode and SEQ EDIT mode.

Tip: Settings in GLOBAL EDIT are saved automatically when going to a different page.

- ⚠ If you select another program after you have configured the parameters in the PROGRAM EDIT mode and the SEQ EDIT mode without saving your changes, your settings will be lost.

Edit mode parameter list

Button	1	2	3	4	5	6	7	8	9	10	11	12	13	14	15	16
PROGRAM EDIT mode				JOYSTICK (p.35)	CV INPUT (p.36)	PITCH SETTING (p.36)	LFO (p.37)	MODULATION (p.38)	OTHER SETTINGS (p.38)	MULTI ENGINE (p.39)		PROGRAM NAME (p.39)	INITIALIZE (p.40)	DUMP (p.40)		
				X+ Bend Range	CV IN Mode	Microtuning	LFO Target OSC	EG Velocity	Multi Octave	Parameter 1 (Feedback)		PROGRAM NAME	Initialize Program	Program Dump		
				X- Bend Range	CV IN1 Assign	Scale Key	LFO Key Sync	Amp Velocity	Multi Routing	Parameter 2 (Noise Depth)						
				Y+ Assign	CV IN1 Range	Program Tuning	LFO Voice Sync		EG Legato	Parameter 3 (Shape Mod Int)						
				Y+ Range	CV IN2 Assign	Transpose			Portamento Mode	Parameter 4 (Mod Attack)						
				Y- Assign	CV IN2 Range				Portamento BPM	Parameter 5 (Mod Decay)						
			Y- Range					Program Level	Parameter 6 (Mod Key Track)							
SEQ EDIT mode					BPM (p.40)	SEQ PARAMETER (p.40)	SEQ CLEAR (p.41)			MOTION CLEAR (p.41)	MOTION ENABLE (p.41)	MOTION SMOOTH (p.41)				
					BPM	Step Length	All Clear			MOTION CLEAR (1...4)	MOTION ENABLE (1...4)	MOTION SMOOTH (1...4)				
						Step Resolution	Motion Clear									
						Swing										
						Default Gate Time										
GLOBAL EDIT mode			GLOBAL 1 (p.42)	GLOBAL 2 (p.42)	GLOBAL 3 (p.44)	GLOBAL 4 (p.44)	GLOBAL 5 (p.45)	GLOBAL 6 (p.46)		USER SCALE (p.46)	USER OCTAVE (p.46)	USER CLEAR (p.47)	USER DUMP (p.47)		ALL DUMP (p.47)	
			Master Tune	Metronome	Sync In Unit	MIDI Route	MIDI Rx Prog Chg	Parameter Disp		User Scale 1...6	User Octave 1...6	User Scale 1...6	User Scale 1...6		All Dump (USB)	
			Transpose	D. Pedal Polarity	Sync Out Unit	MIDI Ch	MIDI Rx CC	Brightness				User Octave 1...6	User Octave 1...6		All Dump (MIDI)	
				Local SW	Sync In Polarity	Clock Source	MIDI Rx Pitch Bend	Auto Power Off								
				Velocity Curve	Sync Out Polarity	En Rx Transport	MIDI Tx Prog Chg									
				Knob Mode		Poly Chain	MIDI Tx CC									
						MIDI Tx Pitch Bend										

PROGRAM EDIT mode

Button 4 (JOYSTICK)

This configures the joystick settings.

X+ Bend Range [Off, 1 Note...12 Note]

Specifies how much pitch bend will be applied when moving the joystick to the right.

X- Bend Range [Off, 1 Note...12 Note]

Specifies how much pitch bend will be applied when moving the joystick to the left.

Y+ Assign [GATE TIME...DELAY DEPTH]

This sets the parameters that are assigned to the joystick when moved upwards.

The parameters that can be assigned as shown below.

GATE TIME	A.EG DECAY
PORTAMENTO	A.EG SUSTAIN
VOICE MODE DEPTH	A.EG RELEASE
VCO1 PITCH	EG ATTACK
VCO1 SHAPE	EG DECAY
VCO2 PITCH	EG INT
VCO2 SHAPE	LFO RATE
CROSS MOD	LFO INT
MULTI SHAPE	MOD TIME
VCO1 LEVEL	MOD DEPTH
VCO2 LEVEL	REVERB TIME
MULTI LEVEL	REVERB DEPTH
CUTOFF	DELAY TIME
RESONANCE	DELAY TIME
A.EG ATTACK	

Y+ Range [-100%...0%...+100%]

This sets how much the parameters are changed when the joystick is moved upwards.

Y- Assign [GATE TIME...REVERB DEPTH]

This sets the parameters that are assigned to the joystick when moved downwards.

The parameters that can be assigned are the same as those for Y+ Assign. See "Y+ Assign" (p.35) for details.

Y- Range [-100%...0%...+100%]

This sets how much the parameters are changed when the joystick is moved downwards.

Button 5 (CV INPUT)

Two CV IN jacks are available on the minilogue xd. These jacks let you control the internal parameters via CV (control voltage) input, by connecting a modular synthesizer or other device to the minilogue xd. CV/Gate signals are also supported.

CV IN Mode [Modulation, CV/Gate]

Sets the input mode for the CV IN 1, 2 jacks.

Modulation: Controls the parameters assigned in “CV IN1 Assign” (p.36) and “CV IN2 Assign” (p.36).

The input voltage range in modulation mode is from -5V to 5V.

CV/Gate: CV1 IN1 is the input jack for pitch CV signals, and CV2 IN2 is the input jack for gate signals. Standard CV (control voltage) and gate signals will play the notes on the minilogue xd. The CV input voltage range in CV/Gate mode is from -3V to 5V. Inputting a 1V signal will generate a C4 note. The minilogue xd is compatible with standard volt/oct signals. The ideal gate signal is a 0-5V pulse.

CV IN1 Assign [GATE TIME...REVERB DEPTH]

This sets the parameters that are controlled by the CV inputted to the CV IN1 jack.

The parameters that can be assigned are the same as those for Y+ Assign. See “Y+ Assign” (p.35) for details.

Note: The parameters cannot be set when CV IN Mode is set to “CV/Gate.”

CV IN1 Range [-100%...0%...+100%]

This sets the degree of change to the parameters by the CV inputted to the CV IN1 jack.

CV IN2 Assign [GATE TIME...REVERB DEPTH]

This sets the parameters that are controlled by the CV inputted to the CV IN2 jack.

The parameters that can be assigned are the same as those for Y+ Assign. See “Y+ Assign” (p.35) for details.

Note: The parameters cannot be set when CV IN Mode is set to “CV/Gate.”

CV IN2 Range [-100%...0%...+100%]

This sets the degree of change to the parameters by the CV inputted to the CV IN2 jack.

Button 6 (PITCH SETTINGS)

Microtuning [Equal Temp...Reverse, AFX 001...006, DC 001...003, USER SCALE 1...6, USER OCTAVE 1...6]

Sets the microtuning for the program.

Equal Temp: Spacing all semitones at equal pitch intervals, this temperament is the most widely used.

Pure Major: Major chords in the primary key selected will be perfectly in tune.

Pure Minor: Minor chords in the primary key selected will be perfectly in tune.

Pythagorean: This ancient Greek scale is especially effective for playing melodies. It consists of perfect fifths; however, other intervals—the major third in particular—will sound out of tune.

Werckmeister: The Werckmeister III scale was used in the later Baroque period, providing equal temperament tuning.

Kirnberger: The Kirnberger III scale is used mainly for tuning harpsichords.

Slendro: This is an Indonesian gamelan scale with five notes per octave.

Pelog: This is an Indonesian gamelan scale with seven notes per octave.

Ionian: This is a major scale with seven notes per octave.

Dorian: This is a scale with seven notes per octave, with the sixth note of the Ionian scale raised a semitone.

Aeolian: This is a natural minor scale with seven notes per octave.

Major Penta: This is a major pentatonic scale.

Minor Penta: This is a minor pentatonic scale.

Reverse: This is a scale that symmetrically inverts the notes on the keyboard, with C4 as the center.

AFX 001...006: These are an original scale created by Aphex Twin, set for the entire note range.

DC 001...003: These are an original scale created by Dorian Concept, set for the entire note range.

USER SCALE 1...6: These are a user-defined scale based on equal temperament tuning, which lets you alter the pitches of each note over the entire keyboard range in semitones and cents. Refer to "Microtuning" (p.48) for how to set this.

USER OCTAVE 1...6: These are a user-defined scale based on equal temperament tuning, which lets you alter the pitches of each note in semitones and cents over one octave (C through B). Refer to "Microtuning" (p.48) for how to set this.

Scale Key **[-12 Note...0 Note...+12 Note]**

Sets the scale key used in microtunings.

The preset tuning is the key of C. Adjust the "Scale Key" setting if you want to use a different key. For example, set the scale key to "+2 Note" if you want to use the key of D.

Note: This setting will have no effect if microtuning is set to "Equal Temp" (equal temperament tuning).

Program Tuning **[-50 Cent...0 Cent...+50 Cent]**

This adjusts the tuning of the program in one-cent units (1 semitone=100 cents), over a range of ±50 cents.

Transpose **[-12 Note...0 Note...+12 Note]**

Sets the pitch for the program in semitones. The range you can set is within one octave, up and down.

Button 7 (LFO)

LFO Target OSC **[All, VCO1+2, VCO2, Multi]**

This selects the oscillator that modulation will be applied to.

All: Modulation is applied to oscillators 1 and 2, as well as the MULTI ENGINE.

VCO1+2: Modulation is applied to oscillators 1 and 2.

VCO2: Modulation is applied to oscillator 2.

Multi: Modulation is applied to the MULTI ENGINE.

LFO Key Sync **[Off, On]**

Selects whether the phase of the LFO will be reset with each note-on received from the keyboard.

LFO Voice Sync **[Off, On]**

Use the LFO Voice Sync to choose whether the phase of the LFO will be synchronized between voices.

Button 8 (MODULATION)

EG Velocity [0..127]

Sets the strength of the Cutoff EG Int using velocity. EG Velocity is used to specify how much the EG Int will change according to the keyboard velocity.

If EG Int is set to any other value besides "0", the keyboard velocity can be used to soften the EG Int.

Amp Velocity [0..127]

Amp Velocity is used to specify how much the volume will change according to the keyboard velocity.

0: The velocity will have no effect.

The larger the value, the more effect that keyboard velocity will have.

Button 9 (OTHER SETTINGS)

Multi Octave [16', 8', 4', 2']

You can set the transposition of the MULTI ENGINE in octaves.

Multi Routing [Pre VCF, Post VCF]

This sets whether the MULTI ENGINE is mixed prior to the signal reaching the VCF, or whether to bypass the VCF and mix.

Note: When this is set to "Post VCF," the VCF will not affect the MULTI ENGINE.

EG Legato [Off, On]

When the voice mode is set to "UNISON" or "CHORD," this sets what happens with the EG when a key is played in legato while another key is being pressed.

Off: The EG will be retriggered.

On: The EG will not be retriggered.

Portamento Mode [Auto, On]

Auto: When playing in a legato style (playing a new note before any previously played note is released), portamento will be applied.

On: Portamento will be applied, even when fully releasing a key and then playing the next note.

Portamento BPM [Off, On]

On: The length of portamento that is set using the PORTAMENTO knob will be synchronized with the BPM (beats per minute).

Program Level [-18.0dB...0.0 dB...+6.0dB]

Sets the program volume.

This allows you to adjust the volume of a program relative to other programs.

Increasing this value will make the volume louder.

Button 10 (MULTI ENGINE)

This button configures the MULTI ENGINE settings.

The parameters that are displayed will change, depending on the settings in “NOISE/VPM/USR switch” (p.19), MULTI ENGINE.

When the noise generator is selected

There are no parameters to set for the noise generator.

When the VPM oscillator is selected

The VPM oscillator has 16 types, each with six parameters.

You can set these parameters to make changes to the sound.

If all parameters are set to “0%”, the effects set in the types will be used, and the effect will increase as the value is increased (+).

Parameter 1 (Feedback) [-100%...0%...+100%]

Sets the depth of the modulator feedback.

Parameter 2 (Noise Depth) [-100%...0%...+100%]

Adjusts the depth of the noise modulation.

Parameter 3 (Shape Mod Int) [-100%...0%...+100%]

Adjusts the depth of the internal EG effect.

Parameter 4 (Mod Attack) [-100%...0%...+100%]

Adjusts the attack time of the internal EG.

Parameter 5 (Mod Decay) [-100%...0%...+100%]

Adjusts the decay time for the internal EG.

Parameter 6 (Mod Key Track) [-100%...0%...+100%]

Adjusts the depth of the modulator effect via keyboard tracking. The higher the sound frequency, the less noticeable the effect becomes.

When the user oscillator is selected

See the “logue SDK” (www.korg.com) for details.

Button 12 (PROGRAM NAME)

PROGRAM NAME

You can create a program name up to 12 characters in length.

Rotate the PROGRAM/VALUE knob to select the desired character, then press button 12 to move the cursor to the next position.

Button 13 (INITIALIZE)

Initialize Program

This initializes the currently selected program.

Turn the PROGRAM/VALUE knob until "Press WRITE" is indicated in the display.

Press the WRITE button to initialize the program. The display will indicate the message "Initialized".

Button 14 (DUMP)

Program Dump

Transmits the SysEx data for the currently selected program to another minilogue xd, MIDI data filer, computer or other compatible device that is connected to this instrument.

Turn the PROGRAM/VALUE knob until "Press WRITE" is indicated in the display.

Press the WRITE button to send a SysEx program dump from the minilogue xd's MIDI OUT and USB B port. The message "Transmitting" will be shown in the display during data transmission.

SEQ EDIT mode

Button 5 (BPM)

BPM [10.0...300.0]

This parameter sets the tempo of the sequencer in beats per minute (BPM).

Button 6 (SEQ PARAMETER)

This group provides control of various sequencer timing and resolution parameters such as Gate Time, Swing, etc.

Step Length [1...16]

Step Length allows you to set the number of steps used by the Step Sequencer.

Turn the PROGRAM/VALUE knob to change the number of steps during step recording.

Step Resolution [1/16, 1/8, 1/4, 1/2, 1/1]

The step resolution is used to set the length of each step in the step sequencer.

1/16: A single step will be set to the length of a sixteenth note.

1/1: A single step will be set to the length of one measure. Use this when you want to play long chords.

Swing [-75%...0%...+75%]

The Swing parameter adjusts the intensity of the swing. When the voice mode is "ARP", the value set here is also used for the arpeggiator swing.

Default Gate Time [0%...100%]

The Gate Time is the default value used for each step recorded using the step sequencer. Lower values are more staccato, higher values have a longer gate time. When the voice mode is "ARP", the value set here is also used for the arpeggiator gate time.

Button 7 (SEQ CLEAR)

This function provides a convenient way to delete all data within a specific sequence.

All Clear

When using All Clear, all notes and motion sequences contained within the sequence data will be deleted.

Turn the PROGRAM/VALUE knob until "Press WRITE" is indicated in the display.
Press the WRITE button to delete. The display will then indicate the message "Cleared".

Motion Clear

With Motion Clear, only the motion sequences contained within the sequence data will be deleted.

Turn the PROGRAM/VALUE knob until "Press WRITE" is indicated in the display.
Press the WRITE button to delete all of the motion sequence data. The display will then indicate the message "Cleared".

Button 10 (MOTION CLEAR)

MOTION CLEAR (1...4)

You can delete motion sequences one at a time here. See "Deleting a motion sequence" (p.30) for details.

Tip: While the SHIFT button is pressed, the MOTION VIEW screen will be displayed, where you can see the graphics for the motion sequences you have recorded.

Button 11 (MOTION ENABLE)

MOTION ENABLE (1...4) [OFF, ON]

Use this to enable or disable motion 1–4.

OFF: The motion sequence will be disabled, and the parameters will not change (the recorded motion sequence will not be deleted).

Press button 11 to select the motion sequence to configure, and turn the PROGRAM/VALUE knob to select either "OFF" or "ON".

Tip: While the SHIFT button is pressed, the MOTION VIEW screen will be displayed, where you can see the graphics for the motion sequences you have recorded.

Button 12 (MOTION SMOOTH)

MOTION SMOOTH (1...4) [OFF, ON]

The motion of a motion sequence (Motion 1–4) can step from one value to the next, or it can transition smoothly from one value to the next by applying MOTION SMOOTH.

OFF: The motion sequence will make changes to the sound in steps.

ON: The motion sequence will change smoothly, and make smooth changes to the sound.

Press button 12 to select the motion sequence to configure, and turn the PROGRAM/VALUE knob to select either "OFF" or "ON".

Tip: While the SHIFT button is pressed, the MOTION VIEW screen will be displayed, where you can see the graphics for the motion sequences you have recorded.

GLOBAL EDIT mode

Button 3 (GLOBAL 1)

This button sets the parameters related to the overall pitch (how high or low the sound is). These functions control the tuning and transposition of the minilogue xd.

Master Tune [-50 Cent...0 Cent...+50 Cent]

This adjusts the overall tuning of the entire minilogue xd in one-cent units (semitone = 100 cents), over a range of ± 50 cents.

0: A4 is equal to 440 Hz.

Transpose [-12 Note...0 Note...+12 Note]

Sets the pitch in semitones. The range you can set is within one octave, up and down.

Button 4 (GLOBAL 2)

Metronome [Off, On]

Sets whether the metronome will sound during real-time recording.

D. Pedal Polarity [- (KORG), +]

Sets polarity to the same polarity as the damper pedal that is connected to the DAMPER jack. If the polarities do not match, the damper pedal will not operate correctly.

- (KORG): Use this setting when connecting an optional DS-1H damper pedal (sold separately) or a PS-3/PS-1 pedal switch (sold separately). The polarity of Korg damper pedals and pedal switches is “-” (↓ : open type).

+: Use this setting when connecting damper pedals with a “+” polarity (↑ : closed type). If the polarities do not match, the damper pedal will not operate correctly.

Local SW [Off, On]

Sets the local control.

Normally, this is “On.” However, if you are using the minilogue xd with an external sequencer or sequencing software, you will want to set the local connection to “Off” to eliminate the double-triggering of notes caused by MIDI echo.

Off: Disconnects the keyboard (**xd-m**) buttons 1–16) from the tone generator.

Velocity Curve [Type 1...8, Const 127]

This selects how the minilogue xd changes the volume and sound, in response to velocity (how hard you strike the keys).

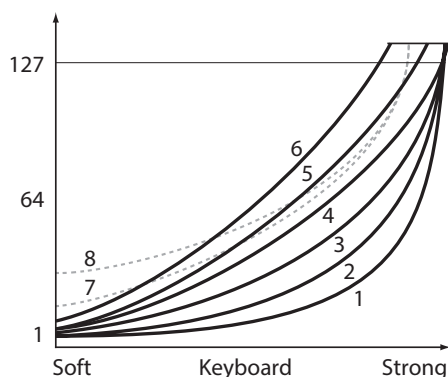

Type 1	This curve requires you to play strongly in order to produce an effect.
Type 2, 3	:
Type 4	This is a typical curve.
Type 5	:
Type 6	This curve produces an effect without requiring you to play very strongly.
Type 7	This curve produces a fairly steady effect with little change for medium-strength playing.
Type 8	This curve produces a fairly steady effect with little change for medium-strength playing (a flatter curve than 7).
Const 127	All notes will sound at maximum velocity.

Curve types 7 and 8 produce little change for medium-strength playing, and are suitable when keyboard velocity is not required, or when you want to play each note at the same velocity. However, these curves will produce a great deal of change with softly played notes, so the sound may be more difficult to control. Choose the curve that is most appropriate for your playing dynamics or for the effect you want to obtain.

Knob Mode **[Jump, Catch, Scale]**

The front panel knobs can operate in one of three modes:

Jump: When you turn the knob, the parameter value will jump to the value indicated by the knob. Since this makes it easy to hear the results while editing, we recommend that you use this setting.

Catch: Turning the knob will not change the parameter value until the knob position matches the stored value. We recommend that you use this setting when you don't want the sound to change abruptly, such as while performing.

Scale: When you turn the knob, the parameter value will increase or decrease in a relative manner in the direction that it is turned. When you turn the knob and it reaches the full extent of its motion, it will operate proportionate to the maximum or minimum value of the parameter. Once the knob position matches the parameter value, the knob position and parameter value will subsequently be linked.

If the parameter value does not change

In some cases, the parameter value may not change, even when you turn the knob from left to right. This means that the knob mode is set to "Catch".

In this case, the actual value of the parameter you're editing (the value shown in the display) will not change unless it matches the position of the knob. In Catch mode, the knob position and the value will be linked only when the knob position reaches the actual value. This prevents an unnatural change in sound that is caused when a value suddenly changes.

Let's say that you've turned the knob to edit a certain parameter, and that the knob is in the position shown.



The actual value of the parameter is at the position shown by the triangle. The parameter value will not change until the knob position reaches the triangle mark.

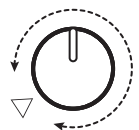

Once the knob has reached the position corresponding to the actual value, the parameter value and the knob position will be linked, and the value will change as you turn the knob.



Button 5 (GLOBAL 3)

These parameters relate to the SYNC IN and OUT jacks settings.

Sync In Unit [16th Note, 8th Note]

This sets how much the arpeggiator will advance with each pulse received via the SYNC IN jack.

16th Note: The sequencer will advance one sixteenth note for each pulse.

8th Note: The sequencer will advance one eighth note for each pulse.

Sync Out Unit [16th Note, 8th Note]

This sets when to send each pulse via the SYNC OUT jack, according to how far the arpeggiator has advanced.

16th Note: A pulse will be outputted for every sixteenth note.

8th Note: A pulse will be outputted for every eighth note.

Sync In Polarity [Rise, Fall]

In order to achieve synchronization with other units, the polarity of the SYNC IN jack may need to be changed.

Rise: The minilogue xd will create a sync pulse as it rises to its crest (the highest point) of the waveform.

Fall: The minilogue xd will create a sync pulse as it falls to its trough (the lowest point) of the waveform.

Sync Out Polarity [Rise, Fall]

In order for other units to correctly sync with the minilogue xd, the polarity of the SYNC OUT jack may need to be changed.

Rise: The minilogue xd will create a sync pulse as it rises to its crest (the highest point) of the waveform.

Fall: The minilogue xd will create a sync pulse as it falls to its trough (the lowest point) of the waveform.

Button 6 (GLOBAL 4)

These parameters relate to the minilogue xd's MIDI capabilities.

MIDI Route [USB+MIDI, USB]

MIDI signals can be sent and received via the MIDI connector and USB port, or by the USB port alone.

USB+MIDI: MIDI messages are received via the USB B port and the MIDI IN connector; messages are transmitted from the USB B port and the MIDI OUT connector.

USB: MIDI messages will be transmitted and received only via the USB B port. When using the USB port as a MIDI interface, it is advantageous to use this setting.

MIDI Ch [1...16]

Specifies the MIDI channel of the minilogue xd.

This MIDI channel is used to transmit and receive note messages, as well as control change messages like pitch bend and data dump messages.

Clock Source [Auto (USB), Auto (MIDI), Internal]

Many features of the minilogue xd can be synchronized to the tempo or BPM. This parameter specifies whether the clock source is internal, or an external MIDI clock source.

Auto (USB), Auto (MIDI): When there is no input, the internal clock will be used. When input is detected, the internal clock will be synchronized to external MIDI clocks from the USB B and MIDI IN connectors respectively.

Internal: Only the internal clock will be used.

- 🔊 When a cable is plugged into the SYNC IN jack, the internal clock is synchronized to the SYNC IN jack clock, regardless of the MIDI clock settings.

En Rx Transport [Off, On]

Sets whether transport-related messages received as part of MIDI real-time messages such as start, stop and continue will be received.

Poly Chain [Off, Master, Slave]

Sets the poly-chain function.

Off: Use the “Off” setting when you will not be connecting devices in poly-chain.

Master: Sets this as the master side device when connecting in poly-chain.

Slave: Sets this as the slave side device when connecting in poly-chain.

- Note:** You cannot operate devices that are set to “Slave,” besides configuring the global settings and using the MASTER knob, tone parameters are determined by the “Master” unit.

Button 7 (GLOBAL 5)

MIDI Rx Prog Chg [Off, On]

Selects whether MIDI program change messages will be received.

MIDI Rx CC [Off, On]

Selects whether MIDI control change messages will be received.

- Tip:** CC#1 (Modulation Wheel), CC#64 (Damper) and CC#120 onward cannot be controlled using this setting.

MIDI Rx Pitch Bend [Off, On]

Selects whether MIDI pitch bend messages will be received.

MIDI Tx Prog Chg [Off, On]

Selects whether MIDI program change messages will be transmitted.

MIDI Tx CC [Off, On]

Selects whether MIDI control change messages will be transmitted.

MIDI Tx Pitch Bend [Off, On]

Selects whether MIDI pitch bend messages will be transmitted.

Button 8 (GLOBAL 6)

These parameters relate to the minilogue xd's display and power settings.

Parameter Disp [Normal, All]

Normal: Only major information such as operating the pitch-related knobs or switching the effect types will be displayed.

All: When any knob except for the MASTER knob and the MULTI ENGINE TYPE knob are turned, the value is shown; and when operating a switch, the setting is shown. Parameters for switches that have an LED may not show up in the display.

Brightness [1...10]

Adjusts the display brightness.

- ⚠ Continuous use of the minilogue xd while the brightness is set to a high value will have an adverse effect on the overall life of the display.

Auto Power Off [Off, On]

Sets whether the **auto power off feature** is enabled.

Off: The auto power off feature will be disabled.

On: The auto power off feature is enabled. When the minilogue xd is not played or operated for four hours, the power will automatically shut down. See "Auto power off feature" (p.9) for details.

Button 10 (USER SCALE)

USER SCALE 1...6

These are user-defined scales based on equal temperament tuning. You can alter the pitches of each note over the entire keyboard range in semitones and cents for each user scale.

Turn the PROGRAM/VALUE knob to set the tuning value in cents. Turn the PROGRAM/VALUE knob while holding down the SHIFT button to adjust the tuning value in semitones (100 cents). See "Microtuning" (p.48) for details.

- ⚠ When this parameter is displayed, the minilogue xd can receive SysEx microtuning messages. This will overwrite the scale contents you are currently editing, regardless of the numbers specified in the messages.

Button 11 (USER OCTAVE)

USER OCTAVE 1...6

This adjusts the pitches of each note in semitones and cents over one octave (C through B), based on equal temperament tuning.

Turn the PROGRAM/VALUE knob to set the tuning value in cents. Turn the PROGRAM/VALUE knob while holding down the SHIFT button to adjust the tuning value in semitones (100 cents). See "Microtuning" (p.48) for details.

- ⚠ When this parameter is displayed, the minilogue xd can receive SysEx microtuning messages. This will overwrite the scale contents you are currently editing, regardless of the numbers specified in the messages.

Button 12 (USER CLEAR)

User Scale 1...6

Initializes the microtunings that were edited in USER SCALE 1–6, button 10.

Press button 12 to select the microtuning to initialize. Turn the PROGRAM/VALUE knob until “Press WRITE” is indicated in the display, and then press the WRITE button.

User Octave 1...6

Initializes the microtunings that were edited in USER OCTAVE 1–6, button 11.

Press button 12 to select the microtuning to initialize. Turn the PROGRAM/VALUE knob until “Press WRITE” is indicated in the display, and then press the WRITE button.

Button 13 (USER DUMP)

User Scale 1...6

Transmits the microtunings that were edited in USER SCALE 1–6, button 10 as general SysEx messages.

Press button 13 to select the microtuning to transmit as SysEx. Turn the PROGRAM/VALUE knob until “Press WRITE” is indicated in the display, and then press the WRITE button.

User Octave 1...6

Transmits the microtunings that were edited in USER OCTAVE 1–6, button 11 as general SysEx messages.

Press button 13 to select the microtuning to transmit as SysEx. Turn the PROGRAM/VALUE knob until “Press WRITE” is indicated in the display, and then press the WRITE button.

Button 15 (ALL DUMP)

This button transmits the programs, live set and global SysEx data of this instrument to another minilogue xd, MIDI data filer, computer or other compatible device that is connected.

All Dump (USB)

Turn the PROGRAM/VALUE knob until “Press WRITE” is indicated in the display.

Press the WRITE button to transmit the MIDI data dump via the USB B port. The data will take around 20 seconds to transmit, and the message “Transmitting” will be shown in the display during this time.

- ⚠ If the USB cable is not connected, or if the MIDI IN port on the computer is not open, the data will not be transmitted.

All Dump (MIDI)

Turn the PROGRAM/VALUE knob until “Press WRITE” is indicated in the display.

Press the WRITE button to transmit the MIDI data dump via the MIDI OUT connector. The data will take around 3 minutes and 15 seconds to transmit, and the message “Transmitting” will be shown in the display during this time.

Other functions

Tuning

As with all analog instruments, the minilogue xd's circuitry can drift over time during performance due to changes in environment and temperature. The minilogue xd provides an **auto-tuning function** that automatically tunes the instrument's analog circuits on demand, to correct for any analog drift. Auto-tuning will be done when the minilogue xd is not producing a sound. As you continue to play the minilogue xd for a while right after you've turned it on, the pitch and tone may gradually drift. If the pitch drift becomes noticeable, use the steps below to tune the minilogue xd. This will manually bring the instrument back into tune.

Note: The internal temperature tends to change more right after the power is turned on, which may cause the instrument to go out of tune.

1. Press the REC button while holding down the SHIFT button.

Tuning will begin, and "Tuning..." will be shown in the display. The tuning will take about 15 seconds.

Tip: Press the REC button while holding down the SHIFT button again to cancel manual tuning, if you accidentally started it by mistake.

Note: During tuning, you will temporarily be unable to play the minilogue xd.

Microtuning

Microtuning is a feature that changes the pitch of the notes you play on the keyboard (which are normally tuned in equal temperament) to a different tuning.

The minilogue xd features preset microtunings, and lets you create your own microtunings.

Twelve microtunings are available to edit. Out of these, you can adjust the pitch on all of the notes on the keyboard for six microtunings called "user scales." The other six microtunings are called "user octaves," which let you change the tuning of each note within one octave, and that octave's tuning will be repeated across the keyboard.

The minilogue xd lets you select a different microtuning for each program. See "Microtuning" (p.36), PROGRAM EDIT mode for details.

Editing the microtunings

Here, we will edit USER SCALE 3.

1. Press the EDIT MODE button to enter GLOBAL EDIT mode.

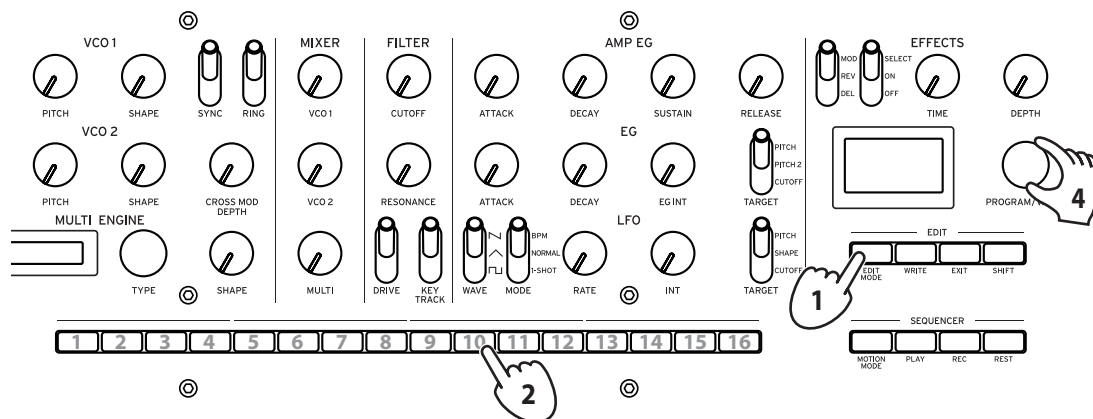

2. Press button 10 three times.

“USER SCALE 3” will be indicated in the display.



3. Play the note on the keyboard that you want to edit.

The note name will be indicated in the display.



While this screen is displayed, the minilogue xd will play use the microtuning you are currently editing.

Tip: You can play up to four notes at the same time to edit their tunings together.

4. Turn the PROGRAM/VALUE knob to set how many cents you want to detune the note compared to equal temperament tuning.



You can also turn the PROGRAM/VALUE knob while holding down the SHIFT button to have the note you are playing sound a different note.



When editing the **USER OCTAVE**, use step 2 above to display the USER OCTAVE screen by pressing button 11, and proceed from step 3.

Poly-chain

You can use this function to poly-chain this instrument to another minilogue xd, letting you play them together as an eight-voice synthesizer.

First of all, set the device on the master side to “Master,” and the device on the slave side to “Slave.”

Next, connect the MIDI OUT connector of the master side to the MIDI IN connector of the slave side using a MIDI cable.

Audio signals will be outputted through each device respectively. Use an external mixer or other device to adjust the signal volumes from the OUTPUT jacks of both instruments.

When playing the master side device, voices 5–8 will sound on the slave side, and you can play a total of eight voices. Refer to “Poly Chain” (p.45) for details.

Restoring the factory settings

You can restore the minilogue xd's preset programs and global settings to their original factory-set state at any time.

- 1. Begin with the minilogue xd turned Off.**
- 2. While holding down the WRITE button and the EXIT button, turn the minilogue xd On.**
"FACTORY RESET" will be indicated in the display.
- 3. Turn the PROGRAM/VALUE knob to select the items you wish to reset to the factory default settings.**
PRESET: Restores the preset programs (001–200) and the live set to their factory-set default settings.
⚠ If you do not want to erase the preset programs, press the WRITE button to save them to the user programs (201–500).
GLOBAL: Restores the GLOBAL settings to their factory-set default settings.
ALL: Restores the preset programs, user programs, the live set and GLOBAL settings to their factory-set default settings.
⚠ Use caution, as this will replace all data with the factory-set default settings (including the sounds saved to the user programs).
- 4. Press the WRITE button.**
The display will indicate the message "Are you sure?".
- 5. Turn the PROGRAM/VALUE knob to select "Yes", and press the WRITE button.**
The factory-set default data will be reloaded, and the minilogue xd will be restored to its factory default state.
⚠ Never turn off the minilogue xd while data is being loaded. Doing so might damage the internal data.

Shortcuts using the SHIFT button

By holding down the SHIFT button as you press other buttons, you can access a number of convenient features quickly and easily.

Function	SHIFT button +	
Load panel information (LOAD PNL)	Play mode PLAY button	Loads the state of the front panel switches and knobs into the selected program. Used to make the sound match the state of the controls on the front panel.
Tuning (TUNING)	Play mode REC button	You can retune the minilogue xd manually if the tuning seems to be drifting. Press the REC button while holding down the SHIFT button to cancel the operation, before performing any other operation.

Function	SHIFT button +	
Delete sequence data (SEQ CLR)	Play mode REST button	This deletes all sequence data (including notes and motion sequences) in the selected program. Press the REST button while holding down the SHIFT button once more changes to cancel the operation, before changing the sequence data and before performing any other operation.
MULTI ENGINE parameter settings (ALT)	Play mode When selecting "VPM" for the MULTI ENGINE using the NOISE/VPM/USR switch SHAPE knob (MULTI ENGINE)	This adjusts the modulator ratio.
	Play mode When selecting "Decim" for the MULTI ENGINE using the NOISE/VPM/USR switch set to "NOISE" SHAPE knob (MULTI ENGINE)	Adjusts the depth of the sample rate via keyboard tracking.
Selects the modulation effect sub-type (TYPE)	Play mode When selecting "MOD" using the DEL/REV/MOD switch (EFFECTS) OFF/ON/SELECT switch	Each time you flip the OFF/ON/SELECT switch to SELECT while holding the SHIFT button, a different effect sub-type is set.
Wet/dry settings for delay and reverb	Play mode When selecting "DEL" or "REV" using the DEL/REV/MOD switch DEPTH knob	Adjust the wet/dry mix for the delay or reverb.
Select a program	Play mode PROGRAM/VALUE knob	Selects a program either 10 programs before or after the currently selected program.
Select a favorite program	Play mode Buttons 1–16	Press a button from 1–16 while holding the SHIFT button to recall a favorite program previously registered to that button.
Register a favorite program	Play mode Buttons 1–16	Hold down a button from 1–16 while holding the SHIFT button to register the current program as a favorite program.
Pitch settings	Play mode (VCO1, VCO2) PITCH knob	Sets the pitch in semitones.
LFO waveform phase settings	Play mode INT knob (LFO)	This allows you to invert the phase of the LFO waveform.
Editing the micro-tunings	GLOBAL EDIT mode When selecting "USER SCALE" or "USER OCTAVE" PROGRAM/VALUE knob	Sets the pitch in units of 100 cents (semitones).

Using with other devices

Making connections with the SYNC IN/OUT jacks

The minilogue xd can be connected to other instruments such as the Korg volca series or DAW equipment that have a SYNC IN and OUT jack, allowing multiple devices to play back together in sync.

When controlling an external device from the minilogue xd

To synchronize the minilogue xd to other devices such as the volca, use a stereo mini cable to connect the SYNC OUT jack of this instrument to the SYNC IN jack of the external device.

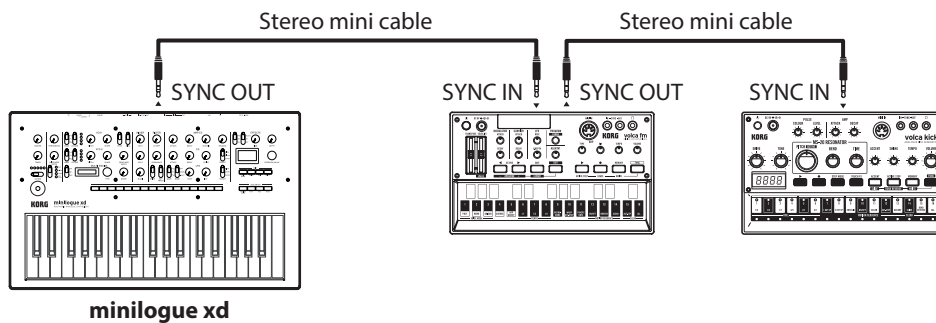

Use the same settings for “Sync Out Unit” (p.44) on this minilogue xd and “Sync In Unit” on the first external device to sync. Similarly, use the same settings for “Sync In Unit” on the second external device to sync.

See the owner’s manuals of each respective external device to synchronize.

Starting the sequencer on the minilogue xd will make the sequencer of the connected device synchronize with the minilogue xd.

Controlling the minilogue xd from an external device

In order to synchronize this instrument to external devices, use a stereo mini cable to connect the SYNC OUT jack of the external device to the SYNC IN jack of the minilogue xd.

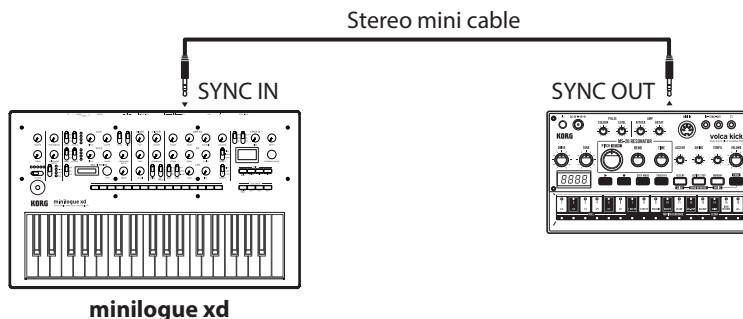

Use the same settings for “Sync In Unit” (p.44) on this minilogue xd and “Sync Out Unit” on the external device. Similarly, use the same settings for both the “Sync In Polarity” (p.44) and the “Sync Out Polarity” on the external device.

See the owner’s manuals of each respective external device to synchronize.

Starting the sequencer on the external device will make the sequencer of the minilogue xd synchronize with that device.

Making connections with the CV IN jacks

Connect these jacks to a external device that can output CV signals to control the minilogue xd. Connect the CV IN jack of the minilogue xd to the CV OUT jack of the external device using a monaural mini cable (or a stereo mini cable).

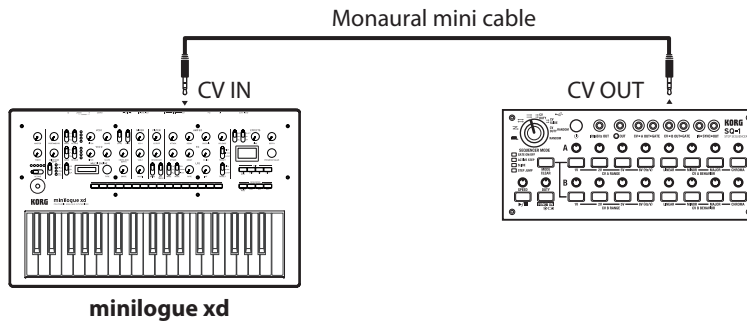

Configure the CV IN jack settings on the minilogue xd from “Button 5 (CV INPUT)” (p.36). See the owner’s manuals of each respective external device to synchronize.

Connecting to a MIDI device or a computer

MIDI stands for Musical Instrument Digital Interface, and is a worldwide standard for exchanging various types of musical data between electronic musical instruments and computers.

When MIDI cables are used to connect two or more MIDI devices, performance data can be exchanged between the devices, even if they were made by different manufacturers.

MIDI data can also be exchanged between the minilogue xd and your personal computer using a single USB cable. The minilogue xd lets you assign MIDI control change numbers (CC#) to the major parameters that affect the sound, and control these parameters from an external MIDI sequencer while you play the tone generator. You can also use the front panel knobs or buttons to transmit these control change messages, in order to control an external MIDI device.

You can also synchronize the minilogue xd’s tempo to the MIDI clock of an external MIDI sequencer or other device, so that the minilogue xd will play in time with the external device and with any changes you make.

Controlling an external MIDI tone generator from the minilogue xd

If you want to use the minilogue xd’s keyboard, controllers, and sequencer to play sounds on or control an external MIDI tone generator, connect the minilogue xd’s MIDI OUT connector to the external MIDI tone generator’s MIDI IN connector using a MIDI cable.

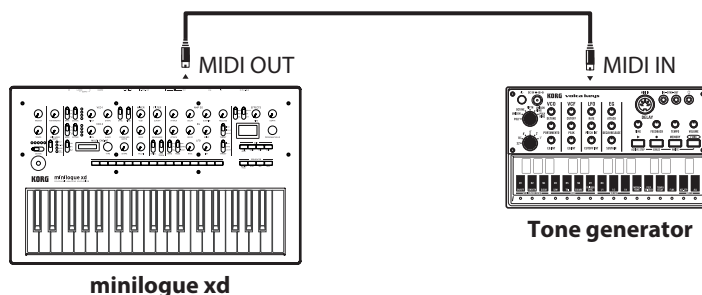

Controlling the minilogue xd from an external MIDI device

If you want to play or control the minilogue xd from another MIDI keyboard, sequencer, or other device, connect the MIDI OUT connector of the external MIDI device to the minilogue xd's MIDI IN connector with a MIDI cable.

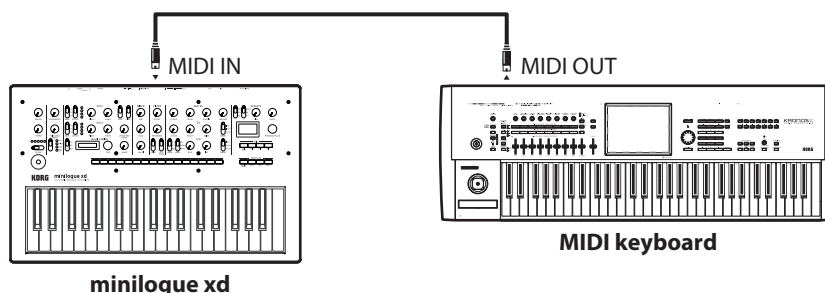

Connecting the minilogue xd to an external MIDI sequencer or computer

You can also play the minilogue xd's keyboard and record your performance on an external MIDI sequencer or computer (connected using the MIDI interface), and then play the minilogue xd while monitoring or playing back what you recorded. Also, you might want to use the minilogue xd as both an input device for playing notes and as a MIDI tone generator. In either case, you'll need to connect the MIDI OUT connector to the MIDI IN connector on both the minilogue xd and the external MIDI sequencer or computer.

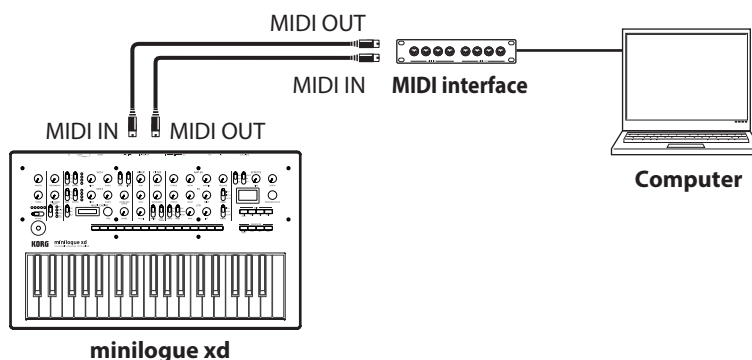

⚠ Some MIDI interface devices may be unable to transmit or receive MIDI SysEx messages to or from the minilogue xd.

Tip: It's convenient to use the USB port when connecting the minilogue xd to a computer.

Connecting the minilogue xd to a computer via USB

In order to use a USB connection, you'll need to install the Korg USB-MIDI driver on your computer. Download the "Korg USB-MIDI driver" from the Korg website, and install it as described in the accompanying documentation.

⚠ If either the MIDI connection or the USB connection is not working properly, check the settings in "MIDI Route" (p.44).

MIDI-related settings (after making connections)

Setting the MIDI channel

In order to exchange data with a connected external MIDI device, you must set the minilogue xd's MIDI channel to match the MIDI channel of the external MIDI device. Refer to "MIDI Ch" (p.44) to set the minilogue xd's MIDI channel.

Tip: When synchronizing to an external MIDI device, refer to that device's owner's manual.

Configuring the MIDI "LOCAL" setting when connected to an external MIDI sequencer or computer

The Echo Back setting of your external MIDI sequencer or computer system allows the MIDI notes and other messages being played by the minilogue xd to be instantly passed along to any other MIDI equipment, including synthesizers, tone generators. However, this same Echo Back function can cause the minilogue xd to double trigger: once when you play the note, and a second time as the external MIDI sequencer or computer system sends the note back to the minilogue xd. To prevent this from happening, you can simply turn off the "Local SW" (p.42) in GLOBAL EDIT mode on the minilogue xd.

MIDI filter settings

Use these settings to configure whether program changes, control changes and pitch bend messages will be transmitted and received.

Use "Button 7 (GLOBAL 5)" (p.45) to make these detailed settings.

Synchronizing your performance with the sequencer

Use "Clock Source" (p.45) to set whether the minilogue xd will be the master (the device controlling the synchronization) or the slave (the device being controlled) when the sequencer is playing.

When synchronizing to an external MIDI device, refer to that device's owner's manual.

Using the minilogue xd as the master to slave external MIDI devices

Connect the MIDI OUT connector of the minilogue xd to the MIDI IN connector of your external MIDI device(s).

Set the "Clock Source" (p.45) on the minilogue xd to "Internal". Configure the external MIDI device to receive clock data via MIDI. The minilogue xd will act as the master, and the tempo that is set using the TEMPO knob on the minilogue xd will be sent as MIDI timing clock data to operate the external MIDI device (sequencers, rhythm machines, and so on).

Slaving the minilogue xd clock to an external MIDI device (master)

Connect the MIDI IN connector of the minilogue xd to the MIDI OUT connector of your external MIDI device.

Set the "Clock Source" (p.45) of the minilogue xd to "Auto (MIDI)," and configure the external MIDI device to transmit MIDI clock data.

The minilogue xd will automatically act as the slave whenever a MIDI timing clock is received, and will be driven by the tempo of the external MIDI device (sequencers, rhythm machines, and so on).

Note: Even if you set the "Clock Source" on the minilogue xd to "Auto (USB)" or "Auto (MIDI)," the minilogue xd will operate in internal MIDI clock mode, unless a clock is received from an external device.

Data list

Effects list

EFFECT TYPE: DELAY	SUB TYPE	
Delay	Stereo	A stereo delay with an expansive left-right field.
	Mono	A straight monaural delay.
	Ping Pong	A ping-pong delay that bounces back and forth from left to right.
	Hipass	A delay with a high-pass filter on which the low frequency band fades out.
	Tape	Simulates a tape echo.
	One Tap	A delay without feedback, on which the delay sounds only once.
	Stereo BPM	A stereo delay on which the delay time is synced to the TEMPO button settings.
	Mono BPM	A monaural delay on which the delay time is synced to the TEMPO button settings.
	Ping BPM	A ping-pong delay on which the delay time is synced to the TEMPO button settings.
	Hipass BPM	A high-pass delay on which the delay time is synced to the TEMPO button settings.
	Tape BPM	A tape echo on which the delay time is synced to the TEMPO button settings.
	Doubling	A short delay with a doubling effect.
EFFECT TYPE: REVERB	SUB TYPE	
Reverb	Hall	A hall-type reverb that simulates the reverberations of a mid-size concert hall or ensemble hall.
	Smooth	A clear reverb with a sustaining high end.
	Arena	A reverb that evokes the feeling of a spacious area like a stadium.
	Plate	A warm-sounding (wet) plate reverb.
	Room	A reverb that simulates the reverberations of a small room.
	Early Ref	A reverb that emphasizes the brighter initial reflections than the lingering echoes.
	Space	An unstable reverb reminiscent of being in space.
	Riser	A shimmering reverb that echoes one octave higher.
	Submarine	A deep reverb that echoes one octave lower.
	Horror	A reverb with a highly unstable tonal quality.

EFFECT TYPE: MOD	SUB TYPE	
CHORUS	Stereo	A stereo chorus effect that varies the input signal to create a thicker or warmer sound.
	Light	A chorus effect with lighter modulation than the stereo type.
	Deep	A chorus effect with heavier modulation than the stereo type.
	Triphase	An effect with three choruses, each with different LFO phases.
	Harmonic	A chorus with slightly emphasized overtones.
	Mono	A monaural chorus.
	Feedback	A chorus that uses feedback to create an effect similar to a short delay.
	Vibrato	Produces a vibrato (wavering) effect.
ENSEMBLE	Stereo	An LFO-driven effect with an intricate wavering sound. Produces a spatially deep and expansive ensemble effect.
	Light	An ensemble effect with lighter vibrato than the stereo type.
	Mono	A monaural ensemble effect.
PHASER	Stereo	Alters the phase of the sound to give the sound a swelling effect.
	Fast	A phaser effect that swells faster than the stereo type.
	Orange	An effect that models a popular analog phaser in an orange box.
	Small	An effect that models the classic New York phaser sound from the 1970s.
	Small Reso	A small-type phaser sound with strong peak components.
	Black	An effect modeled after the phaser sounds from Denmark with a wide dynamic range.
	Formant	A phaser derived from the sound of the human voice.
	Twinkle	A phaser that creates a twinkling (sparkly) sound.
FLANGER	Stereo	An effect that creates a thick swelling sound and a sense of motion in pitch.
	Light	A flanger with a thinner effect than the stereo type.
	Mono	A monaural flanger.
	High Sweep	A flanger that sweeps through the high-frequency bands.
	Mid Sweep	A flanger that sweeps through the mid-frequency bands.
	Pan Sweep	A flanger that pans from left to right.
	Mono Sweep	A monaural sweeping flanger.
	Triphase	A flanger featuring the effect of three LFOs.
(USER)	This effect is not installed at factory-set default, so it cannot be selected. Upload a user effect in order to select. See the "logue SDK" (www.korg.com) for details.	

Program list

No	Program Name	Category	Voice Mode	Author
1	Replicant xd	Pad	POLY	Luke Edwards
2	TyoCityLoop	Poly Synth	POLY	Tomohiro Nakamura
3	Sharp Fifth	Poly Synth	POLY	Artemiy Pavlov
4	Quarra	Poly Synth	POLY	Tomohiro Nakamura
5	Terror Key	Poly Synth	POLY	KORG Inc.
6	PWM Cloud	Poly Synth	POLY	Artemiy Pavlov
7	Pump SAW	Poly Synth	POLY	Tomohiro Nakamura
8	Orchestra xD	Poly Synth	POLY	Tomohiro Nakamura
9	MirroredBass	Bass	UNISON	KORG Inc.
10	Mr. Squelch	Bass	CHORD	Artemiy Pavlov
11	MetalFnkLead	Lead	CHORD	Tomohiro Nakamura
12	Space Clavi	Poly Synth	POLY	Tomohiro Nakamura
13	VelocityStab	Chord	CHORD	KORG Inc.
14	Bassblaster	Bass	CHORD	KORG Inc.
15	Digital Rush	Arp	ARP	KORG Inc.
16	OnTheLevel	Poly Synth	POLY	Ian Bradshaw
17	CheeseRoyale	Poly Synth	POLY	Taylor McFerrin
18	BabeWave	Poly Synth	POLY	Nick Kwas
19	Pluck VPM	Poly Synth	POLY	Tomohiro Nakamura
20	Pulsating80s	Poly Synth	POLY	Luke Edwards
21	Fifth Kiss	Poly Synth	POLY	Artemiy Pavlov
22	Warm Dtn	Poly Synth	POLY	Tomohiro Nakamura
23	Funky Stab	Poly Synth	POLY	Luke Edwards
24	Harp xd	Poly Synth	POLY	Tomohiro Nakamura
25	Future Pulse	Poly Synth	POLY	Luke Edwards
26	Atk&Rel	Poly Synth	POLY	Tomohiro Nakamura
27	Prolly800mk2	Poly Synth	POLY	Nick Kwas
28	Kawaii Chord	Poly Synth	POLY	Nick Kwas
29	Creep Lights	Poly Synth	POLY	Tomohiro Nakamura
30	Trill Synth	Poly Synth	POLY	Tomohiro Nakamura
31	LapisLazuli	Poly Synth	POLY	Tomohiro Nakamura
32	Claymate	Poly Synth	POLY	Dorian Concept
33	DownStair	Poly Synth	POLY	Tomohiro Nakamura
34	FallingPluck	Poly Synth	POLY	Dorian Concept
35	Rainchild	Poly Synth	POLY	Tomohiro Nakamura
36	Tape*Sine	Poly Synth	POLY	Dorian Concept
37	Mini Moon	Poly Synth	POLY	Nick Kwas
38	Petrichor	Poly Synth	POLY	Taylor McFerrin
39	LoFi Strings	Poly Synth	POLY	Tomohiro Nakamura
40	Signal Key	Poly Synth	POLY	KORG Inc.
41	Organ xd	Poly Synth	POLY	Tomohiro Nakamura
42	Organic Keys	Poly Synth	POLY	Taylor McFerrin
43	K.ORG	Poly Synth	POLY	Artemiy Pavlov
44	Soapy EP	Poly Synth	POLY	Artemiy Pavlov
45	Logue Lady	Poly Synth	POLY	Nick Kwas
46	90's EPiano	Poly Synth	POLY	Tomohiro Nakamura
47	XD Seven	Poly Synth	POLY	Artemiy Pavlov
48	Roadz Bell	Poly Synth	POLY	Ian Bradshaw
49	Glocken xd	Poly Synth	POLY	Tomohiro Nakamura
50	Smart Bell	Poly Synth	POLY	KORG Inc.

No	Program Name	Category	Voice Mode	Author
51	FantaBell	Poly Synth	POLY	Tomohiro Nakamura
52	GateSteps	Poly Synth	POLY	Taylor McFerrin
53	Gate 4AM	Poly Synth	POLY	Taylor McFerrin
54	1982theme	Poly Synth	POLY	Tomohiro Nakamura
55	LukeWarm Pad	Pad	POLY	Luke Edwards
56	RiseToPower	Pad	POLY	Luke Edwards
57	Eyes Of Owl	Pad	POLY	Tomohiro Nakamura
58	Nowhere Pad	Pad	POLY	Tomohiro Nakamura
59	WaveSeq Pad	Pad	POLY	Tomohiro Nakamura
60	GlasssinePad	Pad	POLY	Tomohiro Nakamura
61	Angelic Vox	Pad	POLY	Artemiy Pavlov
62	Plastic Pad	Pad	POLY	Artemiy Pavlov
63	Haunted Pad	Pad	POLY	Artemiy Pavlov
64	Gaia Dawn	Pad	POLY	Tomohiro Nakamura
65	Swollen Pad	Pad	POLY	Dorian Concept
66	Xtra Fat	Pad	POLY	Artemiy Pavlov
67	Sacred Wall	Pad	POLY	KORG Inc.
68	Ring PWM	Pad	POLY	Artemiy Pavlov
69	BrightStrngs	Pad	POLY	Artemiy Pavlov
70	Square Drone	Pad	POLY	Artemiy Pavlov
71	Boombastic	Bass	CHORD	Artemiy Pavlov
72	Dirty Trappn	Bass	UNISON	Nick Kwas
73	M.G.Bass	Bass	CHORD	KORG Inc.
74	Octava Bass	Bass	CHORD	Taylor McFerrin
75	PWM Bass	Bass	CHORD	Artemiy Pavlov
76	Cutie Bass	Bass	CHORD	KORG Inc.
77	Anchor Bass	Bass	CHORD	KORG Inc.
78	TriKO Bass	Bass	CHORD	Tomohiro Nakamura
79	Pluck Bass	Bass	CHORD	Artemiy Pavlov
80	Sharp Teeth	Bass	CHORD	Artemiy Pavlov
81	Hypno Acid	Bass	CHORD	Artemiy Pavlov
82	Spike Bass	Bass	UNISON	KORG Inc.
83	Pure Vintage	Bass	CHORD	Artemiy Pavlov
84	Tronic Bass	Bass	CHORD	Artemiy Pavlov
85	Multi Bass	Bass	CHORD	Artemiy Pavlov
86	Thick Bass	Bass	UNISON	Luke Edwards
87	FM Dubz	Bass	UNISON	Luke Edwards
88	Brawl Bass	Bass	CHORD	KORG Inc.
89	Wire Bass	Bass	CHORD	Tomohiro Nakamura
90	ScreaFM Bass	Bass	CHORD	Tomohiro Nakamura
91	Dirty Pulse	Bass	CHORD	Artemiy Pavlov
92	Crude Pulse	Bass	CHORD	Artemiy Pavlov
93	Flat Lead	Lead	CHORD	KORG Inc.
94	Cheese Lead	Lead	CHORD	Tomohiro Nakamura
95	Classic Lead	Lead	CHORD	KORG Inc.
96	Waard Lead	Lead	CHORD	KORG Inc.
97	OrientalLead	Lead	CHORD	KORG Inc.
98	RingSoloLead	Lead	CHORD	KORG Inc.
99	Rave Synth	Lead	UNISON	Artemiy Pavlov
100	Detuned Saw	Lead	UNISON	Luke Edwards

No	Program Name	Category	Voice Mode	Author
101	Pressure	Lead	POLY	KORG Inc.
102	Vreeeew	Lead	POLY	Nick Kwas
103	EvilSyncLead	Lead	UNISON	Tomohiro Nakamura
104	OvrdriveLead	Lead	UNISON	KORG Inc.
105	Hybrid	Lead	POLY	Artemiy Pavlov
106	Hoover Cloud	Lead	UNISON	Artemiy Pavlov
107	Dense Lead	Lead	CHORD	Taylor McFerrin
108	The Blob	Lead	CHORD	Dorian Concept
109	WaveringLead	Lead	UNISON	Luke Edwards
110	Message From	Lead	CHORD	KORG Inc.
111	Joystick!	Lead	CHORD	Tomohiro Nakamura
112	#brew time	Arp	ARP	Luke Edwards
113	Duality	Arp	ARP	Artemiy Pavlov
114	Cluster 5th	Arp	ARP	Dorian Concept
115	Innerstellar	Arp	ARP	Tomohiro Nakamura
116	xdBassRepeat	Arp	ARP	Luke Edwards
117	Cloud Level	Arp	ARP	Nick Kwas
118	Beautyvolver	Arp	ARP	Nick Kwas
119	Sparkles	Arp	ARP	Artemiy Pavlov
120	Trance Vibes	Arp	ARP	Artemiy Pavlov
121	Warpeggio	Arp	ARP	Dorian Concept
122	LetGo Arp	Arp	ARP	Dorian Concept
123	Fat Plucks	Arp	ARP	KORG Inc.
124	Alarm&Bottle	Arp	POLY	KORG Inc.
125	Deep Flavor	Chord	CHORD	KORG Inc.
126	Piano Chord	Chord	CHORD	Artemiy Pavlov
127	Gxyexp Stab	Chord	CHORD	KORG Inc.
128	Lush m7	Chord	CHORD	Artemiy Pavlov
129	SpiralNebula	Chord	CHORD	KORG Inc.
130	Third Code	Chord	CHORD	Taylor McFerrin
131	Sirens	SFX	POLY	Artemiy Pavlov
132	Halo Pad	SFX	POLY	Taylor McFerrin
133	Antidote	SFX	CHORD	Taylor McFerrin
134	Starship	SFX	POLY	Artemiy Pavlov
135	Space Acid	SFX	CHORD	Artemiy Pavlov
136	Late Riser	SFX	POLY	Taylor McFerrin
137	Doppler Pad	SFX	POLY	Taylor McFerrin
138	Disco Callin	SFX	CHORD	KORG Inc.
139	RuinHitChart	SFX	UNISON	Tomohiro Nakamura
140	Broken Toy	SFX	POLY	Tomohiro Nakamura
141	PTN Techno1	Drum	POLY	Tomohiro Nakamura
142	PTN Techno2	Drum	CHORD	Tomohiro Nakamura
143	PTN DubTch	Drum	POLY	Tomohiro Nakamura
144	PTN Acieeed?	Drum	CHORD	Tomohiro Nakamura
145	PTN Mutant	Drum	POLY	Tomohiro Nakamura
146	PTN Mellow	Drum	POLY	Tomohiro Nakamura
147	Game On!	Drum	POLY	Tomohiro Nakamura
148	16bt Bass	Drum	CHORD	Tomohiro Nakamura
149	VPM Plant	Drum	UNISON	Tomohiro Nakamura
150	BDSDHHTOM	Drum	POLY	Tomohiro Nakamura

No	Program Name	Category	Voice Mode	Author
151	TPL BasicSaw	Template	POLY	KORG Inc.
152	TPL BasicTri	Template	POLY	KORG Inc.
153	TPL BasicSqr	Template	POLY	KORG Inc.
154	TPL BasicSin	Template	POLY	KORG Inc.
155	TPL LayerOct	Template	POLY	KORG Inc.
156	TPL Layer5th	Template	POLY	KORG Inc.
157	TPL 3sawPoly	Template	POLY	KORG Inc.
158	TPL 4sawDuo	Template	POLY	KORG Inc.
159	TPL 8sawMono	Template	UNISON	KORG Inc.
160	TPL SyncVCO2	Template	POLY	KORG Inc.
161	TPL RingVCO2	Template	POLY	KORG Inc.
162	TPL XmodVCO2	Template	POLY	KORG Inc.
163	TPL ResoVelo	Template	POLY	KORG Inc.
164	TPL ShortTom	Template	POLY	KORG Inc.
165	TPL Sweeping	Template	POLY	KORG Inc.
166	TPL EG+1shot	Template	POLY	KORG Inc.
167	TPL PulseWM	Template	POLY	KORG Inc.
168	TPL VPMmod	Template	POLY	KORG Inc.
169	TPL TrillLFO	Template	POLY	KORG Inc.
170	TPL PumpSaw	Template	POLY	KORG Inc.
171	TPL ChordHit	Template	CHORD	KORG Inc.
172	TPL RandArp	Template	ARP	KORG Inc.
173	TPL Repeater	Template	ARP	KORG Inc.
174	TPL PingPong	Template	POLY	KORG Inc.
175	TPL Downpour	Template	POLY	KORG Inc.
176	TPL 100%Wet	Template	POLY	KORG Inc.
177	TPL Doubling	Template	POLY	KORG Inc.
178	TPL Parroted	Template	POLY	KORG Inc.
179	TPL PumpNois	Template	CHORD	KORG Inc.
180	TPL DownSmpl	Template	CHORD	KORG Inc.
181	TPL ThruVCF	Template	POLY	KORG Inc.
182	TPL 2Sines	Template	POLY	KORG Inc.
183	TPL Reversed	Template	POLY	KORG Inc.
184	TPL LongSeq	Template	POLY	KORG Inc.
185	TPL Strings	Template	POLY	KORG Inc.
186	TPL Brass	Template	POLY	KORG Inc.
187	TPL Organ	Template	POLY	KORG Inc.
188	TPL WahClav	Template	POLY	KORG Inc.
189	TPL A.EPiano	Template	POLY	KORG Inc.
190	TPL D.EPiano	Template	POLY	KORG Inc.
191	TPL A.Bell	Template	POLY	KORG Inc.
192	TPL D.Bell	Template	POLY	KORG Inc.
193	TPL SubBass	Template	UNISON	KORG Inc.
194	TPL LofiSine	Template	CHORD	KORG Inc.
195	TPL MonoDriv	Template	CHORD	KORG Inc.
196	TPL RoarVPM	Template	CHORD	KORG Inc.
197	TPL Talkie	Template	POLY	KORG Inc.
198	TPL Kick	Template	POLY	KORG Inc.
199	TPL Snare	Template	POLY	KORG Inc.
200	TPL Hats	Template	CHORD	KORG Inc.

No	Program Name	Category	Voice Mode	Author
201 ⋮ 500	(Init Program)			

All Programs were made by Artemiy Pavlov, Dorian Concept, Ian Bradshaw, Luke Edwards, Nick Kwas, Taylor McFerrin, Tomohiro Nakamura and KORG Inc.

For more information about the authors please visit:

Artemiy Pavlov

<https://www.sinevibes.com/>

Dorian Concept

<https://www.dorianconcept.com/>

Taylor McFerrin

<https://www.taylormcferrin.com/>

Tomohiro Nakamura (aka ghostradioshow)

<http://www.youtube.com/user/ghostradioshow>

Specifications

Keyboard (minilogue xd)	37 keys (slim keyboard, velocity sensitive)
Sound generator	Analog sound generator + Multi digital sound generator
Maximum polyphony	4 voices
Programs	500 (200 preset programs and 300 user programs as the factory-set default) Each program includes Voice mode settings. Programs can be set as favorites.
Voice mode	4 (ARP/LATCH, CHORD, UNISON, POLY) The VOICE MODE DEPTH knob can be used to change parameters that differ for each mode.
Sequencer	16-step polyphonic sequencer.
Sound generating system	2 VCO (square wave, triangle wave, sawtooth wave), MULTI ENGINE (noise generator, VPM oscillator, user oscillator), 1 VCF, 2 EG, 1 LFO, 1 VCA
Effects	DELAY, REVERB, MOD (CHORUS, ENSEMBLE, PHASER, FLANGER, USER)
Display	Main: Organic EL (electro-luminescence) display with oscilloscope function MULTI ENGINE section: 7-segment LED, 6 characters x 1 line
Input/output jacks	Headphones jack (6.3mm stereo phone jack) OUTPUT L/MONO and R jacks (6.3mm monaural phone jack, unbalanced) DAMPER jack (half-damper not supported) SYNC IN jack (3.5 mm stereo mini-phone jack, 20V maximum input level) SYNC OUT jack (3.5 mm stereo mini-phone jack, 5V output level) CV IN 1 and 2 jacks (3.5 mm monaural mini-phone jack; input voltage: -5V to 5V in modulation mode, -3V to 5V in CV/gate mode) MIDI IN and OUT connectors USB B port
Power	AC adapter (DC 9V, )
Power consumption	8 W
Dimensions (W x D x H)	minilogue xd: 500 × 300 × 85 mm / 19.69" × 11.81" × 3.35" minilogue xd module: 500 × 179 × 85 mm / 19.69" × 7.05" × 3.35"
Weight	minilogue xd: 2.8 kg / 6.17 lbs. minilogue xd module: 2.6 kg / 5.73 lbs.
Included items	AC adapter, Precautions, Quick Start Guide
Accessories (sold separately)	DS-1H damper pedal PS-1 pedal switch PS-3 pedal switch

* Specifications and appearance are subject to change without notice for improvement.

* Since the instrument uses natural wood, there will be individual differences in the wood grain, surface texture and color.

* All product names and company names are the trademarks or registered trademarks of their respective owners.

MIDI Implementation Chart

Function...		Transmitted	Recognized	Remarks
Basic Channel	Default	1-16	1-16	Memorized
	Change	1-16	1-16	
Mode	Default	X	3	
	Messages	X	X	
	Altered	*****		
Note Number	True Voice	0-127	0-127	
		*****	0-127	
Velocity	Note On	O 9n, V=1-127	O 9n, V=1-127	
	Note Off	X 8n, V=64	X	
After Touch	Key's	X	X	
	Channel	X	X	
Pitch Bend		O	O	*1
Control Change	0, 32	O	O	BANK SELECT(MSB, LSB) *2
	5	O	O	PORTAMENTO *2
	6	O	O	Data Entry (MSB) *2
	7, 11	X	O	Volume / Expression *2
	27, 52	O	O	VOICE MODE DEPTH/VOICE MODE TYPE *2
	50, 48, 34, 36	O	O	VCO1 WAVE/OCTAVE/PITCH/SHAPE *2
	51, 49, 35, 37	O	O	VCO2 WAVE/OCTAVE/PITCH/SHAPE *2
	53, 103, 54, 104	O	O	MULTI TYPE/SUB TYPE/SHAPE/SHIFT SHAPE *2
	39, 40, 33	O	O	MIXER VCO1/VCO2/MULTI *2
	43, 44	O	O	CUTOFF/RESONANCE *2
	84, 83	O	O	CUTOFF DRIVE/KEYTRACK *2
	16, 17, 18, 19	O	O	AMP EG A/D/S/R *2
	20, 21, 22, 23	O	O	EG A/D, EG INT, EG TARGET *2
	57, 58, 24	O	O	LFO WAVE/MODE/RATE *2
	26, 56	O	O	LFO INT/TARGET *2
	88, 96, 28, 29	O	O	MOD FX TYPE/SUB TYPE/TIME/DEPTH *2
	89, 105, 112, 107	O	O	DELAY TYPE/TIME/DEPTH/DRY WET *2
90, 114, 115, 110	O	O	REVERB TYPE/TIME/DEPTH/DRY WET *2	
80, 81, 41	O	O	SYNC/RING/CROSS MOD DEPTH *2	
92, 94, 95	O	O	MOD FX ON-OFF/DELAY ON-OFF/REVERB ON-OFF *2	
98, 99	O	O	NRPN (LSB, MSB) *2	
64	O	O	Damper *2	
120, 121	X	O	All sound off, Reset all Controllers *2	
Program Change	True Number	O 0-99	O 0-99	*3
		*****	0-99	
System Exclusive		O	O	*4
System Common	Song Position	X	X	
	Song Select	X	X	
	Tune Request	X	X	
System Real Time	Clock	O	O	*5
	Commands	O	O	*6
Aux Messages	Local On/Off	X	O	
	All Notes Off	X	O (123-127)	
	Active Sense	O	O	
	System Reset	X	X	

Notes

- *1: When the Global setting is "MIDI Rx Pitch Bend=On", the minilogue xd/minilogue xd module will receive signals; and when the Global setting is "MIDI Tx Pitch Bend=On", the minilogue xd/minilogue xd module will transmit signals.
- *2: When the Global setting is "MIDI Rx CC=ON", the minilogue xd/minilogue xd module will receive signals; and the when Global setting is "MIDI Tx CC=On", the minilogue xd/minilogue xd module will transmit signals.
- *3: When the Global setting is "MIDI Rx Pirog Chg=ON", the minilogue xd/minilogue xd module will receive signals; and when the Global setting is "MIDI Tx Prog Chg=On", the minilogue xd/minilogue xd module will transmit signals.
- *4: In addition to Korg exclusive messages, Inquiry is supported.
- *5: When the Global setting is "Clock Source=Internal", the minilogue xd/minilogue xd module will not receive signals. The minilogue xd/minilogue xd module will receive signals when set to "Auto (MIDI)" or "Auto (USB)".
- *6: When the Global setting is "En Rx Transport=ON", the xd/minilogue xd module will transmit signals.

Mode 1: Omni On, Poly
 Mode 3: Omni Off, Poly

Mode 2: Omni On, Mono
 Mode 4: Omni Off, Mono

O: Yes
 X: No

Consult your local Korg distributor for more information on MIDI implementation.

KORG INC.

4015-2 Yanokuchi, Inagi-City, Tokyo 206-0812 JAPAN
© 2019 KORG INC.

www.korg.com
Published 5/2019