

HEXMIX SYSTEM USER MANUAL

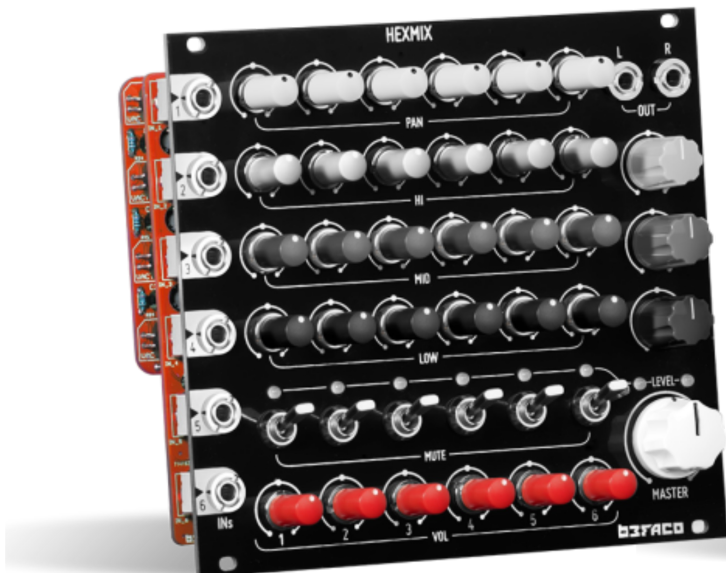

B3FACO

INTRODUCTION | SIX CHANNEL PERFORMANCE MIXER DESIGNED FOR EURORACK

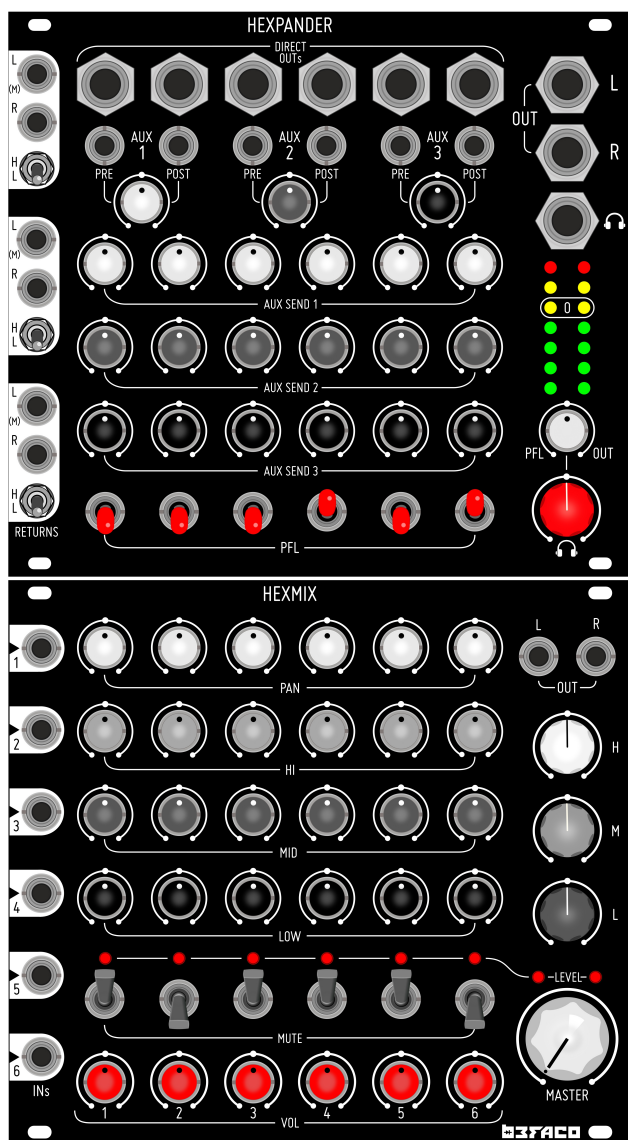

Hexmix System is a six channel performance mixer specially designed for Eurorack.

The system has two separate modules, the core of the mixer: Hexmix that has six channels with three band EQ, mute, pan and EQ section on the master, and Hexpander that add three auxiliary sends per channel, PFL, individual outs and balanced output.

The mixer has a strong inspiration in classical DJ mixers, providing sharp EQ's for enhanced performance, auxiliary send for effects and individual outputs to record your performance per channel.

The unique Mute Section is a powerful tool for performances, providing a momentary mute function controlled by vactrols and adding a smooth release to the signal decay.

The system is designed to be placed in 6U, instead of the traditional 3U paradigm in Eurorack. So we will have every feature for each channel vertically as a conventional tabletop mixing deck.

Hexmix can be used by itself, although in this manual we will be covering both Hexmix and Hexpander as a complete mixing system.

In addition, Hexmix system is designed to work with Hexmix VCA module, so every output of the VCA will be linked to each input of Hexmix system.

For further information about Hexmix VCA and the rest of our modules visit our website befaco.org.

HEXMIX

Let's take a look inside the Hexmix Module.

There are three connectors in Hexmix, please read carefully before connecting the module in your rack.

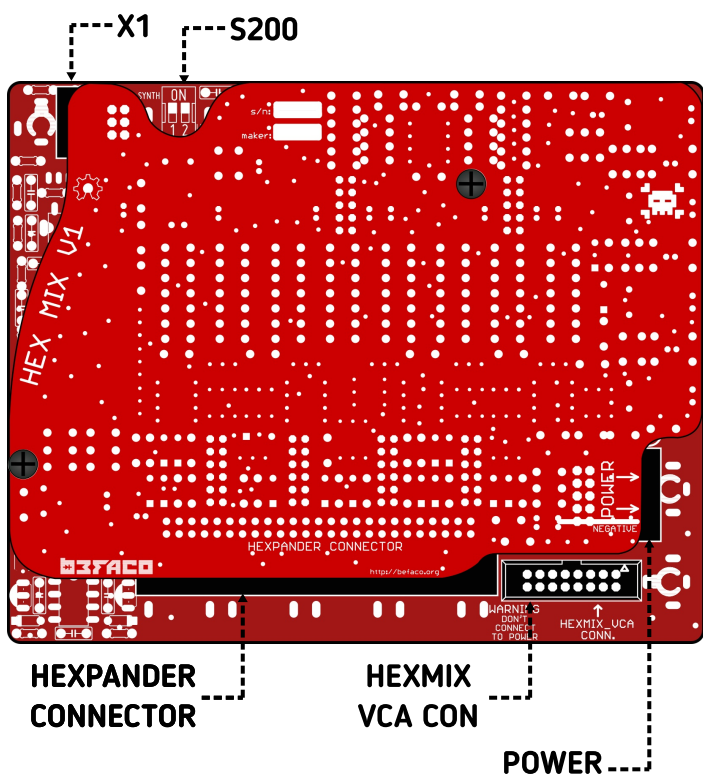

1. Power
Eurorack power connector. Please mind polarity so red line matches the arrow in the connector and white line in PCB. Used to power up the module.
2. Hexpander Connector
Expansion port, only used if you are using Hexpander as well. Cable is included with Hexpander module.
3. Hexmix_VCA Con
Communication port. **Do not connect power here!** Only used if you also have an Hexmix VCA.
4. X1
Expansion port. Not used... for now.
5. S200
Output level selector. You can either configure your master output to be Modular Level (5Vp) or Line Level.

POWERING THE MODULE | PREVIOUS CONSIDERATIONS

1. **Disconnect your cabinet from the mains.**
2. Take a look at your module box. You will find two types of cables:
 - 1x 10x16 channels - **Power Cable**
 - 1x 16x16 channels - **VCA Con Cable**
3. **Connect power cable into POWER connector.** Find the connector marked in the silkscreen.
4. **Triple check the power cord polarity.** The coloured line on the cable (pin number one) is the -12V rail and must match white line in PCB.
5. If you plug the power cable **backwards or in the VCA Con Port** you might burn it out and unfortunately this is not covered by the warranty.
6. If you have any questions about this product please send them to: befacosynth@gmail.com

MODULE REFERENCE | FRONT PANEL CONTROLS

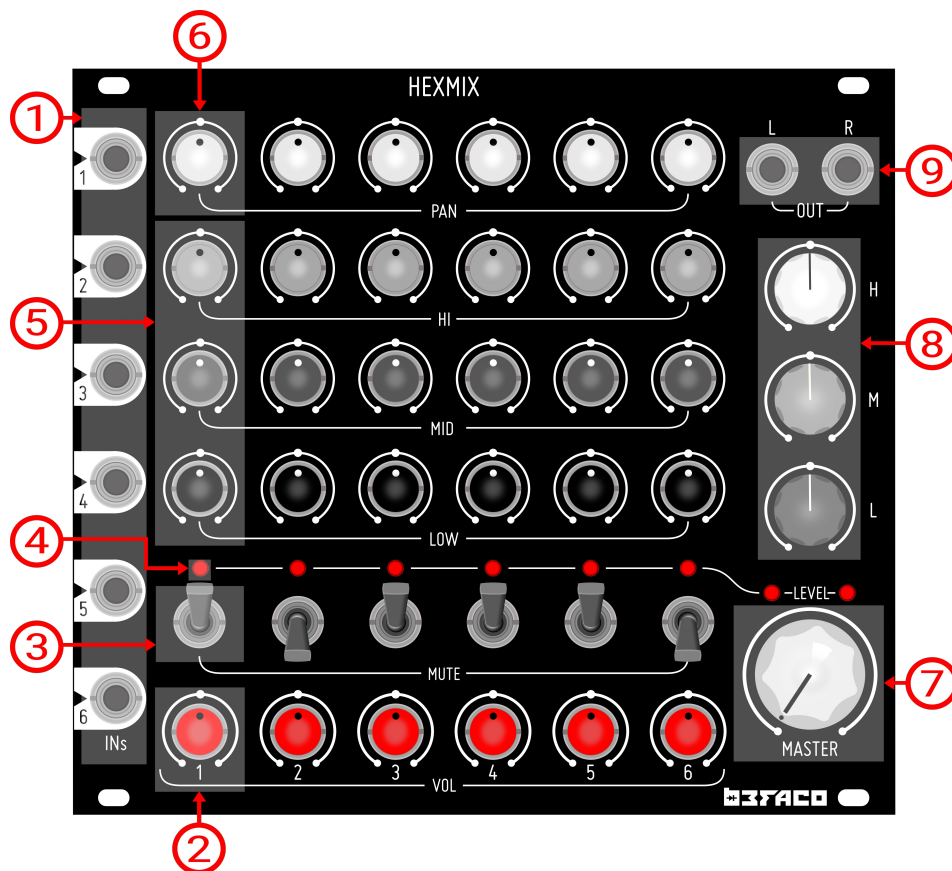

1. Channel Inputs

Main Input of each channel.

2. Volume Control

Volume control of each channel.

3. Mute Switch

Three position switch with momentary and latch function for channel mute.

4. Channel Led

Shows the signal level of each channel. Green indicate presence of signal and red indicate signal clipping.

5. Channel EQ

Volume controls for low, mid and high range of the three band channel EQ.

6. Channel Pan

Control of each channel panorama.

7. Master Level

Volume control of Master channel.

8. Master EQ

Volume controls for low, mid and high range of the three band Master EQ.

9. Master Output

Master stereo output of six channels sum.

EXTENDED REFERENCE | THE CHANNEL STRIP

The signal passes through various process on channel before being sent to the master section. All of this process are located and controlled at each Channel Strip.

The Channel Strip is divided in four basic sections, that will go in the following order: EQ, volume, Mute and Pan.

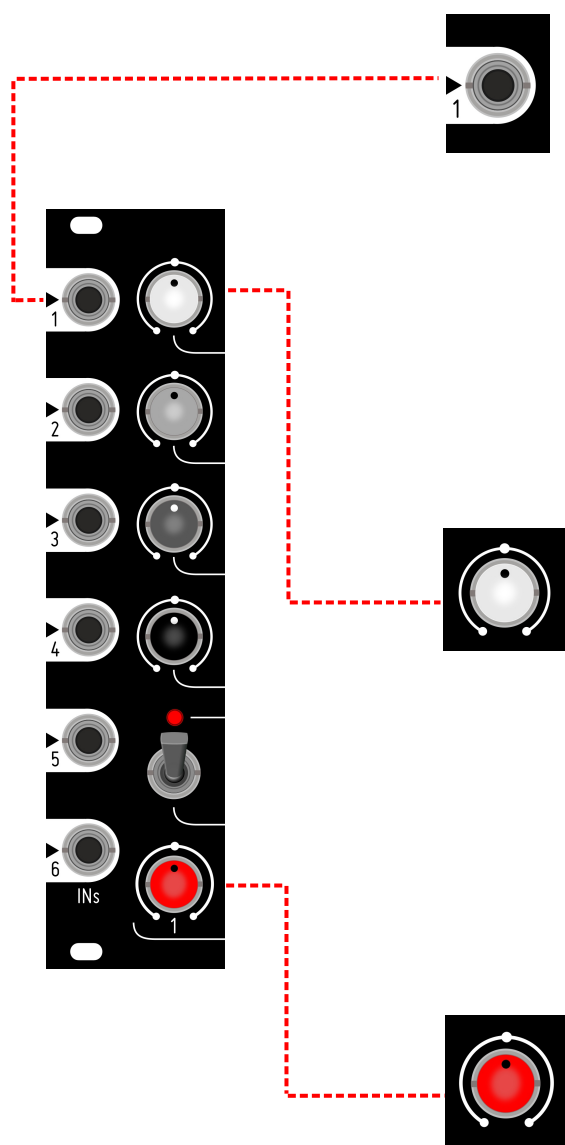

Inputs

Inputs for every channel are located at left side of Hexmix. Each jack is normalized to VCA Expander connection, so if you have a Hexmix VCA connected via the expansion port, you will have the output of each VCA to every input. connecting a jack in any input will disconnect whatever is coming from VCA.

Pan

Pan (or panning) is the spread of a monoaural signal in a stereo sound field (L-R). At one extreme, the sounds appears in only one channel. In the middle, the sound is decreased in that channel by 3dB, and the other channel is brought up to the same level, so that the overall sound power level is always constant.

Volume

The amount of audio level. If the volume increases, the audio level will increase, which results in a louder sound.

EXTENDED REFERENCE | THE CHANNEL STRIP

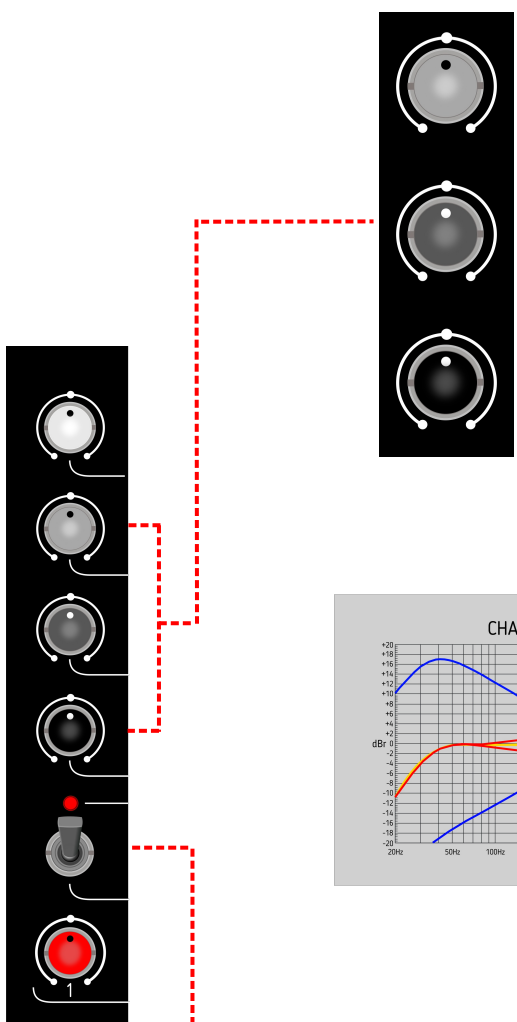

EQ

Equalization is the process of changing the spectral content of a sound dividing the spectra in bands and altering the gain of these bands by amplify or attenuate.

Each channel of the Hexmix has a three band EQ with level controls for Low (100Hz), Mid (1Khz) and High (100Khz) band frequencies. in a range of +/-12dB. This results in a sharp response and a bit aggressive character. You can check this in the following graphic.

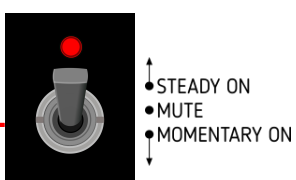
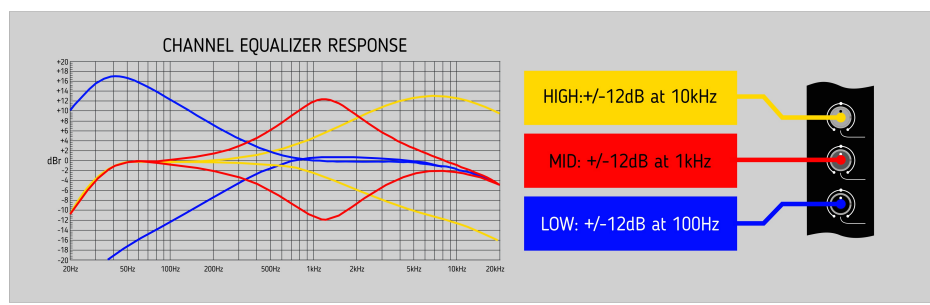

Mute

When audio signal is muted, his volume is turned off.

In Hexmix, the mute is made by a Vactrol based circuit. This topology provides a little release, wich provide a nice touch when used in its momentary function.

Mute is activated by a three position switch:

- Up: The signal stays on.
- Center: Mute
- Down: This position is momentary, so when the switch is released it returns to mute position.

EXTENDED REFERENCE | MASTER SECTION

Master section has it's own EQ and volume control for the mix of all channels. Master EQ is softer than individual channel's and it's meant to provide control over the final mix. It's possible to change output level from line to synth with S200 switch located in the back.

Main Output

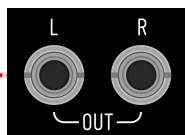

Main output for the mix of all channels. This output can work in modular or line level, depends on the position of S200 switch located in the backside of the module.

Master EQ

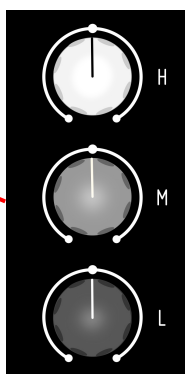

Equalization controls for the master section, this act over the mix of all channles. Unlike the Channel EQ, the Master EQ has +/-6 dB response. That results in a softer bandwidth amplification, perfect to make little changes and provide some color to the mix. In the following picture you can see a response graphic

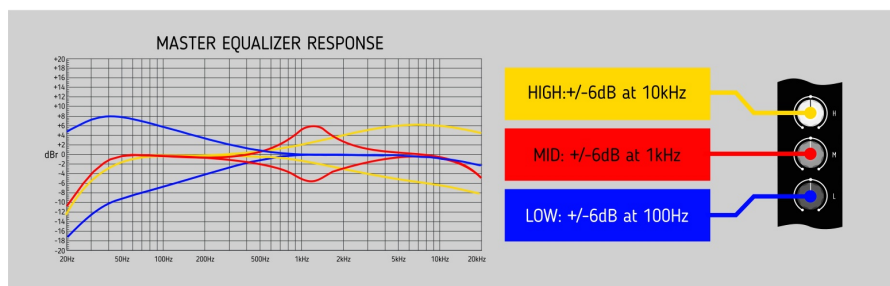

Master Control



Manual control for the volume of the Master Section. The bicolor leds on the top of the control shows the level of the mix. Green indicate presence of signal and red indicate signal clipping.

HEXPANDER

Now, let's focus our attention on the second half of the system, the Hexpander.

There are two connectors in Hexpander module, please read carefully before connecting the module in your rack.

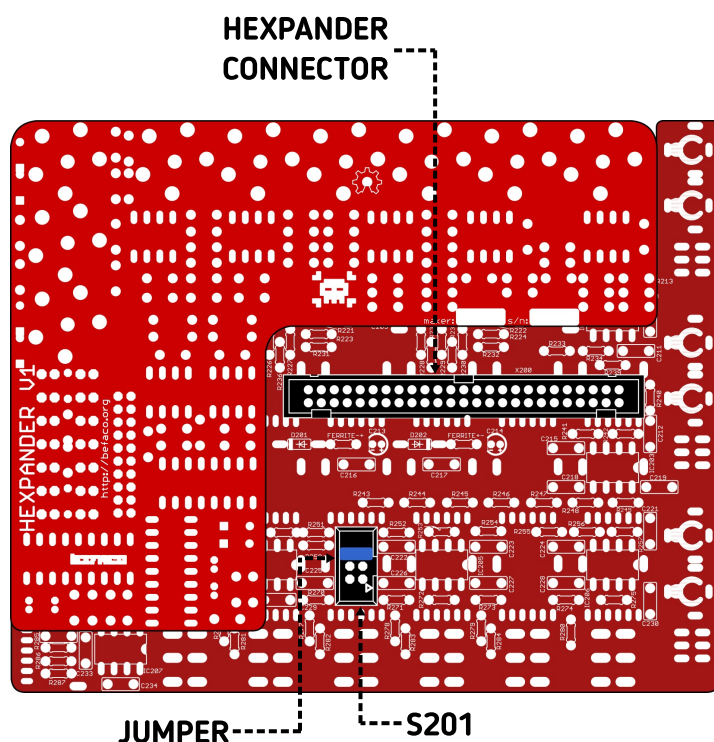

1. Hexpander Connector

The Hexpander have only one big connector in the backside. This connector power the module and handles the communication with the Hexmix

2. S201

Expansion port. Not used.... for now.

CONNECTING THE MODULE | PREVIOUS CONSIDERATIONS

1. **Disconnect your cabinet from the mains.**
2. Connect expander cable to your Hexmix module. Please use only provided cable.
3. If you have any questions about this product please send them to: befacosynth@gmail.com

MODULE REFERENCE | FRONT PANEL CONTROLS

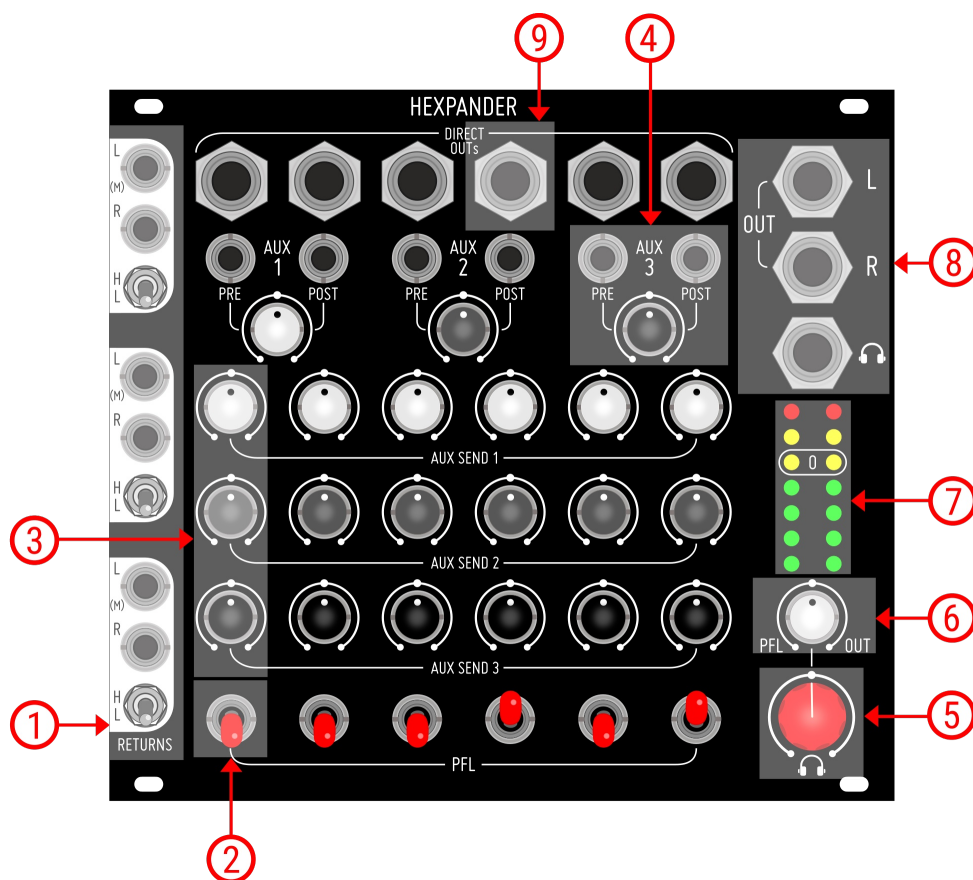

1. Aux Returns

Stereo return inputs with switched Line or Modular level signal.

2. PFL Switch

Activates pre-fader "cue" listening.

3. Aux Sends Controls

Level controls for each Auxiliary Send.

4. Aux Master/Outs

Pre and Post Fader auxiliary send outs, with master volume control.

5. Headphones Control

Manual control for Headphones Output volume.

6. PFL/Out Control

Manual control to crossfade between PFL and Master, at headphones out.

7. Level Peak Meter

LED level meter. Shows the level of master or PFL signal.

8. Main Outputs

Master Out and Headphones outputs in 6,5" Jack format.

9. Direct Outputs

Direct outputs (post Fader/EQ) for each channel.

EXTENDED REFERENCE | SENDS & RETURNS

Auxiliar Sends

An aux send, is a secondary mix usefull to add FX to more than one channel at time.

Every channel have three controls, for sending signal to one of each auxiliar send.

Every auxiliar send bus has a master volume pot, that will control the level of the signal sent. There are two jacks available so it is possible to send the signal pre or post fader in paralell, allowing to patch externally depending if its desired to have the original siganl sent even if channel is muted.

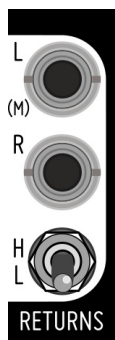
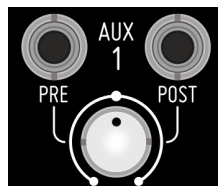

Auxiliar Returns

Returns are stereo, having a switch to select if the signal is coming from synth or line level. Like this levels can be adecuated, for example, either to a guitar pedal or a FX module at synth level. Use H (High) for synth signals, and L (low) for line level signals. If you want to use returns with mono signals, use L IN as mono input.

EXTENDED REFERENCE | MONITOR SECTION

Flip PFL switch to send the channel to the headphones out.

Level meter will show the level of the sum of all active PFLs. When there is no PFL active, it will show master level.

Headphones pot will control headphones out volume.

With PFL/Master Pot you can do a crossfade between the master signal and every channel sent to PFL, allowing you to listen to every track before adding them to the mix.

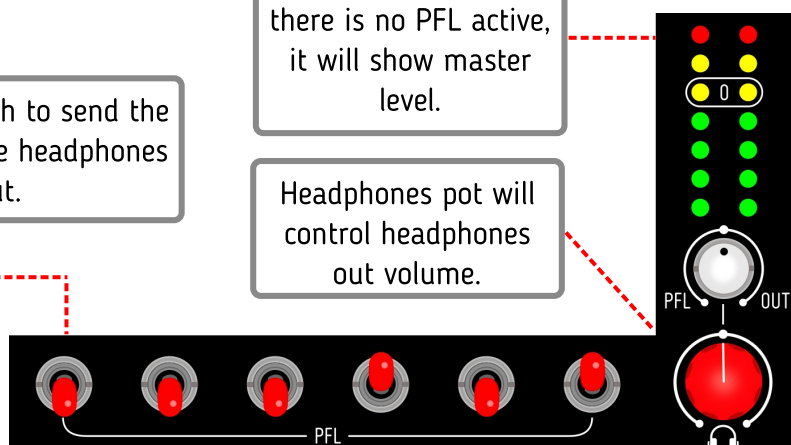

EXTENDED REFERENCE | OUTPUT SECTION

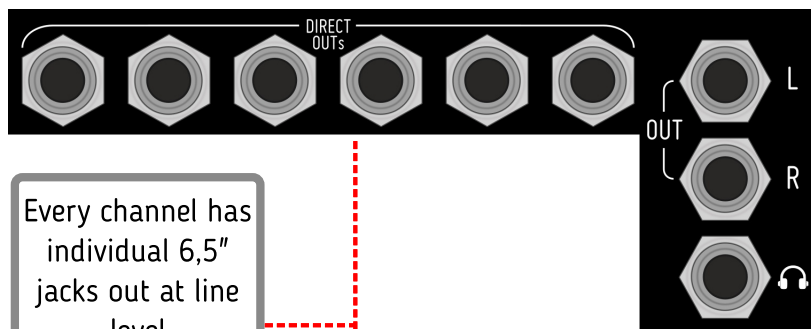

Every channel has individual 6,5" jacks out at line level (Unbalanced). Here you have the signal of every channel post fader/EQ

Headphone output. Monitor changes in your patch with the PFL function before adding the sounds to the mix.

The Hexpander provides, in addition of the Hexmix outputs, an extra main Impedance balanced 6,5" Jack outputs. It works in professional line level.

MISCELANEA | TECHNICAL SPECIFICATIONS

HEXMIX

Current Needs
+12V: 106mA, -12V: 88mA, +5V: 0mA

Width: 28 HP
Depth: 27mm

HEXPANDER

Current Needs
+12V: 137mA, -12V: 64mA, +5V: 0mA

Width: 28HP
Depth: 27mm

MISCELANEA | CREDITS AND INFO

Hexmix system was developed by Befaco Team during 2016 and 2017. Lead designer Pascual Rocher. Thanks to everyone that gave opinions and advices during the process and those who betatested and provided feedback to make Hexmix system a great performance mixer! Special thanks to Jano for the help on routing the SMD version and Juan Bermudez for his wisdom.



<https://www.befaco.org/en/hexmix/>
<https://www.befaco.org/en/hexpander/>