

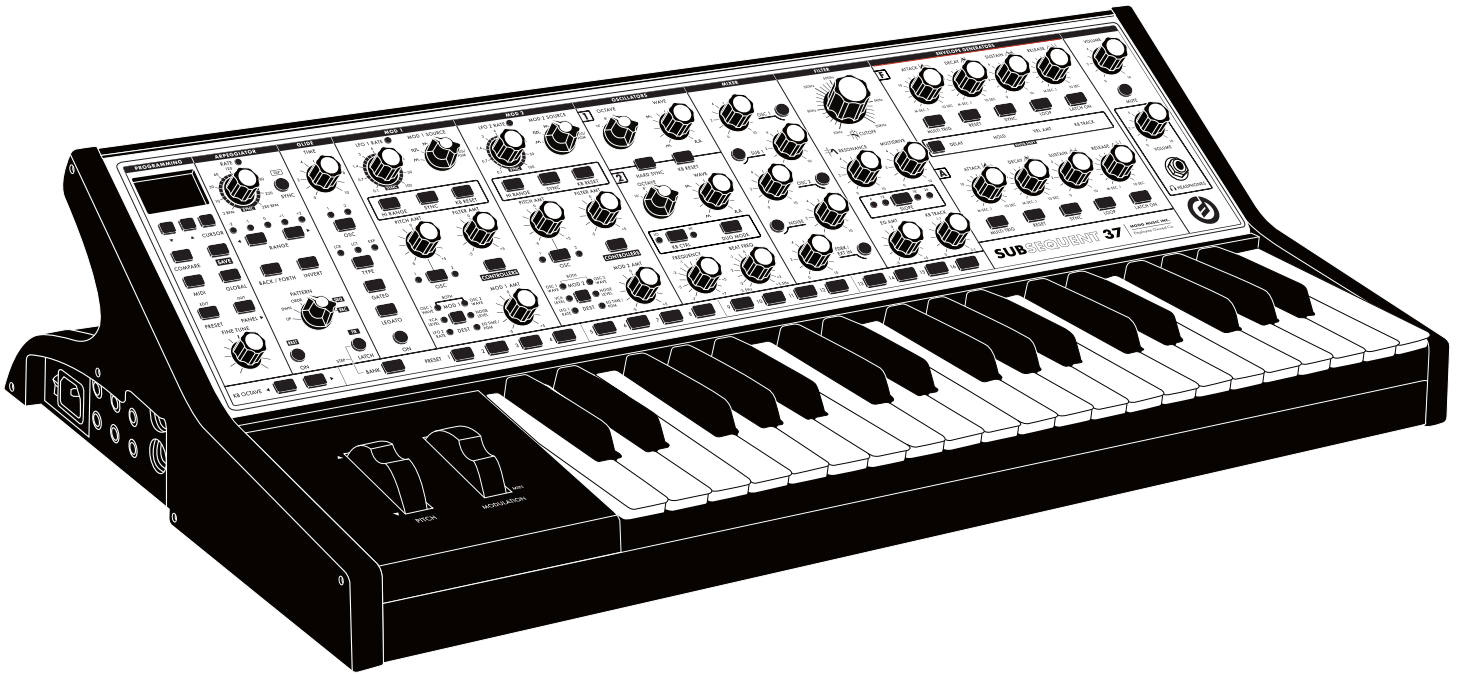

SUBSEQUENT 37

USER'S MANUAL



“I see my job as being one that must provide the artist with the capability of imparting complexity and dynamics to his music.” - Dr. Robert Moog

IMPORTANT SAFETY INSTRUCTIONS

WARNING - WHEN USING ELECTRIC PRODUCTS, THESE BASIC PRECAUTIONS SHOULD ALWAYS BE FOLLOWED.

1. Read all the instructions before using the product.
 - A. Keep these instructions. B. Heed all warnings. C. Follow all instructions
2. **WARNING:** Do not use this product near water. To reduce risk of fire or electric shock, do not expose this product to rain or moisture. - For example, but not limited to: near a bathtub, washbowl, kitchen sink, in a wet basement, or near a swimming pool or the like.
3. This product, in combination with an amplifier and headphones or speakers, may be capable of producing sound levels that could cause permanent hearing loss. Do not operate for a long period of time at a high volume level or at a level that is uncomfortable.
4. The product should be located so that its location does not interfere with its proper ventilation. Do not block any ventilation openings with any items including but not limited to newspapers, table-cloths, curtains, etc. Install in accordance with the instructions in this manual only.
5. The product should be located away from heat sources such as radiators, heat registers, or other products that produce heat. No naked flame sources (such as candles, lighters, etc.) should be placed near this product.
6. The product should be connected to a power supply only of the type described in the operating instructions or as marked on the product.
7. The power-supply cord of the product should be unplugged from the AC mains socket-outlet when left unused for a long period of time or during lightning storms.
8. Care should be taken so that objects do not fall and liquids are not spilled into the enclosure through openings.
9. Clean only with a dry cloth.
10. The product should be serviced by qualified personnel when:
 - a. The power supply cord or the plug has been damaged.
 - b. Objects have fallen, or liquid has been spilled onto the product.
 - c. The product has been exposed to rain.
 - d. The product does not appear to operate normally or exhibits a marked change in performance.
 - e. The product has been dropped or the enclosure damaged.

INSTRUCTIONS PERTAINING TO RISK OF FIRE, ELECTRIC SHOCK, OR INJURY TO PERSONS.

Do not open the chassis. There are no user serviceable parts inside. Refer all servicing to qualified personnel only.

GROUNDING INSTRUCTIONS: This product must be earth-grounded; if it should malfunction or breakdown, earth-grounding provides a path of least resistance for the electrical current to reduce the risk of electric shock. This product is equipped with a cord having an equipment grounding connector and a earth-grounding plug (plug with a third prong). The plug must be plugged into an appropriate socket outlet that is properly installed and earth-grounded in accordance with all local codes and ordinances.

DANGER: Improper connection of the equipment's earth-grounding connector can result in a risk of electric shock. Check with a qualified electrician or serviceman if you are in doubt as to whether the product is properly earth-grounded. Do not modify the plug provided with this product - if it will not fit in the socket-outlet, have a proper outlet installed by a qualified electrician.

NOTE: This equipment has been tested and found to comply with the limits for a class B digital device, pursuant to part 15 of the FCC rules. These limits are designed to provide reasonable protection against harmful interference in a residential installation. This equipment generates, uses and can radiate radio frequency energy and, if not installed and used in accordance with the instructions, may cause harmful interference to radio communications. However, there is no guarantee that interference will not occur in a particular installation. If this equipment does cause harmful interference to radio or television reception, which can be determined by turning the equipment off and on, the user is encouraged to try to correct the interference by one or more of the following measures:

- Reorient or relocate the receiving antenna.
- Increase the separation between the equipment and receiver.
- Connect the equipment into an outlet on a circuit different from that to which the receiver is connected.
- Consult the dealer or an experienced radio/TV technician for help.

CAUTION: Please note that any changes or modifications made to this product not expressly approved by Moog Music Inc. could void the user's authority granted by the FCC to operate the equipment.

TABLE OF CONTENTS

7	 UNPACKING & INSPECTION
7	 SETUP & CONNECTIONS
9	 OVERVIEW & FEATURES
9	 BASICS OF SOUND
12	 BANK & PRESET SELECTION
13	 PROGRAMMING SECTION
14	 KEYBOARD OCTAVE BUTTONS
15	 ARPEGGIATOR SECTION
17	 STEP SEQUENCER
18	 STEP EDIT MODE
21	 GLIDE SECTION
22	 MODULATION SECTION
25	 OSCILLATORS SECTION
27	 MIXER SECTION
28	 FILTER SECTION
29	 ENVELOPE GENERATORS
34	 OUTPUT SECTION
35	 MIDI MENU

TABLE OF CONTENTS

39 | PRESET MENU

43 | GLOBAL MENU

50 | CONTROLLERS MENU

52 | MIDI OPERATIONS

56 | NRPN OPERATIONS

60 | SERVICE & SUPPORT INFO

61 | SPECIFICATIONS

UNPACKING AND INSPECTION

Check the contents of the shipping carton

Be careful when unpacking the Subsequent 37 so that nothing is lost or damaged. Moog recommends saving the carton and all packing materials in case you ever need to ship the instrument for any reason.

The Moog Subsequent 37 ships with the following items:

- I. Subsequent 37 analog synthesizer
- II. Power cord
- III. Owner's manual
- IV. Registration card

What you will need:

- I. A stand or table sufficient to support the Subsequent 37
- II. Either a 1/4 inch instrument cable and amplified speakers or headphones with a 1/4 inch plug
- III. A properly wired AC outlet

SETUP AND CONNECTIONS

Place the Subsequent 37 on a stable surface such as a keyboard stand at a height suitable for playing comfortably.

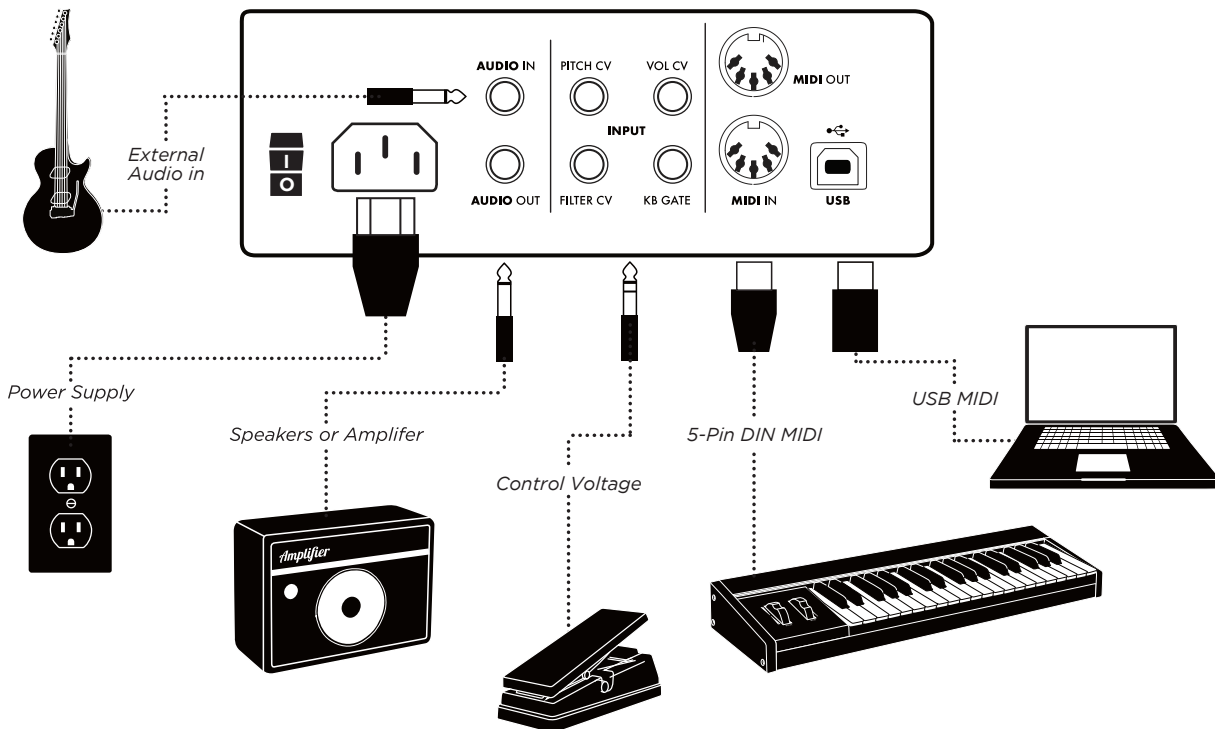

POWER

Plug one end of the supplied AC cord into the standard IEC power connector on the Subsequent 37's left-side panel. Plug the other end into an AC outlet. *Warning: An apparatus with CLASS I construction (such as this device) shall be connected to a MAINS socket outlet with a protective earthing connection.* The Subsequent 37's universal power supply will operate with 50/60Hz AC power sources ranging from 100 to 240 VAC / 50-60 Hz using 13W. Flip on the power switch located next to the power connector.

NOTE: *It may take as long as 60 seconds for the Subsequent 37 to warm up before oscillator tuning has stabilized if you've left it outside on a cold night. (Although its oscillators are surprisingly stable, the Subsequent 37 is an analog synthesizer, after all.)*

AUDIO OUT

With the **MASTER VOLUME** turned all the way down, plug one end of a 1/4 inch instrument cable into the Subsequent 37's **AUDIO OUT** jack and the other end into an amplified speaker or mixing console input. Adjust the level by slowly turning the **MASTER VOLUME** knob clockwise while playing the keyboard.

If you'll be using headphones, plug them into the headphones jack (on the front panel's bottom-right corner) with **HEADPHONE VOLUME** turned all the way down. Adjust the level by slowly turning the **HEADPHONE VOLUME** knob clockwise while playing the keyboard. Note that **MASTER VOLUME** must be turned up as well.

EXTERNAL AUDIO IN

Located just above the **AUDIO OUT** jack, the jack labeled **EXT IN** allows the Subsequent 37 to shape and filter external sounds. This is an unbalanced input that accepts a line-level signal.

NOTE: *You must press a key to pass external audio through the Subsequent 37. You also can use a Moog FS-1 footswitch, or simply press the **LATCH ON** button in the Amplifier Envelope section and make sure that the Amplifier Envelope's **SUSTAIN** level is up.*

USB

To use the Subsequent 37 with a computer, connect one end of a USB cable to the Subsequent 37's USB port and the other end to an available USB port on your computer. The Subsequent 37 supports MIDI I/O over USB, but not audio data. The Subsequent 37 is class compliant. No drivers are required for USB MIDI connectivity.

MIDI

Using the Subsequent 37 with an external MIDI device requires one or two MIDI cables. To use the Subsequent 37 as a MIDI controller, connect one end of a MIDI cable to the Subsequent 37's **MIDI OUT** jack and the other end to another device's **MIDI IN** jack.

To control the Subsequent 37 from an external MIDI controller, connect one end of a MIDI cable to the Subsequent 37's **MIDI IN** jack and the other end to an external controller's **MIDI OUT** jack. By default, the Subsequent 37 is set to transmit and receive MIDI data on MIDI Channel 1.

CONTROL VOLTAGE IN

The **PITCH CV**, **FILTER CV**, and **VOL CV** inputs each accepts an expression pedal (such as the Moog EP-3) or a control voltage signal from 0 to +5 volts. If you connect a TRS expression pedal to **VOL CV**, you can use your foot to control the Subsequent 37's output level. If you connect a TRS expression pedal to **FILTER CV**, you can sweep the filter cutoff in the same manner. The **PITCH CV** input is calibrated so that a one-volt change in the control voltage will result in a one-octave change in frequency.

The **KB GATE** input accepts a +5 volt signal, which causes the Subsequent 37's envelopes to trigger.

OVERVIEW AND FEATURES

The Subsequent 37 is a 2-note paraphonic analog synthesizer, built in the tradition of classic Moog synthesizers. It is housed in a rugged black steel chassis with aluminum extrusion, and finished with classic wood sidepieces. Your new Subsequent 37 starts with a high-quality, 37-note keyboard that has both velocity sensitivity and aftertouch. This offers a highly expressive and musical playing experience. All critical performance and sound design features are provided directly on the front panel, which is equipped with 40 knobs and 74 switches. This makes creating, saving, and retrieving your own sounds fast and effortless. Each knob and switch on your Subsequent 37 also sends and receives MIDI, making the Subsequent 37 a completely automatable analog synthesizer and powerful MIDI controller.

Unlike its smaller sibling, the Subsequent 37 has the ability to play more than one note at a time via a new function called DUO MODE. This allows each of the Subsequent 37's highly stable oscillators to play completely independent pitches from one another. Voices are then processed through a single, classic 20Hz-20kHz Moog Ladder Filter. The Filter section has a dedicated selector switch for filter slope, and control for MultiDrive. When combined with the new Mixer Feedback function, a vast array of sound creation possibilities become available.

The Subsequent 37 boasts 2 fully assignable modulation busses, 2 DAHDSR looping envelopes, and a powerful arpeggiator with a paraphonic 64-note step sequencer. Each of these sections has a dedicated SYNC switch, which allows you to easily determine which features are synchronized to MIDI, internal clock, or running free.

With its extensive feature set and one-knob-per-function design, the Subsequent 37 is the ideal instrument for any synthesist, sound designer, or performing musician.

BASICS OF SOUND

If you're new to the world of music synthesis, it helps to have at least a rudimentary understanding of music and acoustics. Even if you know this stuff like the back of your hand, it never hurts to approach it from a fresh perspective.

Several qualities distinguish one musical sound from another, including pitch, loudness, duration, and timbre. Being able to manipulate those qualities allows you to turn raw sound into music.

Simply put, sound occurs when a vibrating object causes the air around it to vibrate. That object could be a guitar string, a loudspeaker, or anything capable of rapid movement. An individual vibration is called a wave or cycle, and the rate of vibration is called frequency. Frequency determines the sound's pitch, and pitch determines how high or how low you perceive the sound on a musical scale. Frequency is measured in Hertz (abbreviated Hz), which describes the actual number of times that something vibrates every second. One thousand cycles per second is called a kilohertz (kHz).

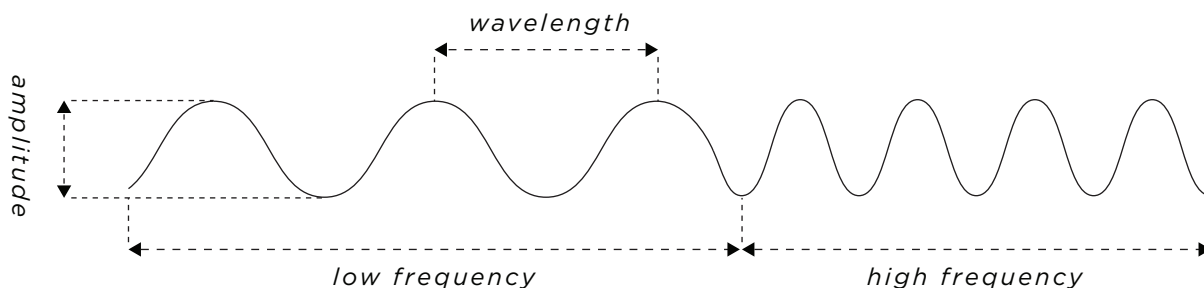

BASICS OF SOUND (CONTINUED)

Amplitude—the intensity of vibration—determines a sound’s loudness. A high-amplitude sound is loud, and a low-amplitude sound is soft. A vibrating source’s loudness depends on the amount of air it displaces, and that depends on how hard it vibrates.

It’s difficult for anyone to identify a musical instrument simply by the pitch or loudness of the sounds it makes. Every musical sound also has a characteristic tone color or timbre (pronounced tam’-br, as in tamborine, not tim’-br, as in a tree falling). Differences in timbre make it possible to distinguish one instrument from another.

If you analyze a single cycle of a musical sound, you can perceive it as a complex combination of simple sine waves, each wave different in frequency and amplitude. When their frequencies are whole-number multiples of each other (and in musical sounds, they usually are), those simple waves are called harmonics. A sound’s timbre depends on its harmonic content. The first harmonic—the one with the lowest frequency and usually the greatest amplitude—determines its pitch. Higher harmonics are often called overtones. Normally, the higher the overtone’s frequency, then the weaker its amplitude.

When those harmonics are combined in a musical sound, a single cycle of that sound has a specific shape, which synthesists call a waveform. Just as the frequencies and relative amplitudes of the sound’s harmonics determine its waveform, the waveform determines the sound’s timbre.

Instead of producing sounds acoustically the way vibrating objects do, synthesizers generate electrical signals that are amplified and converted to sound. Just as sound has frequency and amplitude, so does the kind of alternating current produced by a synthesizer. An analog synthesizer’s primary sound source is called an oscillator.

The oscillator’s waveform, of course, determines the sound’s harmonic content. Some waveforms are rich in harmonics, while others have relatively few. Depending on the waveform, some overtones may be absent altogether. Waveforms with lots of overtones, such as sawtooth and square waves, are harmonically the most complex. Waveforms with fewer overtones, such as triangle and narrow pulse waves, are harmonically less complex.

Rather than building up waveforms one harmonic at a time, the way a Hammond organ does, analog synthesizers like the Subsequent 37 provide the means to shape and filter complex, harmonically rich waveforms to selectively remove, reduce, or emphasize specific harmonics—a technique called subtractive synthesis.

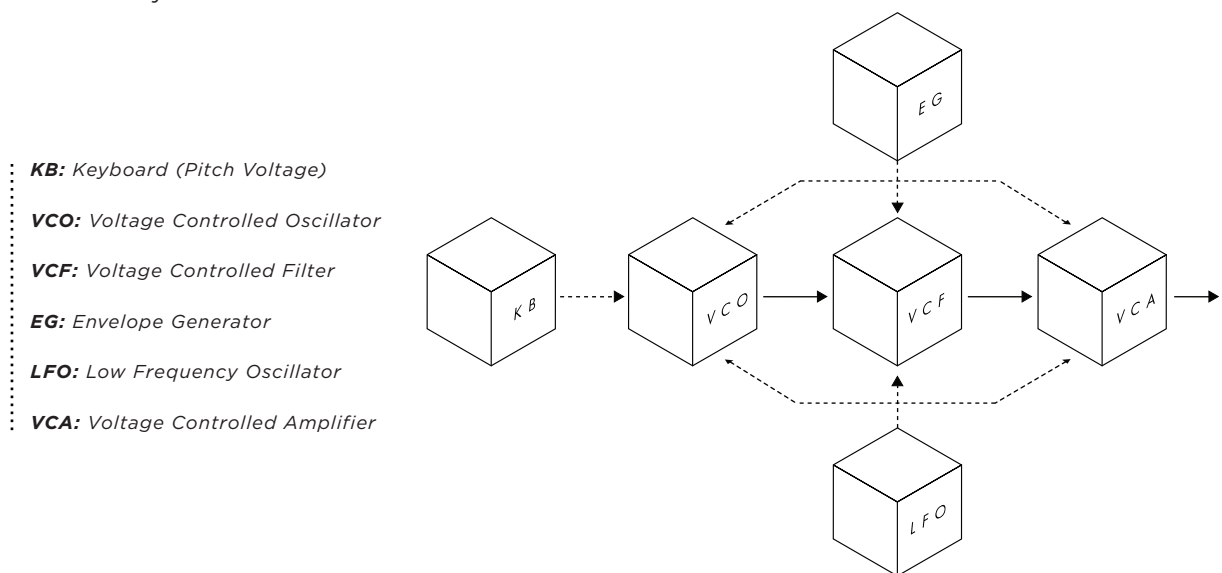

The Subtractive Synthesis Model

The oscillators, filter, modulators, and other parts are connected in the most useful ways for producing and modifying electronic signals that result in sounds. Unlike on a modular synthesizer, many connections between the Subsequent 37's various parts are hardwired, meaning that it is not possible to change the routing of the pathways that connect them.

The electrical signals within a synthesizer are either audio signals or control signals, depending on the pathway they follow. Typically, an audio signal begins with an oscillator and passes through the filter on its way to the audio output. Control signals are used to change things, like the pitch, timbre, waveshape, or loudness of an audio signal.

Any time a signal controls something, no matter whether it's controlling an audio signal or another control signal, we say that it modulates it. In synth-speak, you could say that a steering wheel modulates a car's direction and the accelerator pedal modulates its speed. When you play the Subsequent 37's keyboard, the key you press modulates the instrument's pitch. You can modulate filter cutoff by turning a knob manually, or you can apply a control signal from a low-frequency oscillator or envelope to modulate it electronically. It's worth noting that a control destination can be modulated by more than one control source.

The diagram below illustrates how the Subsequent 37 generates sound. It shows the flow of audio signals, represented by solid lines, and control signals, represented by dotted lines.

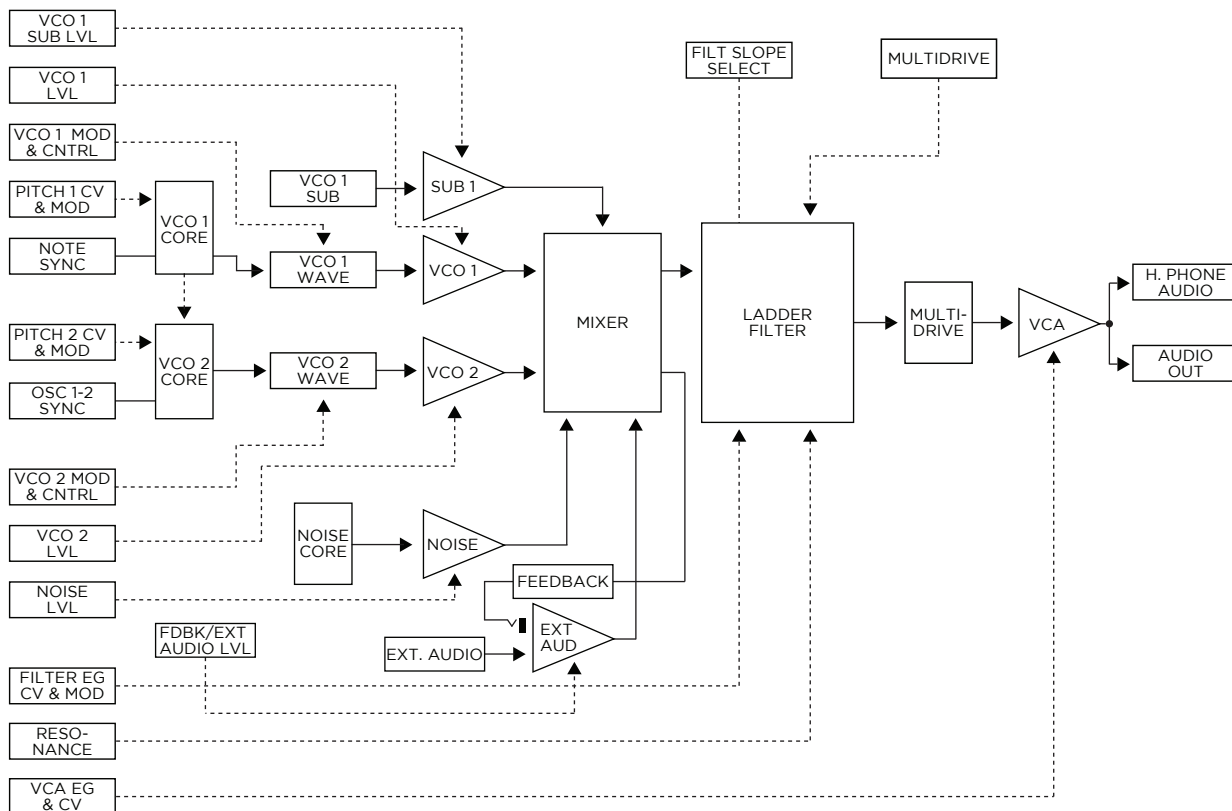

You can control the Subsequent 37 using control voltages and MIDI commands. When the Subsequent 37 receives either a control signal from the onboard keyboard or a Note On command from an external MIDI source, it responds by sending a gate signal to trigger the envelopes and a control voltage (CV) to control oscillator pitch. The envelopes respond by sending control signals to the amplifier and filter.

Every knob and button on the Subsequent 37 transmits MIDI data (when in NRPN Mode). This functionality is useful for recording your knob turns and button presses into a computer-based DAW, as well as for controlling external devices using the Subsequent 37's front-panel controls. All the settings that make up a patch are called its parameters, which is simply another name for settings.

BANK & PRESET SELECTION

The Subsequent 37 ships with 256 user-editable preset locations, which are arranged in 16 banks of 16 patches per bank. The following section will show you how recall existing patches, and also how to edit and save your own patches. (The word patch is a holdover from modular synthesis, which requires patch cords to connect the various modules.)



SELECT A BANK & PRESET (USING BANK/PRESET BUTTONS)

1. Press the **BANK** button, which will illuminate.
2. Press one of the **PRESET** buttons labeled 1 - 16. Your bank is now selected. (The **BANK** and **PRESET** buttons will darken until a new preset is selected).
3. Now select a preset from within your selected bank by pressing the desired **PRESET** button labeled 1 - 16. The corresponding **PRESET** button will now remain illuminated.

NOTE: If you press a **PRESET 1 - 16** button without first pressing **BANK**, you will simply choose presets from within the current bank.

Take your time, listen to all the presets, and turn some knobs to get a feel for how you can use them to alter sounds. To return to the original stored preset, just select it again by pressing the currently illuminated **PRESET** number button.

NOTE: If your display screen is not in **PRESET** mode and you wish to see which bank you are currently in, press the **BANK** button and one of the buttons from 1 - 16 will illuminate. Press the **BANK** button again to return to **PRESET** selection mode.

SELECT A BANK & PRESET (USING CURSOR AND ▼ ▲ BUTTONS)

Make sure that the **PRESET** button in the **PROGRAMMING** section is lit. The display screen will show the title of the preset (one or two lines) followed by its bank (BNK) and preset (PRESET) numbers. The last line shows the category (CAT) for that preset.

You can scroll through individual presets by using the **CURSOR** button to highlight the PRESET number field. Now use the ▼ ▲ buttons to scroll through all 256 presets. If you press and hold either button it will scroll rapidly.

As you pass the 16th preset in a bank, the Subsequent 37 will jump to preset 1 in the next bank.

BROWSING ALL PRESETS IN A SPECIFIC CATEGORY

1. Press the **CURSOR** until you have highlighted the category type (MISC, LEAD, BASS, BRASS, etc.).
2. Now use the ▼ ▲ buttons to scroll through available category types.
3. Once you have made your selection press the **CURSOR** button until you have highlighted **CAT**.
4. The ▼ ▲ buttons will now allow you to scroll through every patch in your selected category.

NOTE: Category types can be assigned when you are in the **SAVE** mode.

SAVING AND NAMING PRESETS

Saving presets is a simple maneuver. Just remember that whenever you save a preset to a particular location, the preset previously stored in that location will be deleted.

TO SAVE A PRESET:

1. Press the **SAVE** button.
2. You will be given an opportunity to name your preset. Use the ▼ ▲ buttons to select a character, and use the **FINE TUNE** knob to scroll through the available characters. Now use the ▼ ▲ buttons to select **CAT** (Category), and the **FINE TUNE** knob to assign your preset to a sound category. Press **SAVE** to accept. (You can also press **CURSOR** and use the ▼ ▲ buttons to edit an individual character).
3. Using the **BANK/PRESET** buttons on the bottom of the front panel, select a save location for your preset. (If you are already in the bank you want, you can simply choose from **PRESET 1-16**).
4. Press and hold **SAVE** for one second to confirm and complete the save process. To cancel saving, simply press the **PRESET** button.

NOTE: When you first press the **SAVE** button, the current positions of all sound controls are frozen so that they can be saved with the preset.

PROGRAMMING SECTION

The Subsequent 37 has a wealth of user-selectable features and functions not found on its panel. The **PROGRAMMING** section allows you to easily access and update any of these things expediently.

Dec ▼, Inc ▲, and **CURSOR** buttons: These buttons are used for selecting presets, menu navigation, and editing parameters shown on the Subsequent 37's LCD display panel.

COMPARE

This button allows you to load an existing preset without discarding any changes you have made to a current sound. To alternate between a stored preset and a currently modified sound simply press the **COMPARE** button. When the **COMPARE** button is illuminated, you are listening to a stored preset and no changes can be made to the sound. When in this mode you can, however, audition different presets without discarding your currently modified sound. When the **COMPARE** button is dark, you have exited **COMPARE** mode and are listening to your currently edited sound.

NOTE: You can also press **PRESET** to exit compare mode.

SAVE

This button is used to initiate the saving of a preset.

MIDI / GLOBAL

These buttons allow you to access and edit system settings for your Subsequent 37 including MIDI channel selection, pot modes, and keyboard note priority. This is also where you find useful operations like note calibration and exporting presets. To learn more about **MIDI** and **GLOBAL** settings, go to page 35 (MIDI) and page 43 (GLOBAL).

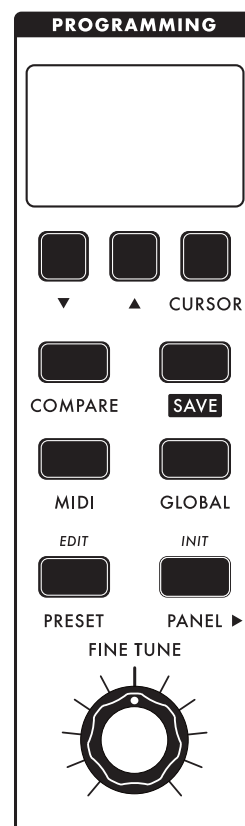

PROGRAMMING SECTION (CONTINUED)

PRESET / PANEL

These buttons select the performance mode of your Subsequent 37. In **PRESET** mode, the sound you hear reflects the position that the panel knobs and buttons were in when the preset was saved, regardless of their current position. In **PANEL** mode, the sound you hear reflects the current position of the front-panel knobs and buttons. Parameters in this mode (other than the knobs) are saved in a special buffer, so you can pre-set the panel to retain any non-knob settings you choose. Any sequence data you have created before exiting the **PANEL** mode will also be stored to this buffer. To load the **PANEL** settings without loading its sequence, hold **BANK** while pressing **PANEL** to enter panel mode.

PRESET EDIT

Press and hold the **PRESET / EDIT** button to enter the **PRESET EDIT MENU**. This is where additional preset parameters that would not fit on the front panel are located. To learn more about the **PRESET EDIT MENU**, go to page 39.

INITIALIZE PANEL

Press and hold the **PANEL / INIT** button to initialize the Subsequent 37 panel settings to a default state. This is a great place to start when creating new sounds from scratch.

FINE TUNE

Use this knob to adjust the frequency of both oscillators as much as one semitone up or down from its center position. Fine-tuning is useful for putting the Subsequent 37 in tune with any other instruments that deviate slightly from standard pitch.

KEYBOARD OCTAVE BUTTONS

Use the **KB OCTAVE** buttons to extend the Subsequent 37's keyboard from its normal three-octave range to a full seven octaves.



Pressing the ◀ button once transposes the Subsequent 37's pitch down an octave. Pressing it again transposes it down another octave. Likewise, pressing the ▶ button transposes the pitch up an octave, and pressing it again transposes it up another octave. When neither button is illuminated the Subsequent 37's keyboard is playing in its standard octave. When a **KB OCTAVE** button is dimly lit, the keyboard is transposed a single octave. When a **KB OCTAVE** button is brightly lit, the keyboard is transposed two octaves.

***NOTE:** Since this is an analog synthesizer based on 1 volt-per-octave scaling, the extreme high and low ranges of the keyboard may play notes that are not perfectly in tune.*

The **KB OCTAVE** buttons also transpose the MIDI Note Numbers that the Subsequent 37 transmits by corresponding amounts.

DEFAULT KB OCTAVE

Briefly pressing both **KB OCTAVE** buttons together will reset the Subsequent 37 to its standard octave regardless of current octave selection.

QUICK KEYBOARD TRANSPOSE

While holding both the **KB OCTAVE UP** and **DOWN** at the same time, play any single note in the lower two octaves of keys to transpose the entire Subsequent 37 keyboard from -12 half-steps to +12 half-steps. Pressing Middle C will set the transposition to +0 (default). Keys to the left of Middle C will transpose downward, and keys above Middle C will transpose upwards. The **KB TRNSPOSE** value will be reflected in the **PRESET EDIT 1.5** parameter as well. This is stored as part of the preset.

MIDI PANIC

Holding both **KB OCTAVE** buttons at the same time for about one second will send a MIDI Panic (All Notes and Controllers Off) message.

ARPEGGIATOR SECTION

With the Arpeggiator **ON** button lit, any note or group of notes you play will be sequenced according to the settings in the Arpeggiator section and menu. You can also record and playback a 1 to 64 note step sequence, which can be stored with each preset.

LATCH

When **ON**, the Arpeggiator will keep looping in its current state without the need to hold a physical note. A new note or group of notes will initiate a new note sequence based on the Arpeggiator Menu settings. If notes are played and held while **LATCH** is **ON**, playing additional notes will add to the current list of notes to be arpeggiated. If all notes are released, the first new note played will initiate a new note sequence.

RATE

This knob sets the rate of the arpeggiator from 2 BPM (beats-per-minute) to 280 BPM. When the **SYNC** button is illuminated the **RATE** knob is used to select clock divisions of the Subsequent 37's internal clock or an external MIDI clock. For more information on MIDI clock divisions, go to page 52.

SYNC

When **ON** this button synchronizes the arpeggiator to external MIDI clock messages. MIDI clock messages are 24 ppq (pulses-per-quarter-note) messages that can be sent via MIDI computer sequencers, drum machines, etc... To enable the sending of these messages, consult the user manual for your external MIDI device. When the arpeggiator is synchronized to a MIDI clock tempo, the arpeggiator can be set to time divisions of this tempo using the arpeggiator's **RATE** knob. (Time divisions range from 4 whole notes up to a 64th note triplet).

WARNING: When **SYNC** is **ON**, and you are not in **TAP TEMPO** mode, the arp/sequencer will not play unless MIDI clock is received.

[TAP]

The **SYNC** button can also be used to set the arpeggiator's rate to a desired tempo. To initiate Tap Tempo of the arpeggiator, press and hold the **SYNC** button for 1 second. You can now tap the **SYNC** button switch at the tempo you want (1/4 notes). On the third tap, the Subsequent 37's internal clock will change rates to match the timing of the switch presses. If you continue to tap the **SYNC** switch, the internal clock will be set by a running average of the time between switch presses. To start over, wait five seconds and then tap the **SYNC** switch three times to set a new tempo. To exit the Tap Tempo mode press and hold the **SYNC** button for 1 second.

RANGE

Use the **RANGE** buttons to choose how many octaves the arpeggiator will play above or below the actual notes pressed. The LEDs will indicate -2 octaves, -1 octave, 0 octaves, +1 octave, or +2 octaves. If you press either **RANGE** button more than two times you will light up both the 0 and the -2 or +2 LEDs. In this mode the arpeggiator will play all the notes in the original octave, the 2nd octave, the 3rd octave, and then back to the 2nd octave before returning to the original octave.

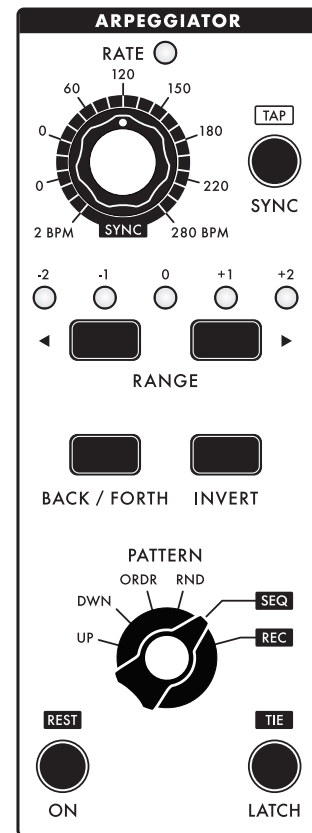

ARPEGGIATOR SECTION (CONTINUED)

BACK / FORTH

When the **BACK / FORTH** button is illuminated the arpeggiator will play the **UP** or **DWN** patterns in a bi-directional fashion, making **UP** play up then down, and making **DWN** play down then up.

For example, if you choose the **UP** pattern without the **BACK / FORTH** button and hold C-E-G, you'll get C-E-G-C-E-G etc. But, if the **BACK / FORTH** button is lit you'll get C-E-G-E-C. If the **PATTERN** switch is set to **ORDR** the arpeggiator will play notes in order and then in reverse order. The **BACK / FORTH** setting has no effect on the **RND** pattern.

***NOTE:** There is a parameter in the **PRESET EDIT MENU** (Page 39) called **END NOTES** that determines if the beginning and ending notes of the arpeggiation are played once (**ONCE**) or twice (**TWICE**) when they change direction. For example, if you're arpeggiating C-E-G using the **UP** Pattern with the **BACK / FORTH** button lit, you get C-E-G-E-C etc. if you choose **ONCE**. If you choose **TWICE** you'll get C-E-G-G-E-C-C etc.*

INVERT

When the **INVERT** button is lit the arpeggiator will play each note in two or three successive octaves before moving to the next note. If the **RANGE** parameter is set to **+1** with **INVERT** lit, and you hold C-E-G, you will get C, C up one octave, E, E up one octave, G, and G up one octave. Because this function is octave based, the **INVERT** button will have no effect if the arpeggiation **RANGE** is set to **0**.

PATTERN

Use the **PATTERN** knob to choose the manner in which notes are played back by the Subsequent 37 arpeggiator. When **UP** is selected, held notes will play back in order of pitch from lowest to highest. When **DWN** is selected, held notes will play back in order of pitch from highest to lowest. When **ORDR** is selected, held notes will play back in the order they were held. When **RND** is selected, held notes will play back in a completely random order.

You can also use the **PATTERN** knob to select the Subsequent 37's built-in Step Sequencer. If the arpeggiator is not running, setting the **PATTERN** knob to **REC** and playing a new note will clear any existing sequencer data. This allows you to record a new Step Sequence containing up to 64 notes. If you turned the **PATTERN** knob to **REC** by mistake, that's okay. Simply turn it back to the desired position and your original sequence will still be there. Learn more about the step sequencer on page 17.

ON / REST

The **ON** button is used to engage or disengage the arpeggiator, allowing you to pre-set the arpeggiator and then turn it on as needed. When in Step Sequence Record mode, the **ON** button becomes **REST**. Pressing the **REST** button will advance to the sequencer to the next step and add a silent **REST** to your Sequence.

LATCH / TIE

When **ON**, the **LATCH** button allows the Subsequent 37 to continue playing an arpeggio or sequence even after all the keys have been released. When in Step Sequence Record mode, pressing the **LATCH** button becomes **TIE**, which will connect your previous note to the next note you play without advancing to the next step in a sequence.

STEP SEQUENCER BASICS

With the arpeggiator disengaged (**ON** button is darkened), turn the **PATTERN** knob to **REC**. The next key you press will erase any existing step sequence data and enter a note for step 1. The LCD display will also show **REC 01 / 01**, indicating that you have recorded step 1 of a (so far) 1-step sequence. Each successive key press (or **REST**) will advance you to the next step number for up to 64 steps.

After entering a note, pressing the **TIE** button will tie (connect) your previous note to the next note you play. If you play a different note from the previous one using a tie, you will hear the new pitch without triggering the envelopes. If you play the same note as the previous one using a tie, you will effectively double the length of the note.

NOTE: With *Glide* set to **ON** and the **LEGATO** button illuminated, the glide effect will only occur between the tied notes.

You can also create a tie between two different notes by pressing a second note before releasing the previous note. This shortcut will not work if you are in **DUO MODE**.

After recording your step sequence, turn the **PATTERN** knob to **SEQ**. Then press the Arpeggiator **ON** button. Now you can play back your step sequence in any transposition by pressing a key. The key you press will be the starting note of your step sequence.

NOTE: In the **GLOBAL MENU**, if you set **REF NOTE** to be **MID C**, then pressing Middle C will play back your step sequence exactly as you recorded it. Playing C# will play back your sequence a half step up. Playing the Bb below Middle C will play your sequence a whole step lower.

STEP SEQUENCING IN DUO MODE

With **DUO MODE** engaged, you can choose (per step) whether to enter one or two notes together. When two notes are played simultaneously, the sequencer captures two separate pitches. The **KB CONTROL** settings determine which oscillator follows which note.

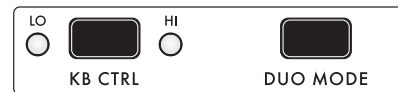

When you play the sequence back you will hear both notes on steps that were recorded with two notes, and both oscillators playing together on steps in which only one note was pressed.

During playback, if you hold down two notes, all of the recorded duo notes will play back normally. Any single recorded notes, however, will follow your two keys as dictated by **KB CTRL** settings. This allows you to play real-time pitches along with a step sequence any time there is only one note recorded in a step.

If your step sequence consists only of single notes you can play along with your own melody. If your step sequence consists only of duo notes, then playing a second key during playback will have no effect.

NOTE: A step sequence can be stored with each preset. This means you can store multiple versions of a single preset, allowing you to switch between different sequences while continuing with the same sound.

STEP EDIT MODE

Using the Step Edit mode you can edit everything about every step of a sequence (in real or non-real time). For each step, this includes the note number of either one or two notes, the velocity of the step, whether there's a rest or a tie, and the per-step **SEQ MOD** value. You can also decide (non-destructively) which step is the first step, and which step is the last step of the sequence. You can **ROTATE** (shift) the pattern relative to the downbeat, **SKIP** any desired steps, and add a rapid note subdivision to any step via **RATCHET**.

ENTER / EXIT STEP EDIT MODE

Set the **ARPEGGIATOR PATTERN** knob to either **SEQ** or **REC**. Then hold the **BANK** button and press the **LATCH** button to enter or exit **STEP EDIT MODE**. You can also exit Step Edit mode by moving the **PATTERN** knob away from **REC** and **SEQ (UP, DWN, ORDER, or RND)**.

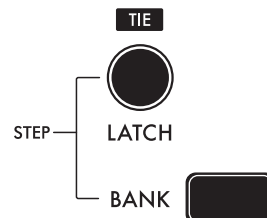

In **STEP EDIT MODE**, the **PRESET** buttons (1 - 16) are used to show and edit the pattern's step data. Steps 1 through 64 are displayed as four pages, with each page representing 16 of the steps at a time. To change which sequence page is currently displayed, hold the **BANK** button and press the **KB OCTAVE** ► button to increment the sequence page, and the **KB OCTAVE** ◀ button to decrement the sequence page. The page number is indicated (P1 - P4) in the bottom right corner of the LCD display.

SEQ PG CHASE (Located in GLOBAL MENU 2)

Toggles the page-chase behavior for the sequence page display. When **ON** (default) the step buttons (**PRESET 1 - 16**) will first show steps 1 - 16, and then steps 17 - 32, then 33 - 48, etc. When **SEQ PG CHASE** is **OFF**, the step buttons will remain on the sequence page selected by the user.

VISUAL INDICATIONS OF STEP EDIT MODE

When the **BANK** button is pulsating slowly, it indicates that you are in Step Edit mode. These pulses also indicate that no specific step has been chosen for editing.

The bottom line of the LCD gives four pieces of information (from left to right):

- Stop ■, Play ►, and Pause || show the sequence's play status.
- **EDIT** indicates that you are in Step Edit mode.
- **CURRENT STEP (1/XX)** shows which step of a sequence you are on.
- **LAST STEP (X/64)** shows the last step number; after playing the last step, the sequence will repeat from the beginning.

The **PRESET** buttons are lit dimly for active steps, dark for rests, and dark for all steps after the last step.

Ex. For an 8-step sequence with a rest on step 5, steps 1 - 4 and 6 - 8 would be dimly lit. Steps 5 and steps 9 - 64 would be dark.

During playback, the current step is lit at full brightness. This brightness will chase across the **PRESET 1 - 16** buttons in sync with the sequence playback.

EDITING A STEP

To select a specific step for editing, hold the **BANK** button and press a step button [**PRESET 1 - 16**]. The **BANK** button will go dark, and the selected step button now pulsates. Now that you've selected a step for editing, you can choose any other step to edit by simply pressing that desired step's button.

To exit this mode (and deselect any step for individual editing), simply press the **BANK** button. The **BANK** button will resume pulsing, and the previously selected step button will return to its specified state (active, rest, currently playing, etc.) as described above.

EDITING A STEP (CONTINUED)

While a step is selected for editing:

REST [ON] and **TIE [LATCH]** buttons show and toggle the rest or tie state for the selected step.

Note entry (via keyboard or MIDI) edits the pitch of the selected step as follows:

- Any non-legato note sets Pitch 1 and clears the Rest, Tie, and Ratchet data.
- Any legato note sets Pitch 2.

NOTE: If the **DUO MODE** button is held when a note is entered, then the note entry sets Pitch 2 without modifying Pitch 1.

If, during step editing, the **PATTERN** knob is set to **REC** (instead of **SEQ**), then the selected step also determines the step from which step recording will commence. After the release of all notes, the step is deselected and the sequence is advanced to the next step. The Subsequent 37 is now ready to record all further notes in the normal fashion for step recording.

TIE GROUPS OF STEPS

Hold a step button and press another step button to Tie these steps and any steps in-between together. If the last step of this new Tie group was already set with a Tie, then the original Tie will be cleared. Press the same two step buttons together a second time to un-Tie all the notes in the group.

TOGGLE STEP REST STATE

Press and release a single step button to toggle Rest on/off.

SET FIRST STEP/LAST STEP

To set a certain step as the sequence's first step, press and hold the desired step button and press the **KB OCTAVE ◀** button. To set a certain step as the sequence's last step, press and hold the desired step button, and press the **KB OCTAVE ▶** button.

NOTE: You can also **CURSOR** to the last step number displayed on the LCD and dictate a new last step using the **▼ ▲** buttons.

ROTATE PATTERN

You can shift the entire sequence's step data "left" or "right" (relative to the downbeat) by holding **BANK** and pressing the **ARPEGGIATOR RANGE [<]** and **[>]** buttons.

BANK + RANGE [<] shifts the pattern to the left by one step per press.

BANK + RANGE [>] shifts the pattern to the right by one step per press.

NOTE: When rotating patterns, there are two Sequencer Transpose modes found in the **GLOBAL MENU 2.2/SEQ OPTIONS** sub menu. The options are **FIRST** (First Note - default) or **MID C** (Middle C plays recorded pitch). If transposition is based on "First Note" and you rotate a pattern, this will affect how the sequence is transposed when you play a new key on the keyboard. The new first note becomes the new root note for transposing from the keyboard. In **MID C** mode, playing Middle C on the keyboard (note 48) will cause the sequence to play in its recorded key, regardless of which pitch has been rotated to be the first in the sequence. If you plan on Rotating your patterns while playing live, it's best that you choose **MID C** in the **GLOBAL MENU 2.2/SEQ OPTIONS** sub menu.

SKIP

To toggle **SKIP** on/off for a step, hold the desired step's button and then press the **ARP ON [REST]** button. Skip allows you to temporarily remove a step from a sequence. The note prior to the Skipped note will proceed directly to the note after the Skipped note.

STEP EDIT MODE (CONTINUED)

RATCHET

To toggle **RATCHET** on/off for a certain step, hold a step button and then press the **ARP LATCH [TIE]** button. Ratchet causes a step to repeat multiple times within a single step-duration. You can set the ratchet multiple from 1x (no repeats) to 8x. The **RATCHET CNT** multiple can be edited in the **PRESET EDIT / SEQUENCER** sub menu.

***NOTE:** **RTCHT CT** is also a **MOD** destination.*

There is also a panel button-combo to change **RATCHET CNT**. Hold the **BANK** button and press **ARP BACK/FORTH** to decrease, or hold the **BANK** button and press the **ARP INVERT** button to increase the ratchet multiple.

***NOTE:** The **RATCHET CNT** multiplier is universal for the entire sequence. You cannot have different Ratchet Counts per step, however, you can assign the **SEQ MOD** value (see below) directly to the **RTCHT CT** parameter so that every step can, effectively, have its own Ratchet Count.*

TRY THIS: Go to **GLOBAL MENU > CV MAPPING** and map **VOLUME** to **RTCHT CT**. Now, plug a Foot Controller with a TRS plug into the **VOL CV** jack on the left side of the Subsequent 37. Toggle Ratchet On for some (or all) of your steps. Now you can sweep the Ratchet count on those Ratcheted steps from 1x to 8x, in real time.

SEQ MOD VALUES W/ MOD WHEEL

Whether you are recording a sequence in step time, or editing a step, the current position of the **MOD WHEEL (SEQ MOD** value) is recorded for each step. These per-step **SEQ MOD** values can be used in two ways: directly via the **MOD DST** parameter, and as a **MOD 1** or **MOD 2 SOURCE** (the source is called **SEQ MOD**).

The **SEQ MOD** values can be assigned to a specific parameter via the **PRESET EDIT > SEQUENCER > MOD DST** parameter. The amount of modulation to the specified **MOD DST** can be scaled using the **SEQ MOD AMT** parameter directly below the **MOD DST** parameter. The **SEQ MOD AMT** parameter values go from **OFF (0%)** to **100%**. The total amount of modulation can also be scaled by the **MOD WHEEL** during sequence playback by setting the **MODWHL CTRL** parameter to **ON**.

It is crucial to understand that the **SEQ MOD** values are bi-polar, meaning that when the **MOD WHEEL** is all the way down, it records a value of **-100%**. When the **MOD WHEEL** is all the way up, it records a value of **+100%**. When the **MOD WHEEL** is centered, it records a **SEQ MOD** value of **0%** (and has no effect on the destination).

It is equally important to understand that the bi-polar **SEQ MOD** value is added to the current setting of whatever parameter it is modulating. For example, if the **MOD DST** is **OSC2 LEV**, and the **OSC 2** value in the **MIXER** section is set to 5, then the bi-polar **SEQ MOD** values could move the **OSC 2** level to either silence or to full volume. But, if the **OSC 2** value in the **MIXER** was set to 0, then the bi-polar **SEQ MOD** values would have no effect on the **OSC 2** level until those values were greater than 0. This is a complex tool, and should be explored in simple settings to fully appreciate its function and applications.

Rests, Ties, Seq Start, Seq End, Ratcheted and Skipped steps, as well as the **SEQ MOD** values, are all saved with each sequence.

SEQUENCE QUICK-ERASE

Hold **BANK** while turning the **PATTERN** knob to the **REC** position. If the sequence is stopped it will be completely erased. If the sequence is running, it will continue to run and the sequence length (number of steps) will remain the same, but all of the steps will be blank (silent).

GLIDE SECTION

Glide, also called portamento or glissando, is used to cause smooth changes in pitch between notes.

TIME

Use this knob to specify how much time it takes to transition from one pitch to the next when you play the keyboard.

OSC

The **OSC** button assigns the glide effect to Oscillator 1, Oscillator 2, or Both Oscillators at the same time. The LEDs marked 1 and 2 will indicate which oscillators have glide assigned to them.

TYPE

Use the **TYPE** button to choose from three different types of glide: linear constant rate (LCR), linear constant time (LCT), and exponential (EXP).

LCR: The glide rate will depend on the size of the interval between notes. The larger the interval, the longer the glide time will be. This is the most commonly used type of glide.

LCT: The glide time will stay the same between notes, regardless of the interval.

EXP: The glide rate follows an exponential curve that begins with a fast rate and slows as it approaches the target note.

GATED

Activating **GATED** glide causes the gradual gliding between notes to be started and stopped by the keyboard gate. When the **GATED** button is illuminated, the pitch CV only glides while a key is held. When the **GATED** button is off, the pitch CV will continue gliding to the target pitch at the current glide rate, regardless of whether or not a key is held on the Subsequent 37. The different behaviors are more distinct at longer glide times.

LEGATO GLIDE

Although glide is normally applied to every note you play when engaged, the **LEGATO GLIDE** function causes glide to occur only when you press a key while still holding a previous key. **LEGATO** and **ON** must both be illuminated for **LEGATO GLIDE** to take effect.

GLIDE ON

Pressing the **ON** button allows you to engage or disengage the glide effect without having to change your **GLIDE TIME** setting. This button must be illuminated for the glide effect to occur.

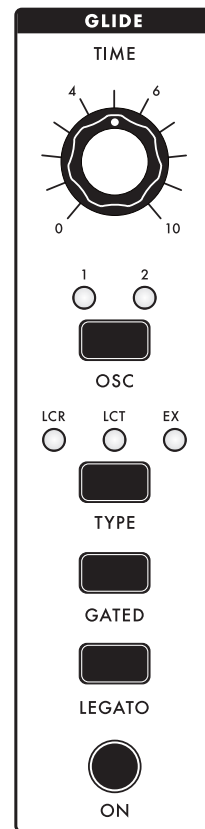

MODULATION

Controlling modulation (abbreviated as **MOD**) is an important aspect of programming and playing synthesizers. When you modulate a synthesizer's audio signal, you are changing something about the way it sounds. When you modulate a control signal, you are changing something about its effect on whatever it's controlling. Synthesizers route their control signals from modulation sources to modulation destinations. On the Subsequent 37, a changing control signal can modulate pitch, filter cutoff, waveform shape, VCA level, LFO rate, noise level, EG time, and a variety of additional destinations available via the **PRESET EDIT MENU**.

The Subsequent 37 has two modulation busses labeled **MOD 1** and **MOD 2**. They are nearly identical except that, by default, the overall depth of **MOD 1** is determined by the **MODULATION** wheel. You can access and edit this, and other extended modulation parameters by pressing the **CONTROLLERS** button.

Low-frequency oscillators generate repeating waveforms in the sub-audio frequency range. The Subsequent 37's LFOs also have a **HI RANGE** button, which allows the LFOs to generate frequencies well into the audio range as well. At sub-audio rates, the LFOs are useful for generating repeating effects. At audio rates, the LFOs add harmonic complexity to their destinations.

When an LFO modulates an oscillator's frequency, the oscillator's pitch follows the shape of the modulating waveform. If the LFO's output is a triangle wave, the pitch rises and falls at a regular rate. At the proper rate and depth, this type of modulation is called vibrato. Many performers rely on vibrato to add expression to their performances. A violinist or guitarist employs vibrato with a shaking motion of the hand as it applies pressure to the string. A singer subtly fluctuates their vocal pitch. A synthesist uses an LFO to modulate an oscillator's frequency. The **LFO RATE** knob controls the rate of modulation, and the **MODULATION** wheel controls its depth.

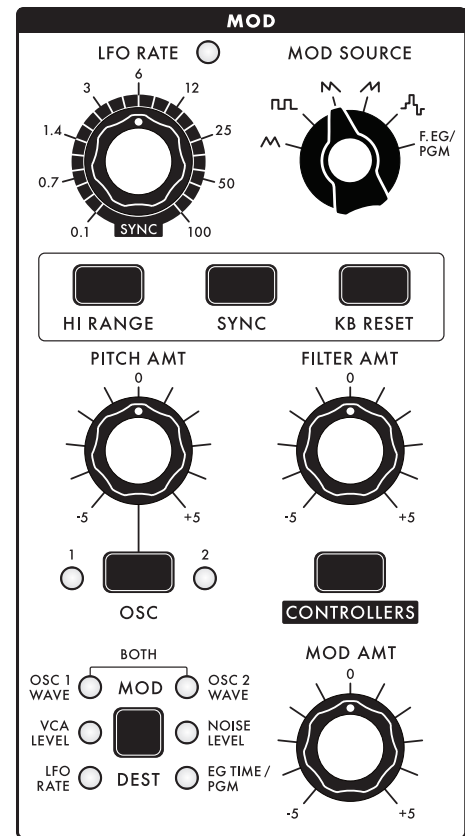

MODULATION CONTROLS

LFO RATE

By default, the **LFO RATE** knob varies the low-frequency oscillator's modulation rate from 0.1Hz (one cycle every 10 seconds) to 100Hz (100 cycles per second). This can be multiplied 10x by using the **HI RANGE** button.

SOURCE

Use this knob to specify whether the modulation source is one of 5 LFO waveforms, the filter envelope, or a programmed source. At its most counterclockwise position, the LFO generates a triangle wave, which is particularly useful for vibrato. Turning the knob clockwise, the next position generates a square wave, which is useful for performing trills and tremolo effects. The next two positions generate sawtooth and ramp (reverse sawtooth) waves. Applied to pitch, sawtooth-wave modulation is useful for simulating alarms, ray guns, and other ascending and descending effects. The fifth position uses sample-and-hold as a modulation source. Think of sample-and-hold as a source of random control signals. (Think 1970's Hollywood sound effects of a computer "thinking".)

When **SOURCE** is set to **F. EG/PGM**, the LFO is bypassed and by default, the filter's envelope settings are used as a source of modulation. A variety of additional modulation sources are also available to you by pressing the **CONTROLLERS** button. To learn more about the **MOD CONTROLLERS** menu, go to page 50.

MODULATION CONTROLS (CONTINUED)

HI RANGE

When engaged, the rate of the LFO is increased by 10x. In this mode, the LFO range is from 1Hz (one cycle per second) through 1,000Hz (1,000 cycles per second).

NOTE: No matter which range you choose, modulation at normal vibrato rates (between 5 and 10Hz) is possible.

SYNC

When the **SYNC** button is illuminated, the LFO rate is synchronized to the Subsequent 37's internal clock, or external MIDI clock. In this mode, the **LFO RATE** knob selects between clock divisions of the internal or external MIDI clock.

KB RESET

When the Keyboard LFO Reset button is illuminated, the LFO will restart its cycle at zero each time a new note is played. With **KB RESET** off, the LFO will run freely, and will not reset at the start of any notes.

PITCH AMT

Use this knob to specify the depth of pitch modulation applied to Oscillator 1, Oscillator 2, or Both of the oscillators. The **PITCH AMT** knob is bipolar, meaning that its control value is positive when turned up beyond 12 o'clock, and negative (or inverted) when turned down below 12 o'clock.

OSC

The **OSC** button is directly tied to the **PITCH AMT** knob, and is used to toggle between modulating the pitch of oscillator 1 only, oscillator 2 only, or modulating both oscillator 1 and oscillator 2 simultaneously.

FILTER AMT

Use this knob to specify the positive or negative depth of variation applied to the filter's cutoff frequency. Applying LFO modulation to the filter is useful for generating slow filter sweeps, wobbles, and repeating effects. This knob is bipolar, meaning that its control value is positive when turned up beyond 12 o'clock, and negative (or inverted) when turned down below 12 o'clock.

CONTROLLERS

Pressing this button takes you to the **MOD 1** or **MOD 2 CONTROL** menu on the LED display screen. Here you can determine the amount of effect that the **MODULATION** wheel, **VELOCITY**, **AFTERTOUCH**, and an assignable **CONTROLLER 4**, have on the modulation destinations. To learn more about the **MOD CONTROLLERS** menu, got to page 50.

MOD AMT

Use this knob to assign positive or negative amounts of modulation to your selected destination (**DEST**). This knob is bipolar, meaning that its control value is positive when turned up beyond 12 o'clock, and negative (or inverted) when turned down below 12 o'clock.

MOD DEST

This switch toggles through seven various modulation destinations, including LFO rate (of the other LFO), VCA level, oscillator 1 waveshape, oscillator 2 waveshape, both oscillators' waveshapes, noise level, EG times, or other various destinations assigned via the **MOD CONTROLLERS** menu. To learn more about the **MOD CONTROLLERS** menu, got to page 50.

MODULATION CONTROLS (CONTINUED)

LFO RATE

This destination modulates the rate of the other LFO (**MOD 1** modulates the rate of LFO 2; **MOD 2** modulates the rate of LFO 1).

VCA LEVEL

This destination allows you to modulate the amplitude level of the VCA. This is useful for creating tremolo effects at lower LFO rates, and ring modulation effects at higher LFO rates.

OSC 1 WAVE, OSC 2 WAVE, BOTH

When any of these destinations are chosen, modulation is applied to the shape of the oscillator's waveform. As the waveform is modulated, the amplitudes, frequencies, and phase of the harmonics change dynamically. Waveform modulation has no effect on the sub oscillator, which always generates a square wave.

NOISE LEVEL

This destination modulates the noise's mixer volume. This amount is added to or subtracted from the **NOISE** level in the **MIXER** section.

EG TIME/PGM

This destination by default allows you to modulate the relative time of the envelope generator settings, without affecting the envelope shape. A negative modulation amount will cause the envelope time to shorten, while a positive modulation amount will cause the envelope time to lengthen.

This destination is also used in conjunction with the **CONTROLLERS** button to select from an additional variety of programmable modulation destinations. To learn more about the **MOD CONTROLLERS** menu go to page 50.

PERFORMANCE NOTE: You can quickly assign the **PGM** modulation destination by holding the square **MOD (1/2) DEST** button while turning the knob or pressing the button of the parameter you want to set as the mod dest.

OSCILLATORS SECTION

Oscillator 1 and oscillator 2 are the Subsequent 37's primary sound sources. They generate four basic waveforms: triangle, sawtooth, square, and pulse. Since the **WAVE** knob is continuous, you can interpolate between these shapes.

The triangle wave consists of odd-numbered harmonics only. Its fundamental is very strong, and its overtones are very weak, making it less harmonically complex than other waveforms. By mixing a triangle from one oscillator with a more complex wave from the other, you can emphasize one particular harmonic without mucking things up with unwanted overtones.

An unfiltered sawtooth wave is much brighter, because it contains all the natural harmonics. As the harmonics ascend in frequency, they grow weaker in amplitude. Sawtooth waves are useful for synthesizing bass, simulating brass instruments, and more.

Although a pulse wave contains only odd-numbered harmonics, it offers the most flexibility because you can change the balance of those odd-numbered harmonics by changing its shape. Think of a pulse-wave oscillator as a switch you can turn on and off hundreds or thousands of times per second. In a single pulse wave, the "switch" is either on or off. Its pulse width is the proportion of the wave that's on, usually expressed as a percentage. A square wave is simply a pulse wave with 50% pulse width, meaning that in a single cycle, it is on half the time and off half the time. If its frequency is 440Hz, that means it goes on and off 440 times every second, and the result you hear is the pitch A above middle C. Every pulse width has its own characteristic sound, because each has a unique harmonic structure, making a variety of basic timbres possible.

Unlike most synths, which simply switch between basic waveforms, the Subsequent 37 allows you to gradually change the oscillator's output from one waveform to another, so it can generate something partway between a sawtooth and a square wave, for example. We refer to such controls as continuously variable because there are no discrete steps between settings.

In normal operation the keyboard, pitch wheel, arpeggiator, step sequencer, or external MIDI data control oscillator pitch. You can also apply **MOD 1**, and **MOD 2** to modulate oscillator pitch and waveform.

OSCILLATOR CONTROLS

OCTAVE

Use this knob to control either oscillator's pitch range. Pitch range is expressed in feet, a reference to the age of pipe organs, when a pipe's physical length determined its pitch. The Subsequent 37's **OCTAVE** knobs cover four pitch ranges corresponding to four octaves. The lowest setting is 16', and the highest setting is 2'.

WAVE

Use this knob to vary either oscillator's waveform from triangle to sawtooth to square to narrow pulse wave. Turning the **WAVE** knob clockwise from the triangle to sawtooth position increases the oscillator's harmonic content. Continuing to turn it to the square-wave position weakens and then eliminates even-numbered harmonics while strengthening odd-numbered harmonics. Turning it from the square to narrow-pulse position changes its harmonic content further by weakening the overtones relative to the fundamental frequency. This parameter can be modulated via **MOD 1** or **MOD 2** to create interesting harmonic motion.

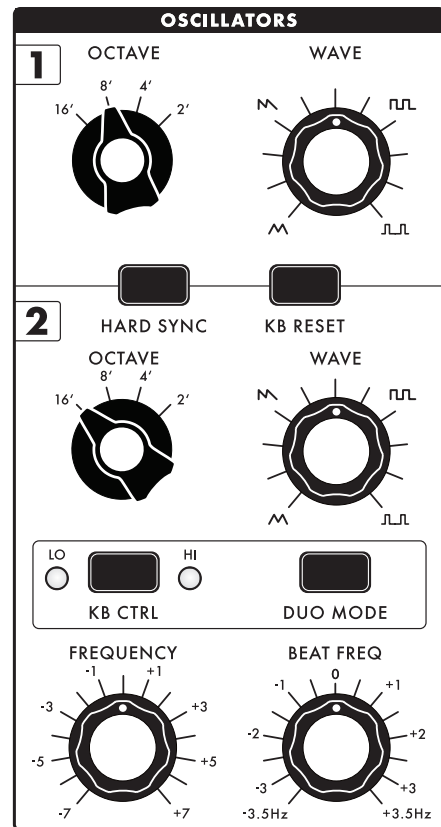

OSCILLATOR CONTROLS (CONTINUED)

HARD SYNC

This button locks oscillator 2's phase to oscillator 1, eliminating any phase differences between them.

When both oscillators are in sync, each time that oscillator 1 begins a new cycle, it forces oscillator 2 to begin its cycle at the same instant, regardless of whether its previous cycle is complete. As a result, hard sync forces oscillator 2's waveform to take on a different shape, typically one with greater harmonic complexity. Because oscillator 2 is in sync with oscillator 1, their combined harmonic content depends on their pitch relationship, so that changing oscillator 2's frequency will have an immediate effect on timbre. For that reason, modulating oscillator 2's frequency opens up some outstanding waveshaping opportunities when **HARD SYNC** is engaged.

NOTE: *If oscillator 1's frequency is higher than oscillator 2's, oscillator 2 will be unable to complete its cycle, resulting in little or no output from oscillator 2.*

KB RESET

When engaged, the keyboard reset function forces the audio oscillators to simultaneously begin their cycles whenever you play a new note. The result is a well-defined leading edge to sounds with a hard attack. This can cause a small click or pop in the sound. To minimize this effect, set a short Release time on the Amp Envelope.

DUO MODE

When **DUO MODE** is engaged, the Subsequent 37 has the ability to control the pitch of OSC 1 independently of OSC 2. This behavior is based on oscillator **KB CTRL** settings.

KB CTRL

This button is used to determine how OSC 2 responds to the keyboard when in **DUO MODE**.

HI: OSC 2 follows the highest note played, while OSC 1 follows the lowest note.

LO: OSC 2 follows the lowest note played, while OSC 1 follows the highest note.

OFF: OSC 2 drones and does not follow the keyboard. The **FREQUENCY** control knob's range is extended to +/- 3 octaves, so you can set a constant pitch for OSC 2 across a wider range.

FREQUENCY

This knob is used to fine-tune oscillator 2's pitch within its selected range. The **FREQUENCY** knob's range is seven semitones lower or higher than its center position. At its center position, oscillator 2 is tuned to oscillator 1. Turning it just slightly out of tune with oscillator 1 can yield interesting detuned or phasing effects. Turning the knob fully clockwise will create a perfect fifth interval against oscillator 1 (assuming that they're both on the same octave) allowing you to play "power chords" with just one finger.

BEAT FREQ: Use the **BEAT** knob to set the beat frequency of oscillator 2 against oscillator 1. The range is plus or minus 3.5Hz with no detuning (0Hz) in the middle. This parameter creates a linear constant detuning of oscillator 2 relative to oscillator 1 so that oscillator 2 is always detuned by the same number of cycles per second (Hz) regardless of the musical pitch. The result is a musical detuning effect which phases or "beats" at a consistent rate on every note.

By contrast, the **OSCILLATOR 2 FREQUENCY** knob detunes oscillator 2 by musical cents, where the rate of beating between oscillators is halved or doubled as you play an octave lower or higher in pitch.

NOTE: *For this reason, if you want a constant beat frequency at all pitches, make sure that the **OSCILLATOR 2 FREQUENCY** control is centered. If you want near-absolute unison between oscillator 2 and oscillator 1, make sure that the **BEAT FREQUENCY** control is also centered.*

MIXER SECTION

The mixer lets you combine audio signals from each of the Subsequent 37's four internal audio sources as well as an external audio source or mixer feedback. Each mixer source has a dedicated knob for controlling its relative level as well as a mute button. The beauty of having dedicated mute buttons is that you can leave an audio source's level at a pre-set amount and instantly bring it in or out with the push of a button. When a level knob is turned fully counterclockwise, its input is effectively turned off. Turning it clockwise from 0 increases the level until it reaches its maximum at 10. Mixer settings higher than 5 will overdrive the input of the filter, meaning that you can specify which sources are distorted and which simply pass through the filter.

MIXER CONTROLS

OSC 1

Use this knob to control oscillator 1's level. Settings higher than 5 push the level beyond unity, imparting gentle filter distortion. A setting of 5 or below delivers a clean signal to the filter.

SUB OSC

Use this knob to control the sub oscillator's level. Settings higher than 5 push the level beyond unity, imparting gentle filter distortion. A setting of 5 or below delivers a clean signal to the filter. The Subsequent 37's sub oscillator is always tuned exactly one octave below oscillator 1's pitch, and its waveform is always a square wave. Typically, the sub oscillator adds a solid foundation to the Subsequent 37's sound. It is especially useful for crafting monstrous Moog bass patches.

OSC 2

Use this knob to control oscillator 2's level. Settings higher than 5 push the level beyond unity, imparting gentle filter distortion. A setting of 5 or below delivers a clean signal to the filter.

NOISE

Use this knob to control the Subsequent 37's pink noise generator level. Settings higher than 5 push the level beyond unity, imparting gentle filter distortion. Noise is useful for programming punchy percussion and other non-pitched sounds.

Whereas an oscillator generates a pitched waveform, noise is a non-pitched sound source. The two most common types of noise are white noise and pink noise. Just as white light contains all colors of the visual spectrum in equal proportion, white noise contains a random distribution of all audible frequencies. Every frequency has equal amplitude. We hear white noise as a constant sssh sound, like an FM radio between stations. Because of the way our brains respond to white noise, the higher frequencies sound more prominent than the lower ones.

The Subsequent 37's noise generator produces a signal called pink noise. Pink noise has equal amplitudes in every octave, making it sound deeper than white noise - more like the sound of a waterfall. Many synthesists consider pink noise more useful than white noise.

FDBK / EXT IN:

When nothing is plugged into the **EXT IN** jack on the left side of the Subsequent 37, the **FDBK / EXT IN** knob takes the output of the mixer and feeds it back into this mixer channel, resulting in a variety of distorted, sometimes chaotic, sometimes mellow qualities.

Warning: This control can increase the output volume considerably!

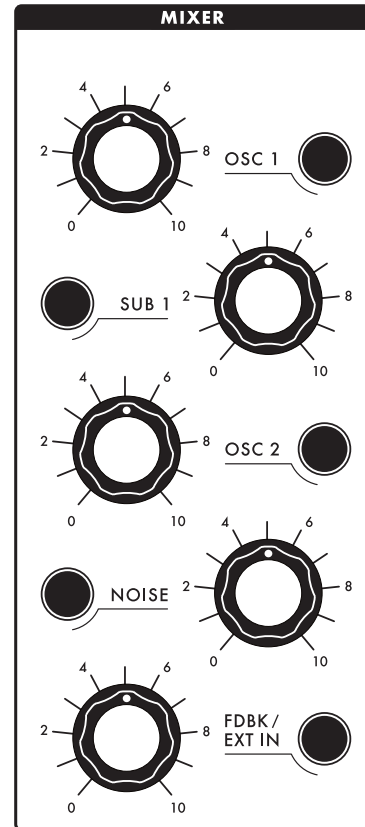

FILTER SECTION

The number and relative strengths of a sound's harmonic frequencies determine its tone color or timbre. The Subsequent 37 contains a filter for removing certain frequencies from audio signals. Because filtering gives you control over an audio signal's harmonic content, it physically alters the waveform being filtered.

The Subsequent 37 has a classic Moog Lowpass Ladder Filter with four selectable slopes. Lowpass filters pass all frequencies up to a point called the cutoff frequency and gradually roll off, or attenuate, frequencies above that point. You can change the cutoff manually using the knob, or you can change it by applying a signal from a control source such as an envelope or LFO.

Turning the cutoff all the way down closes the filter so that nothing passes through it. Raising the cutoff opens the filter. As you turn the **CUTOFF** knob clockwise from its lowest position, first you'll hear only the audio signal's lowest frequencies, and then the timbre will grow gradually brighter. The filter envelope, in combination with the **CUTOFF** knob's setting, is the filter's primary control source.

Another characteristic of the Subsequent 37's filter is resonance. Resonance increases the level of audio frequencies closest to the cutoff frequency by making the filter roll off frequencies less gradually. It regenerates those frequencies by feeding them back to the filter. Turning up the resonance emphasizes harmonics closest to the cutoff frequency and exaggerates any changes to the cutoff frequency.

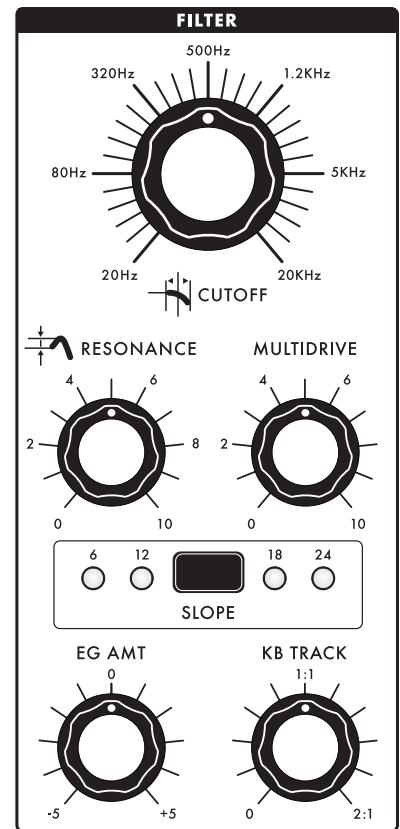

FILTER CONTROLS

CUTOFF

Use this knob to change the filter's cutoff frequency. Its lowest setting is 20Hz, which effectively closes the filter and doesn't allow any audio to pass through. Its highest setting is 20kHz, which opens the filter completely and allows all audio to pass through.

RESONANCE

Use this knob to control how much signal is routed from the filter's output back to its input. Turning it clockwise increases the resonance, causing a peak in amplitude at the cutoff frequency. Settings above 7 cause the filter to self-oscillate.

MULTIDRIVE

MultiDrive is the Subsequent 37's distortion processor, offering effects ranging from asymmetrical, tube-like warmth to aggressive hard clipping, with a smooth continuous transition in between. The **MULTIDRIVE** knob controls how hard you drive the OTA and FET stages, which are located between the filter and the amplifier in the signal path. The higher the setting, the more aggressive the clipping effect. Varying amounts of MultiDrive can give your sounds a distinct tonal edge, as well as make them more responsive to changes in filter resonance, waveform, and oscillator levels.

FILTER CONTROLS (CONTINUED)

SLOPE

Pressing the **SLOPE** button selects between a 1-pole filter slope (-6dB-per-octave), a 2-pole filter slope (-12dB-per-octave), a 3-pole filter slope (-18dB-per-octave), or the classic Moog 4-pole filter slope (-24dB-per-octave). You can also change this setting in real time as you play.

EG AMOUNT

Use this knob to control how much the filter envelope modulates the filter's cutoff frequency. In other words, **EG AMOUNT** controls the depth of the envelope generator's effect on the filter.

The **EG AMOUNT** knob is bipolar, meaning that its control value is positive when it's turned up and negative when it's turned down. Turning it clockwise from center causes the envelope to raise the cutoff frequency from the **CUTOFF** knob's setting. Turning it counterclockwise from center causes the envelope to lower the cutoff frequency from the **CUTOFF** knob's setting. The depth of the envelope's effect on the cutoff frequency also depends a lot on the **CUTOFF** setting. If the setting is very high and you adjust the **EG AMOUNT** to raise it further, then the envelope will have little effect. The lower the cutoff frequency, then the more the envelope will be able to modulate it. On the other hand, if the setting is very low and you adjust the **EG AMOUNT** to lower it further by turning the knob counterclockwise, again, the envelope will have little effect.

KB TRACK

Use this knob to specify how much the filter cutoff tracks the keyboard; that is, how much the keyboard pitch affects the filter's lowpass frequency. With **KB TRACK** turned fully counter clockwise keyboard track will have no effect on the filter's cutoff frequency. With **KB TRACK** turned up halfway, the filter cutoff will follow the keyboard pitch at a 1:1 ratio centered around C3 (MIDI note 48).

KB TRACK at maximum sets a 2:1 ratio for filter keyboard tracking.

ENVELOPES

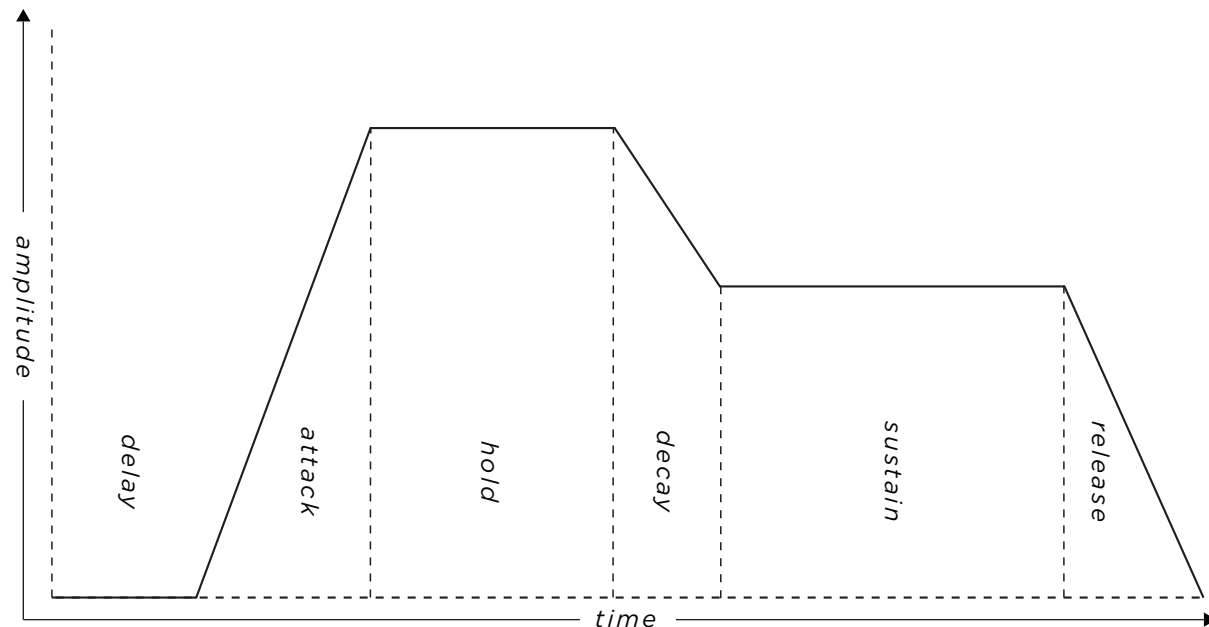

When you make any sound, it may take a moment for that sound to reach its maximum amplitude and brightness. This initial moment is called the sound's attack. An attack may be gradual (like a cymbal roll), abrupt (like a cymbal crash), or anything in between. The attack often tells us more about how an instrument is played than any other characteristic. Likewise, when the sound ends, it may take a

ENVELOPES (CONTINUED)

moment to die away completely, or it may stop suddenly. This final drop in amplitude and brightness is called its release. The attack and release, along with variations in amplitude and timbre that occur between the attack and release, make up the sound's envelope.

The Subsequent 37 shapes electronic sounds using two envelope generators (abbreviated EG). One envelope affects the Subsequent 37's filter, which controls timbre, and the other affects its amplifier, which controls amplitude. When you press a key on the keyboard, it sends a signal that tells the envelope generator to begin the attack. In voltage-controlled synthesizers like the Subsequent 37, this signal is called a gate. The gate ends when you release the key, telling the envelope generator to begin the release.

Both of the Subsequent 37's envelope generators have six stages: delay, attack, hold, decay, sustain, and release (abbreviated DAHDSR). In the default mode, the four front-panel envelope generator knobs are assigned to control the attack, decay, sustain, and release (ADSR). Just as attack is the time it takes a level to peak, the decay is the time it takes to fall to a steady level, called the sustain. The sustain level is held until the key is released. At that point, the signal returns to zero at a rate determined by the release setting. Whereas the attack, decay, and release stages are specified as lengths of time, sustain is a control-signal level.

When you play the Subsequent 37, your keyboard technique determines how the envelope generators respond, which impacts your musical expression and articulation. If you release the key before the envelope reaches either its maximum or sustain level, the release stage immediately takes effect. When you play staccato (very short notes), the envelope may never reach its decay stage, depending on its attack setting. Playing legato—holding down each key for the note's full duration without lifting your fingers between notes—prevents the envelope from retriggering its attack stage on subsequent notes. In that case, the envelope maintains its sustain level until you trigger the release stage by lifting your finger.

When the **KNOB SHIFT** button (between the filter and amplitude attack knobs) is pressed and blinking, the first two envelope generator knobs become **DELAY** and **HOLD** knobs while the third and fourth knobs adjust the amount that keyboard velocity and keyboard tracking affect the envelope amounts.

FILTER ENVELOPE CONTROLS

ATTACK

Use this knob to specify the time it takes the filter frequency to ascend from the **CUTOFF** knob's manual setting to its maximum level, which is determined by the filter's **EG AMOUNT** setting. Its value ranges from 1 millisecond to 10 seconds. When you use the filter envelope to modulate pitch or wave amount, the **ATTACK** knob specifies the time it takes the control level to ascend to its maximum value.

DECAY

Use this knob to specify the time it takes the filter frequency to descend from its maximum level to its sustain level. Its value ranges from 1 millisecond to 10 seconds. When you use the filter envelope to modulate pitch or wave amount, the **DECAY** knob specifies the time it takes the control level to descend from its maximum value to its sustain level.

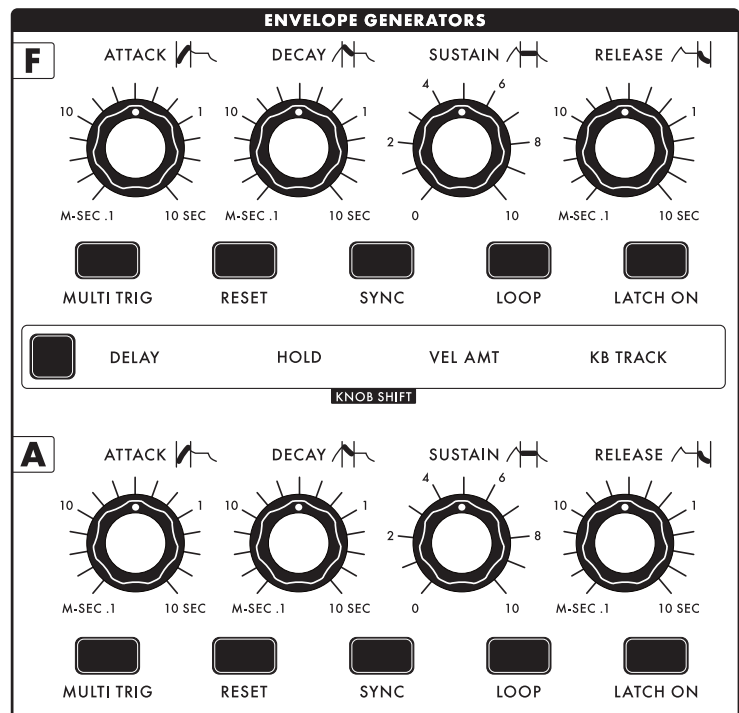

FILTER ENVELOPE CONTROLS (CONTINUED)

SUSTAIN

Use this knob to specify the filter cutoff frequency once the decay stage is complete. The sustain stage is held until the envelope receives a Note Off command or the gate ends. Its value ranges from **0%** to **100%**, calibrated 1 to 10. Note that the filter's **EG AMOUNT** determines the depth of its effect. When you use the filter envelope to modulate pitch or wave amount, the **SUSTAIN** knob specifies the control value that is held once the decay stage is complete.

RELEASE

Use this knob to specify the time it takes the filter cutoff to descend from its current value to the **CUTOFF** knob's manual setting. Its value ranges from 1 millisecond to 10 seconds. When you use the filter envelope to modulate pitch or wave amount, the **RELEASE** knob specifies the time it takes the control level to descend from the current value to zero.

MULTI TRIG

By default, playing legato on the Subsequent 37 prevents envelopes from retriggering on subsequent notes; this is called single triggering. You can change this behavior by pressing the **MULTI TRIG** button. When lit, a new gate occurs each time you play a note on the keyboard, regardless of whether you've released the previous key; this is called multiple triggering.

RESET

By default, with envelope reset turned off, an envelope Attack sweeps the envelope output only from its current level to maximum. When the **RESET** button is lit the Attack starts from minimum regardless of the level at the time of the key press. This effect is more prominent with longer attack and release times.

SYNC

When the **SYNC** button is lit the envelope will retrigger at every unit of the beat. The **FILTER EG CLOCK DIV** parameter in the **PRESET EDIT** menu allows you to determine the clock division at which the envelope will retrigger. (See MIDI Table on page 52 for available units of the beat.)

LOOP

Normally, an envelope occurs just once when you play a note. When **LOOP** is illuminated, an envelope's delay, attack, hold, decay, and release stages will loop continuously for as long as a note is held. Because of this, it is possible to use the filter's envelope generator as a multistage LFO. The shorter the envelope times, the faster the loop will repeat.

LATCH ON

When the **LATCH ON** button is lit the **FILTER ENVELOPE** will remain at its **SUSTAIN** level, as if the gate was on.

FILTER ENVELOPE CONTROLS (KNOB SHIFT ON)

DELAY

When the **KNOB SHIFT** button is blinking you can use the **FILTER ATTACK** knob (now **FILTER DELAY**) to specify a timed pause before the onset of the filter envelope's attack, effectively turning the ADSR envelope into a DADSR envelope. To increase the time before the onset of attack, engage the **KNOB SHIFT** button and turn up the filter envelope's **ATTACK** knob. The envelope's delay time ranges from a minimum of 0 millisecond to a maximum of 10 seconds.

FILTER ENVELOPE CONTROLS (KNOB SHIFT ON) (CONTINUED)

HOLD

When the **KNOB SHIFT** button is blinking you can use the **FILTER DECAY** knob (now **FILTER HOLD**) to add a hold stage to the filter envelope allowing you to specify a fixed delay between the attack and decay stages, effectively turning an ADSR envelope into an AHDSR envelope. During this stage, the filter's cutoff frequency is held at its maximum level, which is determined by the filter's **EG AMOUNT** setting. To increase the hold time before the onset of envelope's decay, engage the **KNOB SHIFT** button and turn up the filter envelope's **DECAY** knob. You can vary the envelope's hold time from a minimum of 0 to a maximum of 10 seconds.

VEL AMT

When the **KNOB SHIFT** button is blinking you can use the **FILTER DECAY** knob (now **FILTER VELOCITY AMOUNT**) to make your sounds get darker as you press the keys slower on the keyboard, and brighter as you press the keys faster. The knob's range varies from **0%** to **100%**. Note that the highest velocity always gives the full amount, and that higher knob values affect the softer velocities, which makes them deliver lower amounts.

KB TRACK

When the **KNOB SHIFT** button is blinking you can use the **FILTER RELEASE** knob (now **FILTER KEYBOARD TRACKING AMOUNT** knob) to specify how much keyboard tracking affects the filter envelope's decay and release times. To change the decay and release times in response to where you play on the keyboard, engage the **KNOB SHIFT** button and turn the filter envelope's **RELEASE** knob. The knob's range is 0 to 2:1 with 1:1 tracking at 12 o'clock. As you turn the knob clockwise you will shorten the envelope times as you go higher up the keyboard.

AMPLIFIER ENVELOPE CONTROLS

ATTACK

Use this knob to specify the time it takes the mixer output's amplitude to ascend from zero to its maximum value. Its value ranges from 1 millisecond to 10 seconds.

DECAY

Use this knob to specify the time it takes the mixer output's amplitude to descend from its maximum level to its sustain level. Its value ranges from 1 millisecond to 10 seconds.

SUSTAIN

Use this knob to specify the mixer output's amplitude once the decay stage is complete. The sustain stage is held until the envelope receives a Note Off command or the gate ends. Its value ranges from 0% to 100%, calibrated 1 to 10.

RELEASE

Use this knob to specify the time it takes the mixer output's amplitude to descend from its current value to zero after a key is released or the gate is turned off. Its value ranges from 1 millisecond to 10 seconds.

MULTI TRIG

By default, playing legato on the Subsequent 37 prevents envelopes from retriggering on subsequent notes; this is called single triggering. You can change this behavior by pressing the **MULTI TRIG** button. When illuminated, a new gate occurs each time you play a note on the keyboard, regardless of whether you've released the previous key; this is called multiple triggering.

RESET

By default, with envelope reset turned off, an envelope Attack sweeps the envelope output only from its current level to maximum. When the **RESET** button is lit the Attack starts from minimum regardless of the level at the time of the key press. This effect is more prominent with longer attack and release times.

AMPLIFIER ENVELOPE CONTROLS (CONTINUED)

SYNC

When the **SYNC** button is lit the envelope will restart at every unit of the beat. The **AMP EG CLOCK DIV** parameter in the **PRESET EDIT** menu allows you to determine the clock division at which the envelope will reset. (See MIDI Table on page 52 for available units of the beat.)

LOOP

Normally, an envelope occurs just once when you play a note. When **LOOP** is illuminated, an envelope's delay, attack, hold, decay, and release stages will loop continuously for as long as a note is held. Because of this, it is possible to use the amp's envelope generator as a multistage LFO. The shorter the envelope times, the faster the loop will repeat.

LATCH ON

When the **LATCH ON** button is illuminated, the **AMPLIFIER ENVELOPE** will remain at its **SUSTAIN** level as if the gate was on.

AMPLIFIER ENVELOPE CONTROLS (KNOB SHIFT ON)

DELAY

When the **KNOB SHIFT** button is blinking you can use the **AMP ATTACK** knob (now **AMP DELAY**) to specify a timed pause before the onset of the amplifier envelope's attack, effectively turning an ADSR envelope into a DADSR envelope. To increase the time before the onset of attack, engage the **KNOB SHIFT** button and turn up the amplifier envelope's **ATTACK** knob. The envelope's delay time ranges from a minimum of 0 millisecond to a maximum of 10 seconds.

NOTE: The delay parameter for the **AMPLIFIER ENVELOPE** only works when envelope **LOOP** is **ON**.

HOLD

When the **KNOB SHIFT** button is blinking you can use **AMP DECAY** knob (now **AMP HOLD**) to add a hold stage to the amplifier envelope allowing you to specify a fixed delay between the attack and sustain stages, effectively turning an ADSR envelope into an AHDSR envelope. During this stage, the amplifier's amplitude is held at its maximum level, which is determined by the mixer settings. To increase the hold time before the onset of envelope's decay, engage the **KNOB SHIFT** button and turn up the amplitude envelope's **DECAY** knob. You can vary the envelope's hold time from a minimum of 0 to a maximum of 10 seconds.

VEL AMT

When the **KNOB SHIFT** button is blinking you can use the **AMP SUSTAIN** knob (now **AMP VELOCITY AMOUNT**) to make your sounds get quieter as you press the keys slow on the keyboard, and louder as you press the keys faster. The knob's range varies from **0%** to **100%**. Note that the highest velocity always gives the full amount, and that higher knob values affect the softer velocities, which makes them deliver lower amounts.

KB TRACK

When the **KNOB SHIFT** button is blinking you can use the **AMP RELEASE** knob (now **AMP KEYBOARD TRACKING AMOUNT** knob) to specify how much keyboard tracking affects the amplifier envelope's decay and release times. To change the decay and release times in response to where you play on the keyboard, engage the **KNOB SHIFT** button and turn the amplitude envelope's **RELEASE** knob. The knob's range is 0 to 2:1 with 1:1 tracking at 12 o'clock. As you turn the knob clockwise you will shorten the envelope times as you go higher up the keyboard.

OUTPUT SECTION

VOLUME

This knob is the main volume control for the **AUDIO OUT** jack on the left side of the Subsequent 37. Rotating the control fully clockwise produces the maximum output. Rotating the control fully counterclockwise silences the Subsequent 37. A volume setting can be stored with each preset. The **PRESET VOLUME** parameter is located in the **PRESET EDIT** menu. Learn more about this on page 42. If it is set to **OFF** the volume remains at whatever value the knob is left at regardless of which preset is selected.

NOTE: The **PRESET VOLUME** parameter is independent of the **MASTER VOLUME** knob.

MUTE

This button controls the audio that appears at the **AUDIO OUT** jack. This switch has no effect on the **HEADPHONES** jack. This arrangement allows you to monitor and adjust the sound of the Subsequent 37 using headphones, while silencing the signal at the **AUDIO OUT** jack. You can also use the **MUTE** button to turn off the output if you are using the Subsequent 37 as a controller and wish to control external gear without hearing the Subsequent 37. The output is muted when this button is illuminated.

HEADPHONES VOLUME

This control balances the level of the headphones jack with the main **VOLUME** setting. If you change the level of the main **VOLUME** knob, you will hear a similar change in the headphones volume.

HEADPHONES

The **HEADPHONE** jack is a 1/4" TRS headphone output for use with standard headphones. Although it will drive both sides of the headphones it is still a monaural signal as it is identical on both sides.

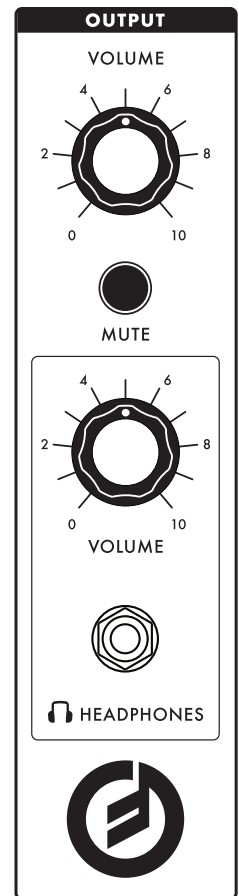

MIDI MENU

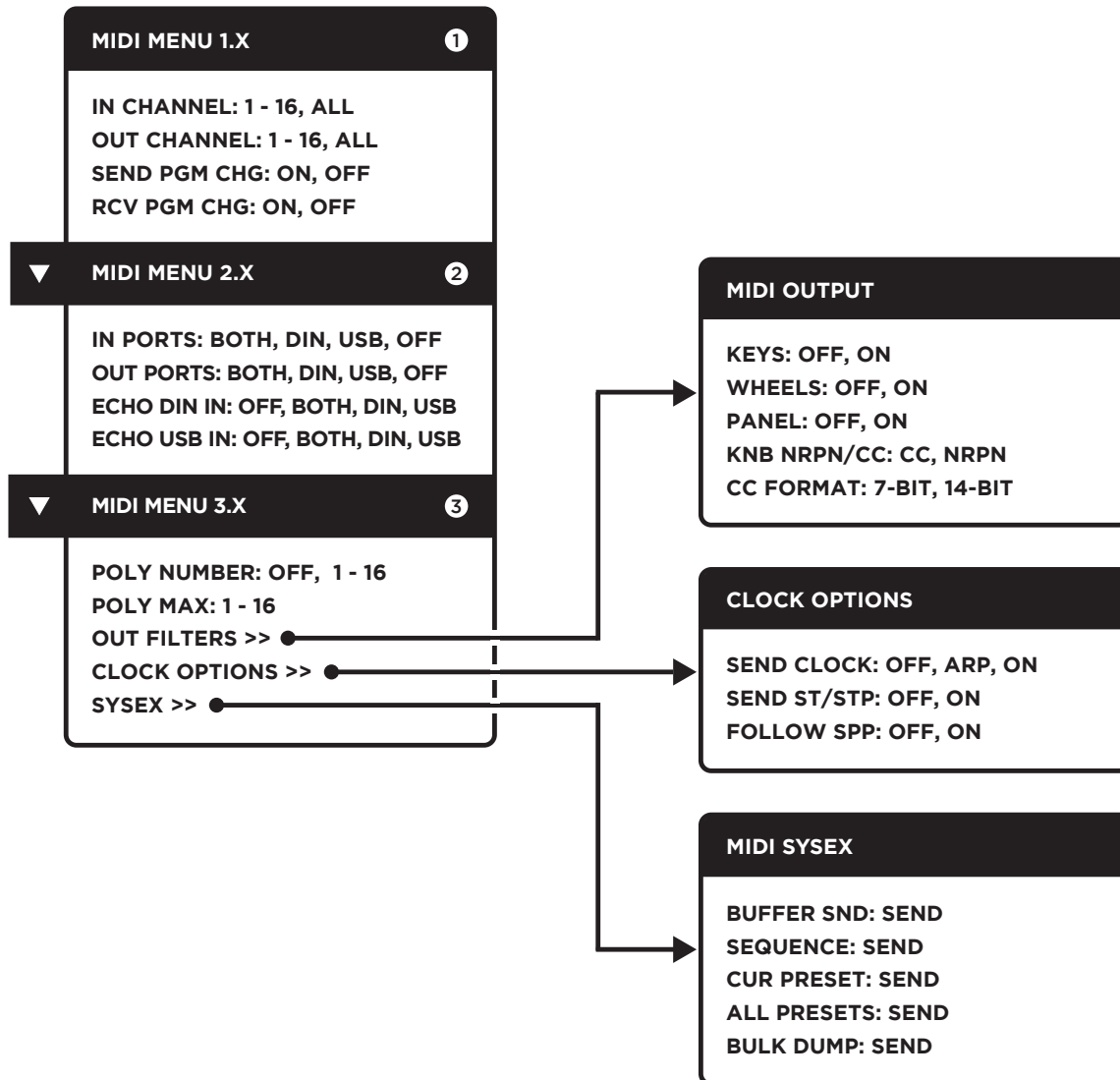

Press the **MIDI** button to open the **MIDI MENU**. This menu contains parameters associated with the sending and receiving of MIDI signals. When the **MIDI** button is illuminated the top right of the LED display will indicate which page you are on, followed by a decimal point, and then which parameter line you currently have selected. Use the ▼ ▲ buttons to choose a parameter for editing, and the **FINE TUNE** knob to scroll through a selected parameter's available options.

NOTE: You can also use the **CURSOR** button to select a parameter and the ▼ ▲ buttons to step through the selected parameter's available options. To exit a parameter, simply press **CURSOR** again.

If more than one page of parameters exists, continuing to press the ▼ button will take you through the additional parameters and pages. If the **MENU WRAP** parameter (**GLOBAL MENU**) is **OFF**, the ▼ button will stop working at the last parameter of the last page.

SUB MENU PARAMETERS

Some parameter types have multiple sub parameters, which are indicated by ">>". If you have one of these menu titles highlighted, you can jump to the sub menu by pressing the **CURSOR** button. To exit a sub menu highlight the "(BACK)<<" parameter and press the **CURSOR** button. This will take you back to the previous menu.

MIDI MENU PARAMETERS

IN CHANNEL (MIDI MENU 1.1)

This determines the Subsequent 37's MIDI Receive Channel. The choices are **1 - 16** and **ALL** which puts the Subsequent 37 in Omni Mode. The default MIDI In channel is **1**.

OUT CHANNEL (MIDI MENU 1.2)

This determines the Subsequent 37's MIDI Transmit Channel. The choices are **1 - 16**. The default MIDI Out channel is **1**.

SEND PGM CHG (MIDI MENU 1.3)

This determines if MIDI Program Changes are sent from the Subsequent 37 to other devices. The choices are **ON** (default) and **OFF**.

RCV PGM CHG (MIDI MENU 1.4)

This determines if MIDI Program Changes sent from external devices are received by the Subsequent 37. The choices are **ON** (default) and **OFF**.

IN PORTS (MIDI MENU 2.1)

This determines which MIDI ports receive MIDI data sent from other devices. The choices are **OFF**, **DIN**, **USB**, or **BOTH** (default).

OUT PORTS (MIDI MENU 2.2)

This determines which MIDI ports transmit MIDI data sent from the Subsequent 37 to other devices. The choices are **OFF**, **DIN**, **USB**, or **BOTH** (default).

ECHO DIN IN (MIDI MENU 2.3)

This parameter takes incoming MIDI data from the 5-pin DIN MIDI Input jack and merges it with the data being sent from the Subsequent 37 to the selected MIDI OUT port(s). This allows the MIDI Output (5-pin DIN and/or USB) to also act as a MIDI THRU. The choices are **OFF** (default), **DIN**, **USB**, or **BOTH**.

ECHO USB IN (MIDI MENU 2.4)

This parameter takes incoming MIDI data from the USB PORT and merges it with the data being sent from the Subsequent 37 to the selected MIDI OUT port(s). This allows the MIDI Output (5-pin DIN and/or USB) to also act as a MIDI Merge. The choices are **OFF** (default), **DIN**, **USB**, or **BOTH**.

POLY NUMBER (MIDI MENU 3.1)

This parameter specifies the Subsequent 37 as a single polyphonic voice for use with other compatible Moog synthesizers. Additional synthesizers must be connected via MIDI in order to add polyphony. No two synthesizers should be assigned to the same voice. When no other synthesizers are connected, this value should be set to **OFF**.

POLY MAX (MIDI MENU 3.2)

This parameter specifies the number of connected voices in a poly chain. This number should not exceed the number of connected units. The default is **3**.

OUT FILTERS (MIDI MENU 3.3)

Highlight **OUT FILTERS >>** and press the **CURSOR** button to enter the **OUT FILTERS** sub menu.

KEYS

When set to **ON** (default) the keys transmit MIDI note data including channel pressure (aftertouch) messages. When set to **OFF** this data is not transmitted.

WHEELS

When set to **ON** (default) the Pitch Bend and Mod Wheel MIDI data is transmitted. When set to **OFF** this data is not transmitted.

MIDI MENU PARAMETERS (CONTINUED)

OUT FILTERS (CONTINUED)

PANEL

When set to **ON** (default) MIDI data from all the panel knobs and buttons is transmitted. When set to **OFF** this data is not transmitted.

KNB NRPN/CC

Determines if the knobs and buttons on the Subsequent 37's panel are transmitted via MIDI as Non Registered Parameter Numbers or as CC messages. The choices are CC (default) and NRPN.

CC FORMAT

Chooses whether Continuous Controller data is sent using 7-bits or 14-bits (for greater precision). If this level of MIDI precision is not needed, use 7-bit (default) as it requires less MIDI bandwidth.

CLOCK OPTIONS (MIDI MENU 3.4)

Highlight **CLOCK OPTIONS >>** and press the **CURSOR** button to enter the **CLOCK OPTIONS** sub menu.

SEND CLOCK

Dictates when the Subsequent 37 sends MIDI clock. **OFF** never sends MIDI clock. **ARP** sends MIDI clock only when the Arp or Seq is running. **ON** sends MIDI clock all the time.

SEND ST/STP

When **ON** (default) MIDI Start and Stop messages are sent when starting and stopping the sequencer. When **OFF** the Subsequent 37 will not send MIDI Start and Stop messages.

FOLLOW SPP

When **ON** the Subsequent 37 will follow the MIDI Song Position Pointer if MIDI Sync is active. **MIDI SPP** allows a DAW to set the sequencer step to match the DAW's song position, so that you can start from beats other than the first beat and (in theory) stay in sync.

SYSEX (MIDI MENU 3.5)

Highlight **SYSEX >>** and press the **CURSOR** button to enter the **SYSEX** sub menu.

NOTE: During a SysEx dump the MIDI button will blink red until the transmission is finished.

BUFFER SEND

This command will send a MIDI SysEx Dump of the edit buffer's current settings (this is the preset or newly created sound as you have currently edited it, not the stored preset). To send the buffer's settings, press the **CURSOR** button highlighting the **SEND** parameter, and then press either of the ▼ ▲ buttons to start the MIDI dump.

NOTE: When you send this type of SysEx file into a Subsequent 37, the data will go into its edit buffer, but not yet be stored into a Preset location. You will still have go through the **SAVE** procedure as outlined on page 13, which allows you to choose where you want to save this newly loaded Preset.

SEQUENCE SEND

This command will send a MIDI SysEx Dump of the edit buffer's current sequence data (this is the sequence as you have currently edited it, not the stored sequence). To send the buffer's sequence data, press the **CURSOR** button highlighting the **SEND** parameter, and then press either of the ▼ ▲ buttons to start the MIDI dump.

NOTE: When you send this type of SyEx file into a Subsequent 37, the data will go into its edit buffer, but not yet be stored into a Preset location. You will still have go through the **SAVE** procedure as outlined on page 13. The advantage of this is that you can send Sequence dumps to any preset without overwriting the saved preset's sequence. To permanently save the sequence, just save the preset.

CURRENT PRESET

This command will send a MIDI SysEx Dump of the currently selected Preset's settings. To send the current Preset's settings, press the **CURSOR** button highlighting the **SEND** parameter, and then press either of the buttons to send the MIDI data.

WARNING: *When you send this type of SysEx file into any Subsequent 37 the Preset will automatically be stored to the current Preset location. Loading a SysEx file like this WILL overwrite the Preset in that particular location. Always back up your Presets before loading others' SysEx files.*

ALL PRESETS

This command will send a MIDI SysEx Dump containing the settings of all 256 of the Subsequent 37's onboard Presets. To send all Presets, press the **CURSOR** button highlighting the **SEND** parameter, and then press either of the ▼ ▲ buttons to send the MIDI data.

WARNING: *When you send this type of SysEx file into any Subsequent 37 the Presets will automatically be stored to all of the locations they were at when the SysEx was originally dumped. Loading a SysEx file like this WILL overwrite any Presets at those particular locations. Always back up your Presets before loading others' SysEx files.*

BULK DUMP

This command will send a MIDI SysEx Dump containing the settings of everything in the Subsequent 37, including presets, MIDI, and global settings. To send all data, press the **CURSOR** button highlighting the **SEND** parameter, and then press either of the buttons to send the MIDI data.

NOTE: *When you send this type of SysEx file into any Subsequent 37, all existing **MIDI MENU** and **GLOBAL MENU** settings will be overwritten by the settings contained in this SysEx file, and all Presets will be stored in the locations they were at when the SysEx was originally dumped. Always back up your Presets and system settings before loading others' SysEx files.*

PRESET MENU

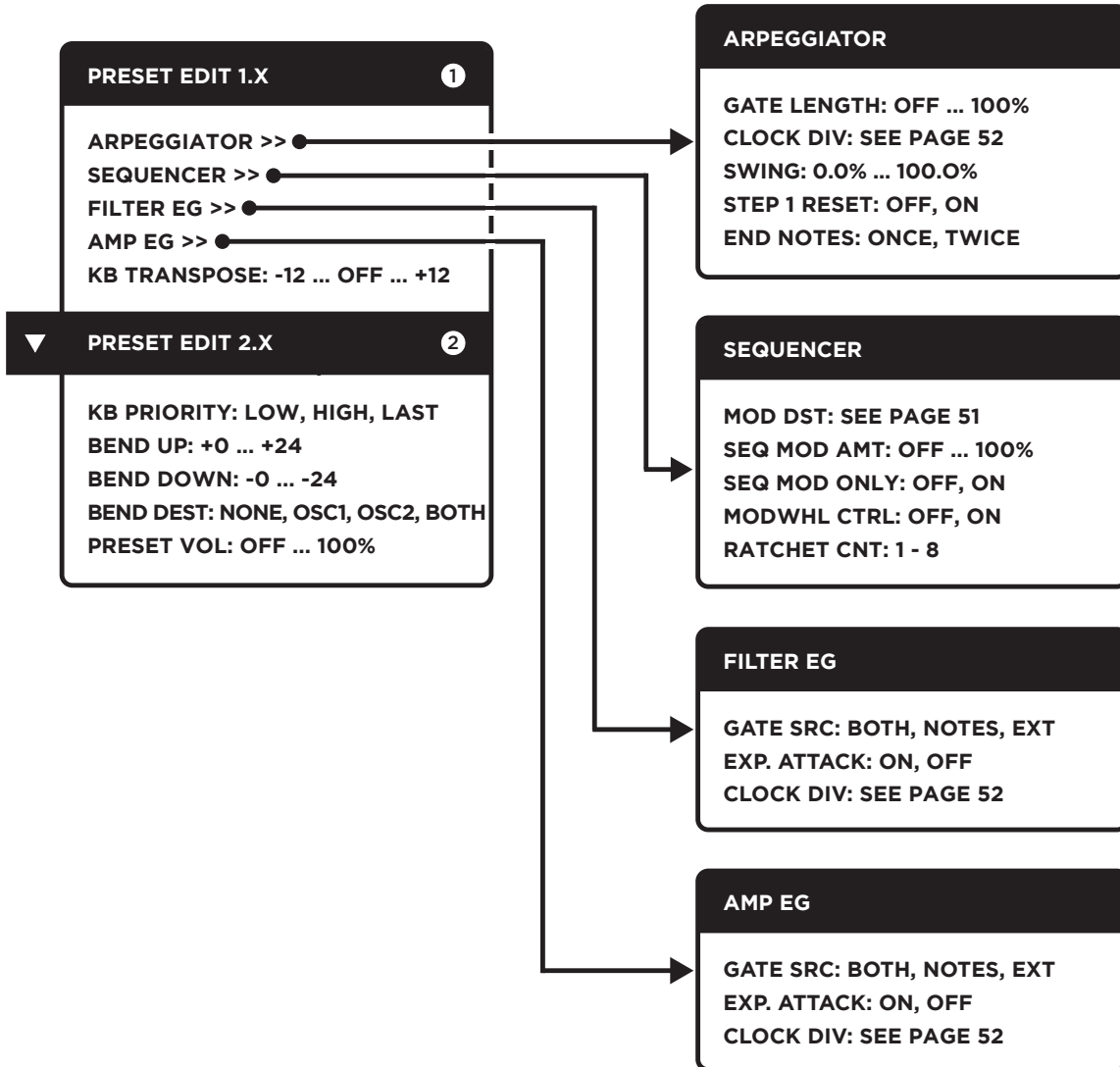

To enter the Subsequent 37's **PRESET EDIT MENU** press and hold the **PRESET** button for one second. This menu contains per-preset parameters that are not represented by the front panel knobs and buttons. The top right of the LED display will indicate which page you are on, followed by a decimal point, and then which parameter line you currently have selected. Use the ▼ ▲ buttons to choose a parameter for editing, and the **FINE TUNE** knob to scroll through a selected parameter's available options.

NOTE: You can also use the **CURSOR** button to select a parameter and the ▼ ▲ buttons to step through the selected parameter's available options. To exit a parameter, simply press **CURSOR** again.

If more than one page of parameters exists, continuing to press the ▼ button will take you through the additional parameters and pages. If the **MENU WRAP** parameter (**GLOBAL MENU**) is **OFF**, the ▼ button will stop working at the last parameter of the last page.

SUB MENU PARAMETERS

Some parameter types have multiple sub parameters, which are indicated by ">>". If you have one of these menu titles highlighted, you can jump to the sub menu by pressing the **CURSOR** button. To exit a sub menu highlight the **"(BACK)<<"** parameter and press the **CURSOR** button. This will take you back to the previous menu.

PRESET EDIT MENU PARAMETERS

ARPEGGIATOR (PRESET EDIT 1.1)

Highlight **ARPEGGIATOR >>** and press the **CURSOR** button to enter the **ARPEGGIATOR** sub menu.

GATE LENGTH

This parameter specifies how long the arpeggiator's gate stays on for each note. The default is **50%**, which means that each note of an arpeggiation is held for half of the length of that note. After 50% of the time has passed, the filter and amplitude envelopes will go into the release portion of their envelope settings. The available range is from **OFF** (no gate at all) to **100%** (all notes are played legato with no space in between).

CLOCK DIV

This determines the arpeggiator's note relationship to the internal or MIDI clock. The first value is 4, which means a single arpeggiation note is 4 whole notes long (384 MIDI clocks). The highest value is 1/64T, which means that each arpeggiation note is a 1/64th-note triplet (1 MIDI clock). Please refer to the chart on page 52 for a list of available clock divisions.

SWING

This parameter allows you to "swing" your sequence data. The range is from **0%** to **100%**. When **SWING** is set to **50%** (default) all quarter notes are played with equal time (or "straight"). When **SWING** is set to a value below **50%**, it will move the off-beats earlier in time. When **SWING** is set to a value above **50%**, it will move the off-beats later in time. At **0%** swing, only the off-beats will play; at **100%** swing, only the on-beats will play.

***NOTE:** Each of the **CONTROLLER** edit pages for **MOD BUS 1** and **MOD BUS 2** have a parameter called **LFO1 SWING (OFF/ON)** and **LFO2 SWING (OFF/ON)**, respectively. When these are set to **ON** (default) and when **SYNC** for that **LFO** is **ON**, the respective **LFO** will swing in accordance with the **SWING** value set above.*

STEP 1 RESET

This is used to determine the behavior of the various **KB RESET** parameters (**MOD 1 & 2**, Oscillators) when the Arpeggiator is running. If **STEP 1 RESET** is **ON**, then **KB RESET** will only occur on the first note of the arpeggiator pattern or sequence. If **STEP 1 RESET** is **OFF**, then **KB RESET** will happen on every note of the arpeggiation or sequence.

END NOTES

This parameter is only valid when the **BACK/FORTH** button is illuminated. It determines if the beginning and ending notes of an arpeggiation are played once or twice during the turnaround.

***EXAMPLE:** If you're arpeggiating C-E-G using the **UP** Pattern with the **BACK/FORTH** button illuminated, you get C-E-G-E-C etc. if you choose **ONCE**. If you choose **TWICE** you'll get C-E-G-G-E-C-C etc.*

SEQUENCER (PRESET EDIT 1.2)

Highlight **SEQUENCER >>** and press the **CURSOR** button to enter the **SEQUENCER** sub menu.

MOD DST

This is a dedicated mod destination for the sequencer. The position of the **MOD WHEEL** is recorded for each step in a sequence as a bi-polar value (with the **MOD WHEEL** centered equaling 0). You can use the **MOD DST** parameter to directly assign the **SEQ MOD** values to virtually any parameter in the Subsequent 37. The default is **OFF**.

SEQ MOD AMT

This parameter scales the amount of sequence modulation to a selected destination. The values range from **OFF** (default) to **100%**.

PRESET EDIT MENU PARAMETERS (CONTINUED)

SEQUENCER (PRESET EDIT 1.2) (CONTINUED)

SEQ MOD ONLY

When set to **ON**, this parameter prevents the sequencer from playing notes, but continues transmission of sequence mod values. It effectively turns your sequencer into a 1-64 step modulation source. The default is **OFF**.

MODWHL CTRL

When set to **ON**, the Mod Wheel provides real-time scaling of sequence modulation values, where the maximum value is set by the **SEQ MOD AMT** parameter. The default is **OFF**.

***NOTE:** The modulation value for a step is set using the Mod Wheel, either while Recording a sequence or while a step is selected for editing in Step Edit. The mod value is bipolar, so setting the Mod Wheel to its lowest position sends the maximum “negative” modulation value, while the highest position sends the maximum “positive” modulation value. Setting the Mod Wheel at its center position sends “no modulation”.*

***EXAMPLE:** To use the per-step modulation to set a switched parameter from (normally) **OFF** to (modulated) **ON**, move the Mod Wheel all the way up when setting the **SEQ MOD** value for the sequence step. To set a switched parameter from (normally) **ON** to (modulated) **OFF**, move the Mod Wheel all the way down when recording to set a negative mod value for the sequence step.*

RATCHET CT

When Ratchet is selected for a specific step in a sequence, the Ratchet Count causes that step to repeat multiple times within a single step-duration. You can set the ratchet multiple from 1x (no repeats) to 8x. The default is 2x.

FILTER EG (PRESET EDIT 1.3)

Highlight **FILTER EG >>** and press the **CURSOR** button to enter the **FILTER EG** sub menu.

GATE SRC

This is used to select which gate sources trigger the filter envelope. With **NOTES** selected, only key presses and arpeggiations will trigger the filter envelope. The **KB GATE** jack on the left side of the Subsequent 37 will not affect the filter envelope. With **EXT** selected, only trigger voltages received at the **KB GATE** jack will trigger the filter envelope. Neither key presses nor arpeggiations will affect the filter envelope. With **BOTH** selected, the keyboard, arpeggiations and the **KB GATE** will trigger the filter envelope.

EXP. ATTACK

This parameter determines if the filter envelope’s attack curve is linear (**OFF**) or exponential (**ON**). The default is **OFF**. An exponential attack will have a steeper slope on its way to the maximum value. Each slope has its own sonic advantages, which vary depending on whether you’re using very fast or very slow attack times.

CLOCK DIV

This specifies the filter envelope’s repeating relationship to the internal or MIDI clock when the envelope **SYNC** button is illuminated. The first value is 4, which means that the filter envelope is triggered every 4 whole notes (384 MIDI clocks). The highest value is 1/64T, which means that the filter envelope is re-triggered every 1/64th-note triplet (1 MIDI clock). Please refer to the chart on page 52 for a list of available clock divisions.

AMPLIFIER EG (PRESET EDIT MENU 1.4)

Highlight **AMPLIFIER EG >>** and press the **CURSOR** button to enter the **AMPLIFIER EG** sub menu.

GATE SRC

This is used to select which gate sources trigger the amplifier envelope. With **NOTES** selected, only key presses and arpeggiations will trigger the amplifier envelope. The **KB GATE** jack on the left side of the Subsequent 37 will not affect the amplifier envelope. With **EXT** selected, only trigger voltages received at the **KB GATE** jack will trigger the amplifier envelope. Neither key presses nor arpeggiations will affect the amplifier envelope. With **BOTH** selected, the keyboard, arpeggiations and the **KB GATE** will trigger the amplifier envelope.

EXP. ATTACK

This parameter determines if the amplifier envelope's attack curve is linear (**OFF**) or exponential (**ON**). Default is **OFF**. An exponential attack will have a steeper slope on its way to the maximum value. Each slope has its own sonic advantages, which vary depending on whether you're using very fast or very slow attack times.

CLOCK DIV

This specifies the amplifier envelope's repeating relationship to the internal or MIDI clock when the envelope's button is illuminated. The first value is 4, which means that the amplifier envelope is triggered every 4 whole notes (384 MIDI clocks). The highest value is 1/64T, which means that the amplifier envelope is re-triggered every 1/64th-note triplet (1 MIDI clock). Please refer to the chart on page 52 for a list of available clock divisions.

KB TRANSPOSE (PRESET EDIT MENU 1.5)

This parameter allows you to transpose the Subsequent 37's keyboard from -12 half steps to +12 half steps. The default is **OFF**. To transpose the keyboard from the front panel, hold both the **KB OCTAVE UP** and **DOWN** buttons at the same time, and play any single note in the lower two octaves of keys. Pressing Middle C will set the transposition to +0 (default). Keys to the left of Middle C will transpose downward, and keys above Middle C will transpose upwards. This is stored as part of the preset.

KB PRIORITY (PRESET EDIT MENU 2.1)

Because the Subsequent 37 is monophonic (unless in **DUO MODE**), it will play only one note at a time. By default, when you press two keys at the same time, it plays the most recent key you pressed, regardless of its position. This is called last-note priority. You can change that behavior, however, so that it will play either the lowest or the highest note when you press more than one key. The choices are **LOW** (low-note priority), **HIGH** (high-note priority), or **LAST** (last-note priority). When the **DUO MODE** button is lit, oscillator two will follow the low key, high key, or no keys, as indicated by the **LO** and **HI** LEDs in the oscillator section. There is a global override of per-preset keyboard note priority in the **GLOBAL MENU**. If **LOW**, **HIGH**, or **LAST** is chosen there, all **KB PRIORITY** settings will be ignored.

BEND UP (PRESET EDIT MENU 2.2)

This specifies the maximum upward pitch bend amount of the **PITCH** wheel in half-step (100 cent) intervals. The default is +2 (one whole step, 200 cents). The range is from +0 to +24 (two octaves).

BEND DOWN (PRESET EDIT MENU 2.3)

This specifies the maximum downward pitch bend amount of the **PITCH** wheel in half-step (100 cent) intervals. The default is -2 (one whole step down, -200 cents). The range is from -0 to -24 (two octaves).

BEND DEST (PRESET EDIT MENU 2.4)

This selects which of the two oscillators will respond to the **PITCH** wheel. **NONE** will send no pitch bend control to either oscillator. This allows you to use the **PITCH** wheel for other **MOD** destinations. **OSC 1** sends pitch bend control only to oscillator 1. **OSC 2** sends pitch bend control only to oscillator 2. And **BOTH** sends pitch bend control to both oscillators.

PRESET VOL (PRESET EDIT MENU 2.5)

This allows you to scale the total volume of each preset individually for level matching loud and soft patches. The default is **100%** with a value range of **OFF (0%)** to **100%**.

GLOBAL MENU

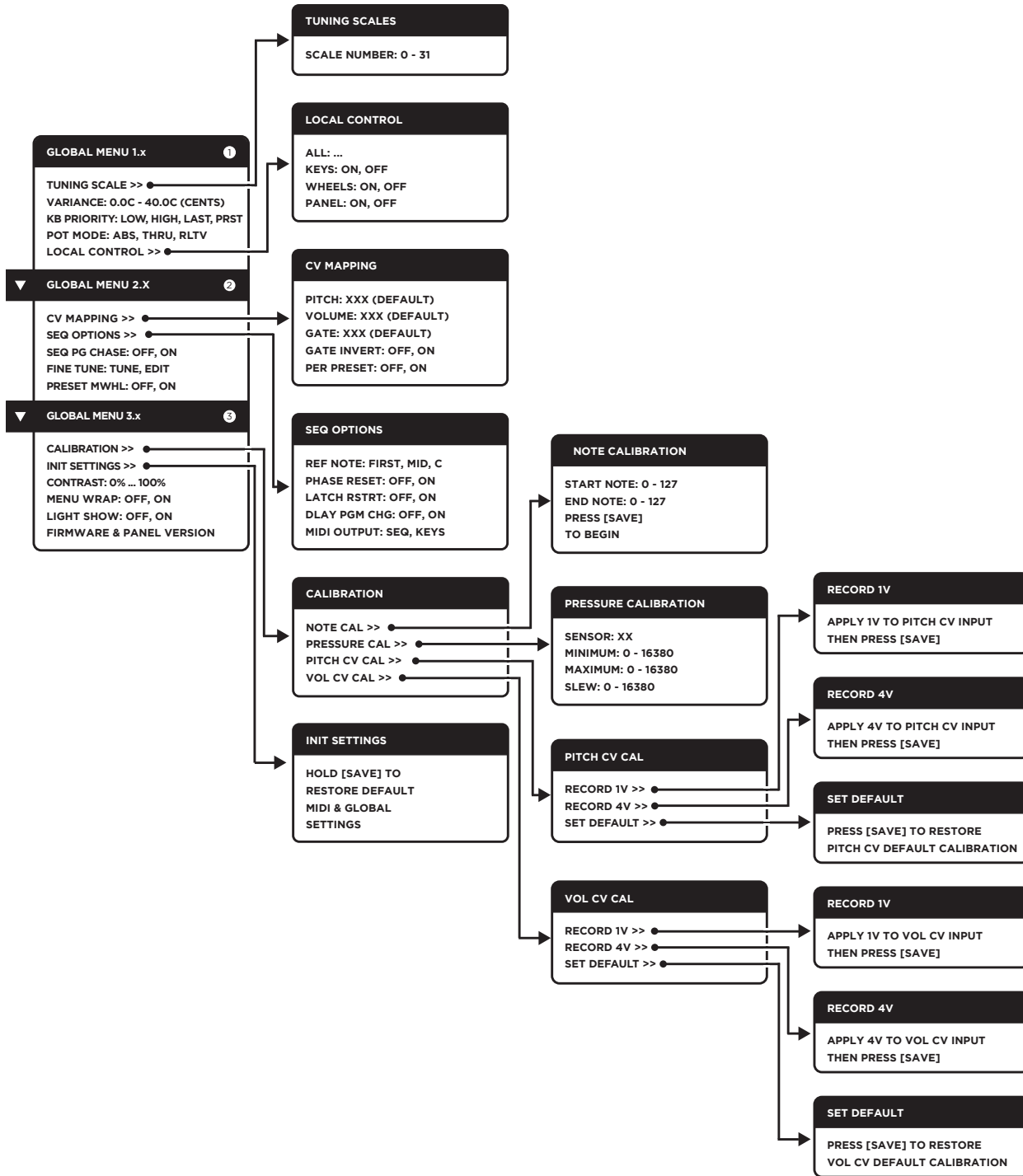

Pressing the **GLOBAL** button takes you to the **GLOBAL MENU**, which contains parameters that affect all presets. When the **GLOBAL** button is illuminated the top right of the LED display will indicate which page you are on, followed by a decimal point, and then which parameter line you have selected. Use the ▼ ▲ buttons to choose a parameter for editing, and the **FINE TUNE** knob to scroll through a selected parameter's available options.

NOTE: You can also use the **CURSOR** button to select a parameter and the ▼ ▲ buttons to step through the selected parameter's available options. To exit a parameter, simply press **CURSOR** again.

If more than one page of parameters exists, continuing to press the ▼ button will take you through the additional parameters and pages. If the **MENU WRAP** parameter (**GLOBAL MENU**) is **OFF**, the ▼ button will stop working at the last parameter of the last page.

SUB MENU PARAMETERS

Some parameter types have multiple sub parameters, which are indicated by ">>". If you have one of these menu titles highlighted, you can jump to the sub menu by pressing the **CURSOR** button. To exit a sub menu highlight the "**(BACK)<<**" parameter and press the **CURSOR** button. This will take you back to the previous menu.

GLOBAL MENU PARAMETERS

TUNING SCALES (GLOBAL MENU 1.1)

The Subsequent 37 can store up to 31 custom 1-octave tuning scales in its memory. Scale number 0 (default) is a 12 tone equal tempered tuning. You can create and load custom scales using the Phatty Tuner application for Mac or Windows, available as a free download from Moogmusic.com.

Highlight **TUNING SCALE >>** and press the **CURSOR** button to enter the **TUNING SCALES** sub menu. Now you can use the **FINE TUNE** knob to select a scale number. You can also change tuning scale via MIDI, using RPN [Registered Parameter Number*] MSB 0, LSB 3. After setting RPN #3, send Data Entry (CC #39) value 0 -31 to select the corresponding numbered scale, or send CC #96 [Increment] or CC #97 [Decrement] to select the next/previous scale. RPN MSB is set using CC #101, RPN LSB is set using CC # 100.

The Subsequent 37 also supports the MIDI tuning standards for Single-Note Tuning Change and Bulk Tuning Dump (full 128-note tunings), in addition to the Scale/Octave format. The Subsequent 37 holds a single 128-note tuning table in its active memory, which is not saved on power-down.

Additional documentation about **MIDI SINGLE NOTE TUNING CHANGE** can be found here:
<http://www.midi.org/techspecs/midituning.php>

You can also use computer software called Scala to send thousands of pre-made full tuning tables to the Subsequent 37: <http://www.huygens-fokker.org/scala/>

VARIANCE (GLOBAL MENU 1.2)

This parameter allows you to add a small random tuning offset to each note. The offset is updated at each note-on event. Oscillators 1 and 2 are offset symmetrically; if Oscillator 1 is offset 3.1 cents sharp, Oscillator 2 will be 3.1 cents flat. The **VARIANCE** parameter sets the maximum amount of detuning, using increments of 0.1 cents.

KB PRIORITY (GLOBAL MENU 1.3)

Because the Subsequent 37 is monophonic (unless in **DUO MODE**), it will play only one note at a time. By default, it plays a note in response to the most recent key you pressed, regardless of its position. This is called last-note priority. You can change this behavior so that it will play either the lowest or the highest note when you press more than one key. The choices are **LOW** (low-note priority), **HIGH** (high-note priority), **LAST** (last-note priority) and **PRST** (as dictated by each preset's specification in the **PRESET EDIT** menu). When the **DUO MODE** button is illuminated, oscillator two will follow the low key, high key, or no keys, as indicated by the **LO** and **HI** LEDs in the oscillator section.

NOTE: Any selection other than **PRST** will override **ALL** per-preset **KB PRIORITY** settings.

GLOBAL MENU PARAMETERS (CONTINUED)

POT MODE (GLOBAL MENU 1.4)

When changing presets, the physical positions of the panel knobs will not match the values saved in a preset. **POT MODE** allows you to specify how a knob responds when you make changes to its position.

ABS: In absolute mode (default) the value of a parameter jumps to the knob's current position as soon as you begin turning it.

THRU: In pass through mode turning a knob has no effect until it reaches its preset value and then takes effect.

RLTV: In relative mode turning a knob up or down slightly causes a minor change in value, while turning it further causes an increasingly greater change in value. This allows the value to "catch up" with the knob's position and prevents any sudden jumps in sound.

NOTE: *Relative and pass through modes are recommended for live performance, while absolute mode is recommended for creating new sounds.*

LOCAL CONTROL (GLOBAL MENU 1.5)

Highlight **LOCAL CONTROL >>** and press the **CURSOR** button to enter the **LOCAL CONTROL** sub menu. Sometimes it's useful to disable the keyboard and/or other physical controllers on the Subsequent 37 when using it as a MIDI controller or when recording tracks into a DAW.

ALL

When **ON**, all of the Subsequent 37 controls, features, and functions send MIDI data to the Subsequent 37 as well as the specified MIDI OUTs. When **OFF**, no physical controls, features, or functions have any impact on the Subsequent 37, but all MIDI data is still transmitted to the specified MIDI outputs.

KEYS

When **ON**, the Subsequent 37 keyboard sends MIDI data both to the internal sound engine as well as the specified MIDI OUTs. When **OFF**, the keyboard data is not transmitted internally meaning it has no effect on the Subsequent 37, but keyboard MIDI data is still transmitted to the specified MIDI outputs.

WHEELS

When **ON**, the Subsequent 37 **PITCH** bend and **MODULATION** wheels send MIDI data both to the internal sound engine as well as the specified MIDI OUTs. When **OFF**, the pitch bend and modulation data is not transmitted internally meaning it has no effect on the Subsequent 37, but their MIDI data is still transmitted to the specified MIDI outputs.

PANEL

When **ON**, all of the Subsequent 37 knobs and buttons send MIDI data to the Subsequent 37 as well as the specified MIDI OUTs. When **OFF**, no physical knobs or panel buttons have any impact on the Subsequent 37, but their MIDI data is still transmitted to the specified MIDI outputs.

CV MAPPING (GLOBAL MENU 2.1)

The **CV MAPPING** submenu allows you to map the external **PITCH CV**, **VOLUME CV** and **KB GATE** inputs to various parameters and functions. The CV mapping of **PITCH CV** and **VOLUME CV** to a desired parameter allows you to connect a continuous controller pedal (with a 1/4" TRS plug) to one of the CV inputs and then directly control the mapped parameter. The **KB GATE** input is similar but uses a 1/4" TS footswitch and typically controls switch-based parameters.

PITCH

Maps an external **PITCH CV** controller to virtually any Subsequent 37 sound parameter, as well as three special functions, **SQMODAMT**, **RTCHT CT**, and **ST1 RESET**.

SQMODAMT: Sequence Mod Amount scales the **SEQ MOD** values stored in each step of the Sequence.

GLOBAL MENU PARAMETERS (CONTINUED)

PITCH (CONTINUED)

RTCHT CT

Ratchet Count allows you to change, in real time, the Ratchet Count from 1x - 8x. All steps that have Ratchet On will respond to these changes.

ST1 RESET

Step 1 Reset causes the Arp or Sequencer to restart at step 1 any time a voltage trigger (voltage rising from below 2.5 volts to greater than 2.5 volts) is detected at the CV input. Using both the **ST1 RESET** and **STEP ADV** mappings, you can sync the Subsequent 37 sequencer to external trigger control in a number of creative ways.

VOLUME

Maps the external **VOL CV** controller to virtually any Subsequent 37 sound parameters, including **SQMODAMT**, **RTCHT CT**, and **ST1 RESET**.

GATE

The **KB GATE** external input can be mapped to any on/off type parameter, as well as two special functions, **STEP ADV** and **SUST PED**.

STEP ADV

Uses a voltage trigger at the **KB GATE** input to advance the arpeggiator or sequencer step. While the **STEP ADV** mapping is active, the internal clock and MIDI clock sync are overridden for the Arpeggiator and Sequencer (although the LFOs and Envelopes continue to sync to Internal or MIDI clock according to the **SYNC** setting in the Arpeggiator section).

SUST PED

Sets the **KB GATE** input to work as a simple Sustain pedal, without triggering the Subsequent 37 gate/envelopes directly.

GATE INVERT

A setting of **ON** reverses the effect of the **KB GATE** input. This allows the Subsequent 37 to accommodate normally-open or normally-closed footswitches. The default is **OFF**.

PER PRESET

When set to **ON**, this function loads CV Mapping settings for each preset. If **PER PRESET** is **OFF** (default), then the Global **CV MAPPING** settings will persist when changing presets.

SEQUENCER OPTIONS (GLOBAL MENU 2.2)

Highlight **SEQ OPTIONS >>** and press the **CURSOR** button to enter the **SEQUENCER OPTIONS** sub menu.

REF NOTE

When playing a step sequence in the **ARPEGGIATOR** section, you can change the key of that sequence by playing different notes. When **REF NOTE** is set to **FIRST** (default), the note you press to start the sequence dictates the actual first note of that sequence. When you choose the **MID C** parameter, pressing Middle C on the keyboard will start the sequence on the same pitch it was recorded. Playing any other key above or below Middle C will result in a transposition (up or down) equal to that key's distance from Middle C.

GLOBAL MENU PARAMETERS (CONTINUED)

SEQUENCER OPTIONS (CONTINUED)

PHASE RESET

When set to **ON**, the sequencer timing (the downbeat) is reset the moment a new note is played. If **PHASE RESET** is **OFF** (default), then the timing of the sequencer is set by the arpeggiator or in response to a MIDI Start message, but the downbeat is not reset when a new note is played.

***NOTE:** When **PHASE RESET** is **OFF** and you play a new note before the downbeat, the arp or sequence will not start until the next beat.*

LATCH RSTRT

Latch Restart determines the sequencer behavior when the **LATCH** button is illuminated. If **LATCH RSTRT** is **ON**, then each new note press (with no notes held) will restart the sequence from its first step. If **LATCH RSTRT** is **OFF** (default), then new note presses will not restart the sequence; it will transpose as appropriate without resetting to the first step. In either case, if a new note is played while a previous note is still held, the sequence will transpose without restarting.

DLAY PGM CHG

If Delay Program Change is **ON**, then a preset change made while a sequence is playing will be delayed until the end of the sequence. At the downbeat of the first step, it will switch to the newly selected preset. If the new preset also contains an active sequence, it should also begin playing seamlessly at this time. If **DLAY PGM CHG** is set to **OFF** (default) the preset will change instantly.

MIDI OUT

This determines if the notes coming from the Subsequent 37's MIDI Output are the actual keys being played (**KEYS**) or the notes being generated by the arpeggiator's sequence (**SEQ**). **SEQ** is the default setting.

SEQ PG CHASE (GLOBAL MENU 2.3)

Sequence Page Chase controls the display of pages 1 through 4 of step data while in Step Edit mode. If **SEQ PG CHASE** is **ON** (default), then the step display (**PRESET BUTTONS 1-16**) will automatically "chase" during playback, always showing the page of steps that is currently playing. When you want to edit a multi-page sequence while it is playing, it can be helpful to turn **SEQ PG CHASE** to **OFF**, in which case you can manually specify which page is displayed, even while the sequence is playing steps on other sequence pages.

FINE TUNE (GLOBAL MENU 2.4)

This parameter determines the function of the **FINE TUNE** knob while you are navigating through the edit menus and naming presets. When **TUNE** is selected the **FINE TUNE** knob always adjusts the fine-tuning of the Subsequent 37. When **EDIT** (default) is selected the **FINE TUNE** knob can be used to adjust a highlighted parameter's value without having to first press the **CURSOR** button. When you exit the edit menus the **FINE TUNE** knob resumes its primary function.

PRESET MWHL (GLOBAL MENU 2.5)

Determines whether a preset's initial modulation depth is controlled by the mod wheel's current position or the position that was current when the patch was saved. The choices are **ON** (default) which loads the **MOD WHEEL** position when the preset was last saved, and **OFF** which globally follows the current **MOD WHEEL** position.

CALIBRATION (GLOBAL MENU 3.1)

When this is highlighted, pressing the **CURSOR** button takes you into the **CALIBRATION** sub menu, which allows you to run calibration routines for the oscillators, aftertouch, and Pitch CV Input.

GLOBAL MENU PARAMETERS (CONTINUED)

NOTE CAL

When **NOTE CAL** is highlighted, pressing the **CURSOR** button takes you into the **NOTE CALIBRATION** menu. Note calibration allows you to run a full-range calibration procedure, which ensures the oscillators remain in tune for every playable note. During note calibration, the Subsequent 37 “listens” to each note the oscillators produce and then adjusts them to the expected pitch. The control voltage required to produce that pitch is recorded and saved in the Subsequent 37’s internal memory.

***NOTE:** Note calibration is not the same as the **FINE TUNE** knob on the front panel. **FINE TUNE** adjusts the overall reference pitch for the synthesizer, allowing you to quickly bring the synthesizer in tune with other instruments. The two operations do not depend on each other.*

Because the oscillators in the Subsequent 37 are extremely stable, note calibration should rarely need to be performed.

To run note calibration, choose the range of notes you wish to calibrate, and press **SAVE**. The standard note range is the full range of notes the Subsequent 37’s oscillators can produce (MIDI notes 15 through 116). Because calibration is a slow process, if you only need to calibrate a few notes, you can save time by choosing a smaller note range. Normally, however, you should calibrate the full range.

START NOTE

This chooses the lowest note number to be calibrated. It is best left at 15 unless you have a very specific reason for doing otherwise.

END NOTE

This chooses the highest note number to be calibrated. It is best left at 116 unless you have a very specific reason for doing otherwise.

PRESSURE CAL

When this is highlighted, pressing the **CURSOR** button takes you into the **PRESSURE CALIBRATION** sub menu which allows you to set values for the precise tracking of aftertouch.

SENSOR

This is a real-time readout of the aftertouch sensor’s current value. You can press any or no keys to observe the typical minimum value (no pressure) and maximum value (a lot of pressure). Some keys may have higher values than others.

MINIMUM

To achieve the full range of response to aftertouch set this value to the lowest **SENSOR** value while not touching any keys. (If you want aftertouch to work only when you press the keys significantly harder, set this value higher than the lowest **SENSOR** value.) Press **CURSOR** to highlight the numeric value for **MINIMUM**. While this value is highlighted, press the **SAVE** button to capture the current **SENSOR** value as the **MINIMUM** value.

MAXIMUM

To achieve the full range of response to aftertouch you will want to set this value to the highest **SENSOR** value while applying full pressure to multiple keys simultaneously. Press **CURSOR** to highlight the numeric value for **MAXIMUM**. While this value is highlighted, press the **SAVE** button to capture the current **SENSOR** value as the **MAXIMUM** value.

GLOBAL MENU PARAMETERS (CONTINUED)

PRESSURE CAL (CONTINUED)

SLEW

This parameter adds a glide time between aftertouch amounts. Increasing the number will give you a smoother aftertouch response. Lower values will give you a more precise response. Experiment to find the setting that's right for you. The default value is 200.

PITCH CV CAL

When this is highlighted, pressing the **CURSOR** button takes you into the **PITCH CV CALIBRATION** sub menu which allows you to run a calibration routine for incoming pitch CV's.

RECORD 1V

Apply 1 Volt DC to the **PITCH CV** Input jack and then press **SAVE**.

RECORD 4V

Apply 4 Volt DC to the **PITCH CV** Input jack and then press **SAVE**.

USE DEFAULT

If you are not happy with your own calibration. Press **SAVE** and the default 1V and 4V calibration is restored.

VOL CV CAL

When this is highlighted, pressing the **CURSOR** button takes you into the **VOL CV CALIBRATION SUB MENU** which allows you to run a calibration routine for incoming volume CV's.

RECORD 1V

Apply 1 Volt DC to the **VOL CV** Input jack and then press **SAVE**.

RECORD 4V

Apply 4 Volt DC to the **VOL CV** Input jack and then press **SAVE**.

USE DEFAULT

If you are not happy with your own calibration. Press **SAVE** and the default 1V and 4V calibration is restored.

INIT SETTINGS (GLOBAL MENU 3.2)

When this is highlighted you can press **CURSOR** to enter a page that allows you to reset the system settings (everything in the **MIDI MENU** and **GLOBAL MENU**) to their default values. To initialize, hold the **SAVE** button until it counts down from 5 to 1. If you let go before it passes 1 it will abort the initialization. If you hold **SAVE** for the full 5 count the display will confirm that you have initialized the system settings. **NOTE: INIT SETTINGS will NOT erase the factory or user presets, only the MIDI and GLOBAL settings.**

CONTRAST (GLOBAL MENU 3.3)

This parameter changes the display screen's contrast level. At lower settings the text will appear fainter. At higher settings the text will appear darker. The appropriate setting is dictated by your viewing angle, the ambient lighting in the room, and even the temperature of the room. The default is **64%**.

MENU WRAP (GLOBAL MENU 3.4)

When set to **ON** (default) the very last parameter in any menu will then lead back to the very first menu parameter. When **MENU WRAP** is set to **OFF**, then pressing the **▼** button will have no effect once you've reached the very last parameter in a menu.

LIGHT SHOW (GLOBAL MENU 3.5)

Amuse your friends and confound your enemies. When set to **ON**, the front panel LEDs flash in a 1960s "futuristic" manner. While perfect for breaks, between sets, and television appearances, the default is **OFF** since you can't see any of your button choices when it is animating (although everything is fully functional when **LIGHT SHOW** is **ON**). Use the **ARPEGGIATOR RATE** knob to change the speed of the light show.

FIRMWARE AND PANEL VERSIONS

The bottom line of this display page shows the current firmware versions installed on your Subsequent 37.

CONTROLLERS MENU

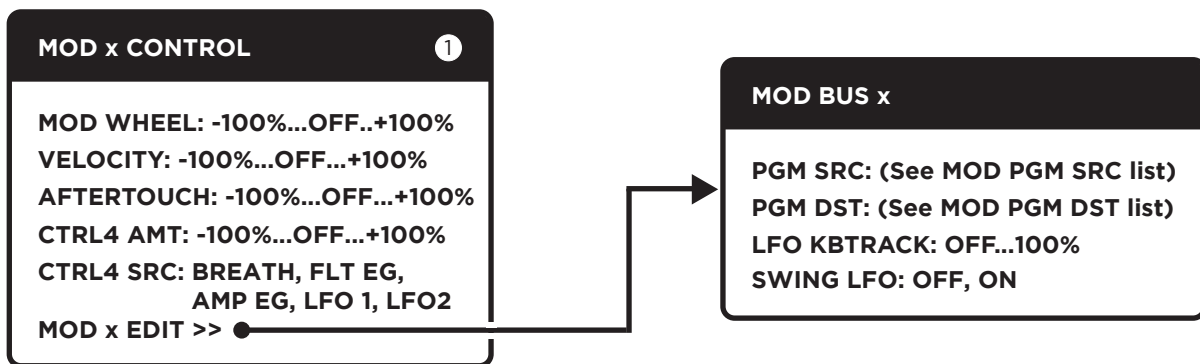

Pressing this button takes you to the **MOD 1** or **MOD 2 CONTROL MENU** on the LED display screen. Here you can determine the amount of effect that the **MODULATION** wheel, **VELOCITY**, **AFTERTOUCH**, and an assignable **CONTROLLER 4**, have on the modulation destinations. Use the ▼ ▲ buttons to choose a parameter for editing, and the **FINE TUNE** knob to scroll through a selected parameter's available options. **NOTE:** You can also use the **CURSOR** button to select a parameter and the ▼ ▲ buttons to step through the selected parameter's available options. To exit a parameter, simply press **CURSOR** again.

CONTROL MENU PARAMETERS

MOD WHEEL

This parameter sets the modulation depth caused when the **MODULATION** wheel is raised to its maximum position. The values range from **-100%** to **+100%**.

VELOCITY

This parameter sets the modulation depth caused when the keyboard velocity is played at its fastest speed. The values range from **-100%** to **+100%**.

AFTERTOUCH

This parameter sets the modulation depth caused when the keyboard aftertouch is pressed fully. The values range from **-100%** to **+100%**.

CTRL4 AMT

This parameter sets the modulation depth caused when a designated external MIDI CC (currently fixed as CC#2) or other **CTRL4 SRC** is sent to the Subsequent 37. The values range from **-100%** to **+100%**.

CTRL4 SRC

This parameter allows you to choose the source of the fourth modulation depth controller. It had been previously fixed to **CC#2 BREATH**, but can now also be assigned to **FLT EG** (Filter EG), **AMP EG**, **LFO 1**, or **LFO 2**. If you choose **FLT EG** as the source, you can set the **EG's DELAY** parameter to receive a delayed LFO onset, for example.

MOD (1 OR 2) EDIT

Highlight **MOD (1 OR 2) EDIT >>** and press the **CURSOR** button to enter the **MOD EDIT** sub menu.

PGM SRC

This parameter allows you to change the **MOD's** sixth modulation source from **FILTER EG** to:

AMP EG: Amplitude Envelope Generator
SINE LFO: Extra Sine Wave LFO
OSC1 PCH: Oscillator 1's Pitch
SEQ NOTE: Current Note of the Sequencer
SEQ MOD: Mod Wheel Amount Stored In Sequence Step
VELOCITY: Latest Note On velocity

CONST ON: Constant On
NOISE LFO: Extra Noise LFO
OSC2 PCH: Oscillator 2's Pitch
SEQ VEL: Current Velocity of the Sequencer
PRESSURE: Current Aftertouch Amount
KB TRACK: The current Key Tracking value (bi-polar, centered on MIDI Note 48, Middle C)

CONTROLLERS MENU (CONTINUED)

PGM DST

This parameter allows you to specify the MOD's sixth modulation destination from the default of **EG TIME** to:

- FILT RES:** Filter Resonance Amount
- FILT SLP:** Filter poles slope (-6, -12, -18, -24)
- F KB AMT:** Filter Keyboard Tracking Amount
- SUB LEV:** Sub Oscillator Level
- EXFB LEV:** External Input /Feedback Level
- SUB ON:** Sub Oscillator ON/OFF Control
- NOISE ON:** Noise Generator ON/OFF Control
- ARP RATE:** Arpeggiator Rate
- ARP RNGE:** Arpeggiator Range
- ARP BFMD:** Arpeggiator Back/Forth Ends
- ARP GLEN:** Arpeggiator Gate Length
- GLD TIME:** Glide Time
- GLD TYPE:** Glide Type (LCR, LCT, or EXP)
- GLD LGTO:** Glide Legato
- LFO1CKDV:** LFO 1 Clock Divisions (When Synced)
- LFO1SYNC:** LFO 1 Arp Sync ON/OFF
- LFO1KBTRK:** LFO 1 Keyboard Tracking Amount
- MOD1FAMT:** Mod Bus 1 Filter Amount
- MOD1PDST:** Mod Bus 1 Programmable Destination
- LFO2RNGE:** LFO 2 Range (LOW, MED, HIGH)
- LFO2KRST:** LFO 2 Keyboard Reset ON/OFF
- MOD2PAMT:** Mod Bus 2 Pitch Amount
- MOD2PGMA:** Mod Bus 2 Programmable Destination Amount
- OSC1 OCT:** Oscillator 1 Octave (16', 8', 4', 2')
- OSCKBRST:** Oscillators Keyboard Reset
- OSC2KCTL:** Oscillator 2 Keyboard Control for Duo Mode (DRONE, LOW NOTE, HIGH NOTE)
- OSC2BEAT:** Oscillator 2 Beat Frequency Offset
- F EG DCY:** Filter Envelope Generator Decay
- F EG REL:** Filter Envelope Generator Release
- F EG HLD:** Filter Envelope Generator Hold
- F EG KTRK:** Filter Envelope Generator Keyboard Tracking Amount
- F EG RST:** Filter Envelope Generator Reset ON/OFF
- F EG LOOP:** Filter Envelope Generator Loop ON/OFF
- A EG ATK:** Amplitude Envelope Generator Attack
- A EG SUS:** Amplitude Envelope Generator Sustain
- A EG HLD:** Amplitude Envelope Generator Hold
- A EG KTRK:** Amplitude Envelope Generator Keyboard Tracking Amount
- A EG RST:** Amplitude Envelope Generator Reset ON/OFF
- A EG LOOP:** Amplitude Envelope Generator Loop ON/OFF
- OUT VOL:** Master Volume Level
- BEND DOWN:** Pitch Bend Down Max Amount
- LFO1SWNG:** LFO 1 Swing Amount
- SQMODAMT:** Seq Mod Amount To Destination
- FILT DRV:** Filter Multidrive Amount
- F EG AMT:** Filter Envelope Generator Amount
- OSC1 LEV:** Oscillator 1 Level
- OSC2 LEV:** Oscillator 2 Level
- OSC1 ON:** Oscillator 1 ON/OFF Control
- OSC2 ON:** Oscillator 2 ON/OFF Control
- EXFB ON:** External Input/Feedback ON/OFF
- ARP CLKDV:** Arpeggiator Clock Divisions
- ARP BKFD:** Arpeggiator Backwards/Forwards
- ARP INV:** Arpeggiator Invert
- ARP RUN:** Arpeggiator Run/Stop
- GLD OSC:** Glide Oscillator Assignment
- GLD GATE:** Glide Gated Control ON/OFF
- GLD ON:** Glide ON/OFF
- LFO1RNGE:** LFO 1 Range (LOW, MED, HIGH)
- LFO1KBRS:** LFO 1 Keyboard Reset ON/OFF
- MOD1PAMT:** Mod Bus 1 Pitch Amount
- MOD1PGMA:** Mod Bus 1 Programmable Destination Amount
- LFO2CKDV:** LFO 2 Clock Divisions (When Synced)
- LFO2SYNC:** LFO 2 Arp Sync ON/OFF
- LFO2KTRK:** LFO 2 Keyboard Tracking Amount
- MOD2FAMT:** Mod Bus 2 Filter Amount
- MOD2PDST:** Mod Bus 2 Programmable Destination
- OSC2 SYNC:** Oscillator 2 Hard Sync ON/OFF
- OSC2 OCT:** Oscillator 2 Octave (16', 8', 4', 2')
- OSC 2 DUO:** Oscillator 2 Duophonic mode ON/OFF
- OSC2FREQ:** Oscillator 2 Frequency Offset
- F EG ATK:** Filter Envelope Generator Attack
- F EG SUS:** Filter Envelope Generator Sustain
- F EG DLY:** Filter Envelope Generator Delay
- F EG VAMT:** Filter Envelope Generator Velocity
- F EG MTRG:** Filter Envelope Generator Multi-trigger ON/OFF
- F EG SYNC:** Filter Envelope Generator Sync to Arpeggiator Clock
- F EG LTCH:** Filter Envelope Generator Latch ON/OFF
- A EG DCY:** Amplitude Envelope Generator Decay
- A EG REL:** Amplitude Envelope Generator Release
- A EG VAMT:** Amplitude Envelope Generator Velocity
- A EG MTRG:** Amplitude Envelope Generator Multi-trigger ON/OFF
- A EG SYNC:** Amplitude Envelope Generator Sync to Arpeggiator Clock
- A EG LTCH:** Amplitude Envelope Generator Latch ON (always ON) /OFF
- BEND UP:** Pitch Bend Up Max Amount
- ARP SWING:** Arpeggiator Swing Amount
- LFO2SWNG:** LFO 2 Swing Amount
- RTCHT CT:** Ratchet Count (1 - 8)

CONTROLLERS MENU CONT.

LFO KBTRACK

This parameter allows you to change the **LFO RATE** based on the key number. The values range from **0%** to **200%**. When this value is increased the LFO will speed up as you go higher up the keyboard.

LFO (1 OR 2) SWING

This parameter, when **ON** (default) causes the LFO to swing at the amount set in the **PRESET EDIT / APREGGIATOR** sub menu.

MIDI OPERATIONS

MIDI CHANNEL

By default, the Subsequent 37 is set to receive and send MIDI on Channel 1, but it can be configured to send and receive on MIDI Channel (1 - 16).

MIDI CONTROL CHANGE (CC) MESSAGES

The tables on the following pages list all MIDI CC messages for the Subsequent 37.

MIDI CC VALUES FOR THE LFO 1 CLOCK DIVIDER (CC #3), LFO 2 CLOCK DIVIDER (CC #8)

TIME VALUE	DIVISION	VALUE
4 WHOLE NOTES	4 WHOLE	0-6
3 WHOLE NOTES	3 WHOLE	7-12
2 WHOLE NOTES	2 WHOLE	13-18
WHOLE NOTE + HALF NOTE	WH + 1/2	19-24
WHOLE NOTE	WH	25-40
DOTTED 1/2 NOTE	1/2 DOT	31-36
WHOLE NOTE TRIPLET	WH T	37-42
1/2 NOTE	1/2	43-48
DOTTED 1/4 NOTE TRIPLET	1/4 DOT	49-54
1/2 NOTE TRIPLET	1/2 T	55-60
1/4 NOTE	1/4	61-67
DOTTED 1/8 NOTE	1/8 DOT	68-73
1/4 NOTE TRIPLET	1/4 T	74-79
1/8 NOTE	1/8	80-85
DOTTED 1/16 NOTE	1/16 DOT	86-91
1/8 NOTE TRIPLET	1/8 T	92-97
1/16 NOTE	1/16	98-103
1/16 NOTE TRIPLET	1/16 T	104-109
1/32 NOTE	1/32	110-115
1/32 NOTE TRIPLET	1/32 T	116-121
1/64 NOTE TRIPLET	1/64 T	122-127

CONTROL/PARAMETER	MIDI CC #	CC VALUE RANGE
BANK SELECT	0	ALWAYS TRANSMITS 0, SHOULD ALWAYS SEND 0 WHEN SENDING THIS CC
MOD WHEEL	1 [MSB], 33 [LSB]	0-127 [MSB], 0-16383[MSB,LSB]
<RESERVED - MIDI BREATH CTRL>	2 [MSB], 34 [LSB]	0-127 [MSB], 0-16383[MSB,LSB]
LFO 1 RATE	3 [MSB], 35 [LSB]	0-127 [MSB], 0-16383[MSB,LSB]
MOD 1 PITCH AMT	4 [MSB], 36 [LSB]	0-127 [MSB], 0-16383[MSB,LSB]
GLIDE TIME	5 [MSB], 37 [LSB]	0-127 [MSB], 0-16383[MSB,LSB]
<RESERVED - DATA ENTRY>	6 [MSB], 38 [LSB]	
MASTER VOLUME	7 [MSB], 39 [LSB]	0-127 [MSB], 0-16383[MSB,LSB]
LFO 2 RATE	8 [MSB], 40 [LSB]	0-127 [MSB], 0-16383[MSB,LSB]
OSC 1 WAVE	9 [MSB], 41 [LSB]	0-127 [MSB], 0-16383[MSB,LSB]
<RESERVED - MIDI PAN >	10 [MSB], 42 [LSB]	
MOD 1 FILTER AMT	11 [MSB], 43 [LSB]	0-127 [MSB], 0-16383[MSB,LSB]
OSC 2 FREQ	12 [MSB], 44 [LSB]	0-127 [MSB], 0-16383[MSB,LSB]
OSC 2 BEAT FREQ	13 [MSB], 45 [LSB]	0-127 [MSB], 0-16383[MSB,LSB]
OSC 2 WAVE	14 [MSB], 46 [LSB]	0-127 [MSB], 0-16383[MSB,LSB]
MOD 2 PITCH AMT	15 [MSB], 47 [LSB]	0-127 [MSB], 0-16383[MSB,LSB]
MOD 2 FILTER AMT	16 [MSB], 48 [LSB]	0-127 [MSB], 0-16383[MSB,LSB]
MOD 2 PGM DEST AMT	17 [MSB], 49 [LSB]	0-127 [MSB], 0-16383[MSB,LSB]
FILTER MULTIDRIVE	18 [MSB], 50 [LSB]	0-127 [MSB], 0-16383[MSB,LSB]
FILTER CUTOFF	19 [MSB], 51 [LSB]	0-127 [MSB], 0-16383[MSB,LSB]
MOD 1 PGM DEST AMT	20 [MSB], 52 [LSB]	0-127 [MSB], 0-16383[MSB,LSB]
FILTER RESONANCE	21 [MSB], 53 [LSB]	0-127 [MSB], 0-16383[MSB,LSB]
FILTER KB AMT	22 [MSB], 54 [LSB]	0-127 [MSB], 0-16383[MSB,LSB]
FILTER EG ATTACK TIME	23 [MSB], 55 [LSB]	0-127 [MSB], 0-16383[MSB,LSB]
FILTER EG DECAY TIME	24 [MSB], 56 [LSB]	0-127 [MSB], 0-16383[MSB,LSB]
FILTER EG SUSTAIN TIME	25 [MSB], 57 [LSB]	0-127 [MSB], 0-16383[MSB,LSB]
FILTER EG RELEASE TIME	26 [MSB], 58 [LSB]	0-127 [MSB], 0-16383[MSB,LSB]
FILTER EG AMT	27 [MSB], 59 [LSB]	0-127 [MSB], 0-16383[MSB,LSB]
AMP EG ATTACK TIME	28 [MSB], 60 [LSB]	0-127 [MSB], 0-16383[MSB,LSB]
AMP EG DECAY TIME	29 [MSB], 61 [LSB]	0-127 [MSB], 0-16383[MSB,LSB]
AMP EG SUSTAIN TIME	30 [MSB], 62 [LSB]	0-127 [MSB], 0-16383[MSB,LSB]
AMP EG RELEASE TIME	31 [MSB], 63 [LSB]	0-127 [MSB], 0-16383[MSB,LSB]
BANK SELECT [LSB]	32	0 = PRESET BANKS 1...8, 1 = PRESET BANKS 9...16
HOLD PEDAL/SUSTAIN	64	0 = OFF / 64 = ON
GLIDE	65	0 = OFF / 64 = ON
ARPEGGIATOR LATCH	69	0 = OFF / 64 = ON
MOD 1 OSC 1/2 SEL	70	0 = OSC1 + OSC2, 43 = OSC1, 85 = OSC2
MOD 1 SOURCE	71	0 = TRIANGLE LFO, 21 = SQUARE LFO, 43 = SAW LFO, 64 = RAMP LFO, 85 = S&H LFO, 107 = F.EG/PGM
MOD 2 SOURCE	72	0 = TRIANGLE LFO, 21 = SQUARE LFO, 43 = SAW LFO, 64 = RAMP LFO, 85 = S&H LFO, 107 = F.EG/PGM

CONTROL/PARAMETER	MIDI CC #	CC VALUE RANGE
ARP ON/OFF	73	0 = OFF / 64 = ON
OSC 1 OCTAVE	74	0 = 16', 32 = 8', 64 = 4', 96 = 2'
OSC 2 OCTAVE	75	0 = 16', 32 = 8', 64 = 4', 96 = 2'
LFO 1 RANGE	76	0 = Low Range, 43 = Med Range, 85 = Hi Range
OSC 2 HARD SYNC ON/OFF	77	0 = OFF / 64 = ON
LFO 2 RANGE	78	0 = Low Range, 43 = Med Range, 85 = Hi Range
FILTER EG KB AMT	79	0 - 127
AMP EG KB AMT	80	0 - 127
OSC KB RESET ON/OFF	81	0 = OFF / 64 = ON
FILTER EG RESET	82	0 = OFF / 64 = ON
AMP EG RESET	83	0 = OFF / 64 = ON
<RESERVED PORTAMENTO CONTROL>	84	
GLIDE TYPE	85	0 = LCR, 43 = LCT, 85 = EXP
FILTER EG VEL AMT	86	0 - 127
AMP EG VEL AMT	87	0 - 127
MOD 2 OSC 1/2 SEL	88	0 = OSC1 + OSC2, 43 = OSC1, 85 = OSC2
KB OCTAVE	89	0 = -2 Oct, 26 = -1 Oct, 51 = +0 Oct, 77 = +1 Oct, 102 = +2 Oct
MOD 1 DEST	91	0 = LF02 Rate, 18 = VCA Level, 37 = OSC1 Wave, 55 = OSC1 + OSC2 Wave, 73 = OSC2 Wave, 91 = Noise Level, 110 = EG Time/PGM
MOD 2 DEST	92	0 = LF01 Rate, 18 = VCA Level, 37 = OSC1 Wave, 55 = OSC1 + OSC2 Wave, 73 = OSC2 Wave, 91 = Noise Level, 110 = EG Time/PGM
LFO 1 KB RESET	93	0 = OFF / 64 = ON
GLIDE LEGATO	94	0 = OFF / 64 = ON
LFO 2 KB RESET	95	0 = OFF / 64 = ON
<RESERVED DATA INCREMENT>	96	
<RESERVED DATA DECREMENT>	97	
<RESERVED NRPN LSB>	98	
<RESERVED NRPN MSB>	99	
<RESERVED RPN LSB>	100	
<RESERVED RPN MSB>	101	
GLIDE DEST OSC 1/2/BOTH	102	0 = OSC1 + OSC2, 43 = OSC1, 85 = OSC2
FILTER EG DELAY	103	0-127
AMP EG DELAY	104	0-127
FILTER EG HOLD	105	0-127

CONTROL/PARAMETER	MIDI CC #	CC VALUE RANGE
AMP EG HOLD	106	0-127
PITCH BEND UP AMOUNT	107	0..+24 SEMITONES
PITCH BEND DOWN AMOUNT	108	0..+24 SEMITONES
FILTER SLOPES (POLES)	109	0 = -6dB, 32 = -12dB, 64 = -18dB, 96 = -24dB
OSC DUO MODE ON/OFF	110	0= OFF / 64 = ON
KB CTRL LO/HI	111	0 = NEITHER, 32 = LO, 64 = HI
FILTER EG MULTI TRIG	112	0 = OFF / 64 = ON
AMP EG MULTI TRIG	113	0 = OFF / 64 = ON
OSC 1 LEVEL	114	0-127
OSC 1 SUB LEVEL	115	0-127
OSC 2 LEVEL	116	0-127
NOISE LEVEL	117	0-127
FEEDBACK/EXT LEVEL	118	0-127
KB TRANSPOSE	119	RECEIVE ONLY: -12...+13 SEMITONES
LOCAL CONTROL ON/OFF	122	0 = OFF / 127 = ON
ALL NOTES OFF	123	

NRPN CHART

Non Registered Parameter Numbers allow for a much higher number of unique control messages (16,000+).

Since the Subsequent 37 has over 150 parameters saved with each sound, it is not possible to assign a standard MIDI CC to every parameter. For complete MIDI output from every panel knob and button, you will need to set the KNB NRPN/CC parameter to NRPN mode.

NOTE: Not every audio production software allows easy editing of NRPN messages, so you may prefer CC output for ease of use.

PARAMETER NAME	VALUE RANGE	NRPN	NRPN MSB (CC 99)	NRPN LSB(CC 98)
MOD WHEEL	16384	402	3	18
ARP RATE	16384	403	3	19
ARP SYNC	2	404	3	20
ARP RANGE	7	405	3	21
ARP BACK FORTH	2	406	3	22
ARP BF MODE	2	407	3	23
ARP INVERT	2	408	3	24
ARP PATTERN	6	409	3	25
ARP RUN	2	410	3	26
ARP LATCH	2	411	3	27
ARP GATE LEN	16384	412	3	28
ARP CLK DIV	21	413	3	29
(RESERVED)		414	3	30
(RESERVED)		415	3	31
ARP STEP 1 RESET	2	416	3	32
GLIDE TIME	16384	417	3	33
GLIDE OSC	3	418	3	34
GLIDE TYPE	3	419	3	35
GLIDE GATE	2	420	3	36
GLIDE LEGATO	2	421	3	37
GLIDE ON	2	422	3	38
LFO 1 RATE	16384	423	3	39
LFO 1 RANGE	3	424	3	40
LFO 1 SYNC	2	425	3	41
LFO 1 KB RESET	2	426	3	42
LFO 1 CLK DIV	21	427	3	43
LFO 1 CLK SRC	2	428	3	44
(RESERVED)		429	3	45
LFO 1 KB TRACK	16384	430	3	46
(RESERVED)		431	3	47
(RESERVED)		432	3	48
(RESERVED)		433	3	49
		434	3	50

PARAMETER NAME	VALUE RANGE	NRPN	NRPN MSB (CC 99)	NRPN LSB(CC 98)
(RESERVED)		434	3	50
MOD 1 MWHL AMT	16384	435	3	51
MOD 1 VELOCITY AMT	16384	436	3	52
MOD 1 PRESSURE AMT	16384	437	3	53
MOD 1 CTL4 AMT	16384	438	3	54
(RESERVED)		439	3	55
MOD 1 SOURCE	6	440	3	56
MOD 1 PGM SRC	8	441	3	57
MOD 1 DEST	7	442	3	58
MOD 1 PGM DEST	89	443	3	59
MOD 1 PGM AMT	16384	444	3	60
MOD 1 PITCH AMT	16384	445	3	61
MOD 1 FILTER AMT	16384	446	3	62
MOD 1 PITCH DEST	3	447	3	63
LFO 2 RATE	16384	448	3	64
LFO 2 RANGE	3	449	3	65
LFO 2 SYNC	2	450	3	66
LFO 2 KB RESET	2	451	3	67
LFO 2 CLK DIV	21	452	3	68
LFO 2 CLK SRC	2	453	3	69
(RESERVED)		454	3	70
LFO 2 KB TRACK	16384	455	3	71
(RESERVED)		456	3	72
(RESERVED)		457	3	73
(RESERVED)		458	3	74
(RESERVED)		459	3	75
MOD 2 MWHL AMT	16384	460	3	76
MOD 2 VELOCITY AMT	16384	461	3	77
MOD 2 PRESSURE AMT	16384	462	3	78
MOD 2 CTL4 AMT	16384	463	3	79
(RESERVED)		464	3	80
MOD 2 SOURCE	6	465	3	81
MOD 2 PGM SRC	8	466	3	82
MOD 2 DEST	7	467	3	83
MOD 2 PGM DEST	89	468	3	84
MOD 2 PGM AMT	16384	469	3	85
MOD 2 PITCH AMT	16384	470	3	86
MOD 2 FILTER AMT	16384	471	3	87
MOD 2 PITCH DEST	3	472	3	88
(RESERVED)		473	3	89

PARAMETER NAME	VALUE RANGE	NRPN	NRPN MSB (CC 99)	NRPN LSB(CC 98)
(RESERVED)		474	3	90
(RESERVED)		475	3	91
(RESERVED)		476	3	92
(RESERVED)		477	3	93
(RESERVED)		478	3	94
OSC 1 OCTAVE	4	479	3	95
OSC 1 WAVE	16384	480	3	96
OSC 2 HARD SYNC	2	481	3	97
OSC KB RESET	2	482	3	98
OSC 2 OCTAVE	4	483	3	99
OSC 2 WAVE	16384	484	3	100
OSC 2 KB CTRL	3	485	3	101
OSC 2 DUO MODE	16384	486	3	102
OSC 2 FREQUENCY	3	487	3	103
OSC 2 BEAT	2	488	3	104
OSC 1 LEVEL	2	489	3	105
OSC 1 ON	21	490	3	106
SUB OSC ON	2	491	3	107
SUB OSC LEVEL	16384	492	3	108
OSC 2 LEVEL	16384	493	3	109
OSC 2 ON	2	494	3	110
NOISE ON	2	495	3	111
NOISE LEVEL	16384	496	3	112
FB EXT LEVEL	16384	497	3	113
FB EXT ON	2	498	3	114
FILTER CUTOFF	16384	499	3	115
FILTER RESONANCE		500	3	116
FILTER DRIVE	16384	501	3	117
FILTER SLOPE	4	502	3	118
FILTER EG AMT	16384	503	3	119
FILTER KB AMT	16384	504	3	120
F EG ATTACK	16384	505	3	121
F EG DECAY	16384	506	3	122
F EG SUSTAIN	16384	507	3	123
F EG RELEASE	16384	508	3	124
F EG DELAY	16384	509	3	125
F EG HOLD	16384	510	3	126
F EG VEL AMT	16384	511	3	127
F EG KB TRACK	16384	512	4	0
F EG MULTI TRIG	2	513	4	1

PARAMETER NAME	VALUE RANGE	NRPN	NRPN MSB (CC 99)	NRPN LSB(CC 98)
F EG RESET	2	514	4	2
F EG SYNC	2	515	4	3
F EG LOOP	2	516	4	4
F EG LATCH	2	517	4	5
F EG CLK DIV	2	518	4	6
(RESERVED)		519	4	7
F EG ATTK EXP	2	520	4	8
(RESERVED)		521	4	9
(RESERVED)		522	4	10
(RESERVED)		523	4	11
(RESERVED)		524	4	12

SERVICE AND SUPPORT INFORMATION

MOOG LIMITED WARRANTY

Moog warrants its products to be free of defects in materials or workmanship and conforming to specifications at the time of shipment. The Warranty Period is one year from the date of purchase. During the Warranty Period, any defective products will be repaired or replaced, at Moog's option, on a return-to-factory basis. This warranty covers defects that Moog determines are no fault of the user. If a product is no longer in production, and it has been more than five years since the product shipped from the Moog factory, it will be at Moog's discretion whether or not to honor the warranty without regard to customer's date of purchase.

The Moog Limited Warranty applies to USA purchasers only. Outside the USA the warranty policy and associated service is determined by the laws of the country of purchase and supported by our local authorized distributor. In countries outside of the USA, contact a Moog authorized distributor listed on our website (www.moogmusic.com) for service.

RETURNING YOUR PRODUCT TO MOOG MUSIC

You must obtain prior approval in the form of an RMA (Return Material Authorization) number from Moog Music before returning any product. To request an RMA number call us at (828) 251-0090 or email techsupport@moogmusic.com. The Subsequent 37 must be returned in its original packing. The warranty will not be honored if the product is not properly packed. Send the product to Moog Music Inc. with transportation and insurance charges paid.

MOOG MUSIC
160 Broadway St.
Asheville NC, 28801

WHAT WE WILL DO

Once received, we will examine the product for any obvious signs of user abuse or damage as a result of transport. If the product has been abused, damaged in transit, or is out of warranty, we will contact you with an estimate of the repair cost.

HOW TO INITIATE YOUR WARRANTY

Please initiate your warranty online at www.moogmusic.com/register. If you do not have web access please call (828) 251-0090 to register your instrument. Registering your instrument initiates your warranty, ensures you receive the latest software updates, and gets you the free editor/librarian.

CARING FOR THE SUBSEQUENT 37

Clean the Subsequent 37 with a soft, slightly moist cloth only – do not use solvents or abrasive detergents. Heed the safety warnings at the beginning of the manual. Don't drop the unit. If you are shipping your Subsequent 37 to the factory for servicing, we recommend using the original shipping carton, or an ATA approved road case.

AN IMPORTANT NOTE ABOUT SAFETY: Do not open the chassis. There are no user serviceable parts in the Subsequent 37. Maintenance of the Subsequent 37 synthesizer should be referred to qualified service personnel only.

SPECIFICATIONS

TYPE: Programmable Paraphonic Analog Synthesizer

SOUND ENGINE: 100% Analog

NUMBER OF KEYS: 37

TYPE OF KEYS: Semi-Weighted with After Pressure

CONTROLLERS: Pitch Bend, Mod Wheel, After Pressure, Velocity

POLYPHONY: Selectable Monophonic or Duophonic

SOUND SOURCES: 2 Variable Waveshape Oscillators, 1 Square Wave Sub Oscillator, 1 Analog Noise Generator, 1 External Input/Filter Feedback

OSCILLATOR CALIBRATION RANGE: 22Hz-6.8kHz. Guaranteed note range at 8' of Note 18 to 116

MOD SOURCES: Triangle, Square, Saw, Ramp, Sample & Hold, Filter EG/PGM

MOD DESTINATIONS: Osc 1 Pitch, Osc 2, Osc 1 & 2 Pitch, Filter, LFO Rate, VCA Level, Osc 1 Wave, Osc 2 Wave, Osc 1 & 2 Wave, Noise Level, EG Time, and Programmable Destinations

FILTER: 20Hz-20kHz Moog Ladder Filter w/ 6/12/18/24 dB/Oct Filter Slopes and MultiDrive

AUDIO INPUT: 1xTS

AUDIO OUTPUT: 1xTS, 1xTRS Headphone

PRESETS: 256 Presets - 16 Banks, 16 Patches per Bank

MIDI I/O: DIN In, Out, and MIDI over USB

CV/GATE INPUTS: Filter CV, Pitch CV, Volume CV, KB Gate

TRANSPOSITION: +/- 2 Octaves

LFO: 0.01Hz - 1000Hz

WEIGHT: 22LBS / 10KG

DIMENSIONS: 6.75" H x 26.375" W x 14.75 D / 17cm H x 68cm W x 37.5cm D

NOMINAL OPERATING TEMPERATURE: 10 - 35 C (50 - 95 F)

OPERATIONAL TEMPERATURE RANGE: 10 - 50 C (50 - 122 F)

INPUT VOLTAGE: 100 VAC - 240 VAC / 50 - 60 HZ / 13W

Specifications Subject To Change Without Notice

©2017 MOOG MUSIC INC.

Moog is a registered trademark of Moog Music Inc.

The Moog Wordmark is a registered trademark of Moog Music Inc.

The Moog Icon is a registered trademark of Moog Music Inc.

Subsequent 37 is a trademark of Moog Music Inc.

Copyright 8.24.2014 - 2017 Moog Music Inc. All rights reserved.

*Moog Music Inc.
160 Broadway St.
Asheville, NC 28801*

*Phone: 828.251.0090
Email: info@moogmusic.com
Website: www.moogmusic.com*

