

# Console 1

## User Manual



 **Softube**

Supporting VST/VST3/AU/AAX Native. Rev. Oct 11, 2016

## Softube User Manual

© 2007-2016. Amp Room, Console 1 is trademarks of Softube AB, Sweden. Softube is a registered trademark of Softube AB, Sweden. All visual and aural references to the Valley People Dyna-mite, Trident A-Range, Tonelux and Tilt are trademarks being made with written permission from PMI Audio. The Tonelux and Tilt logo, the Valley People, Dyna-mite and associated logos, and the Trident, A-Range and Triangle logo are trademarks of PMI Audio Group, used under license. Tube-Tech is a registered trademark of Lydkraft ApS, Denmark. EMI and Abbey Road are trademarks of EMI (IP) Limited. REDD, RS127 and RS135 are trademarks of EMI (IP) Limited. SSL, Solid State Logic, SL 4000 E, XL 9000 K are all trademarks of Solid State Logic, UK, used with written permission. All specifications subject to change without notice. All Rights Reserved.

Other company and product names mentioned herein are trademarks of their respective companies. Mention of third-party products is for informational purposes only and constitutes neither an endorsement nor a recommendation. Softube assumes no responsibility with regard to the performance or use of these products.

Softube products are protected by patents SE526523 and SE525332, and related patents/patent applications, including WO06054943, US11/667360, US20040258250, EP1492081, EP1815459, and JP2004183976.

Your rights to the software are governed by the accompanying software license agreement (End User License Agreement).

### Disclaimer

Every effort has been made to ensure that the information in this manual is accurate. However, there are a chance that we have made mistakes, and we hope that you understand that we are only humans. Please let us know about the mistake, and we'll fix it in the mix (or in the next version of this manual).

### Support

On the Softube website ([www.softube.com](http://www.softube.com)) you will find answers to common questions (FAQ) and other topics that might interest you.

Support questions can be posted at <http://www.softube.com>, where we will help you as fast as we can!

Web: [www.softube.com](http://www.softube.com)

E-mail: [info@softube.com](mailto:info@softube.com)

Phone: +46 13 21 1623 (9 am – 5 pm CET)

# Contents

<b>1</b>	<i>Introduction and overview</i>	5
	The SSL SL 4000 E Channel . . . . .	5
	Console 1 Compared to Traditional Mixers . . . . .	6
<b>2</b>	<i>Getting started</i>	9
	Setting Up Your First Console 1 Session . . . . .	9
	Input Section . . . . .	16
	Shape Section . . . . .	17
	Equalizer Section . . . . .	18
	Compressor Section . . . . .	20
	Output Section . . . . .	21
<b>3</b>	<i>Working with Console 1</i>	23
	Track Selection . . . . .	24
	On-Screen Display . . . . .	24
	The Input Section . . . . .	26
	Shape . . . . .	28
	Equalizer . . . . .	30
	Compressor . . . . .	32
	The Output section . . . . .	34
	Understanding Solo Safe . . . . .	35

<b>4</b>	<i>Useful Functions</i>	37	<b>7</b>	<i>Solid State Logic XL 9000 K</i>	57
	Select All Tracks . . . . .	37		VHD model included. . . . .	58
	Create a Group . . . . .	37		Extended gate and compressor options . . . . .	58
	Duplicate Track Settings . . . . .	39		Background . . . . .	59
	Load Presets . . . . .	40			
	Save Preset. . . . .	42	<b>8</b>	<i>British Class A</i>	61
	Organizing your presets . . . . .	42		Introduction . . . . .	61
	Default Presets . . . . .	43		Drive . . . . .	62
	History. . . . .	44		Equalizer . . . . .	62
	Renaming/Rearranging Tracks . . . . .	45		Compressor . . . . .	62
	Set Auto Display Delay. . . . .	46		Limiter. . . . .	63
	FFT . . . . .	46		Gate . . . . .	63
	Alerts . . . . .	46			
	Using Console 1 Without the Hardware . . . . .	46	<b>9</b>	<i>Summit Audio Grand Channel</i>	65
	Automation . . . . .	46		The Tone Sculpter . . . . .	65
<b>5</b>	<i>Customizing the Channel Strip</i>	49		EQF-100 Full Range Equalizer. . . . .	66
	Loading Other Channel Strips and Effects . . . . .	49		TLA-100A Tube Leveling Amplifier . . . . .	66
	Changing the Order of the Sections . . . . .	50		Different Kinds of Distortion . . . . .	66
	Using External Sidechain Signals . . . . .	50		Shape . . . . .	66
	View Options . . . . .	52		Input Filters . . . . .	66
<b>6</b>	<i>DAW Integration</i>	53	<b>10</b>	<i>Specifications, Requirements and Troubleshooting</i>	67
	Track Number. . . . .	53		Block Diagram . . . . .	68
	Track Name. . . . .	54		Troubleshooting . . . . .	69
	Integrated DAW Control . . . . .	54		Hardware Specifications . . . . .	70
	Disabling DAW Integration . . . . .	55	<b>11</b>	<i>END USER LICENSE AGREEMENT</i>	<i>lxxi</i>



# 1

## Introduction and overview

Softube Console 1 is a new type of audio mixer. It is used together with your favorite digital audio workstation (DAW), and just like a traditional mixing console, you can route any or all DAW tracks to Console 1 and mix them from within that system. This gives you access to Console 1's world class sounding effects sections and lets you control everything from the hardware unit, using physical knobs and buttons.

So what Console 1 gives you is the great sound that has made Softube world famous, in addition to a tactile and intuitive workflow that speeds up your mix work substantially compared to mouse mixing on the computer.

### The SSL SL 4000 E Channel

Included in your purchase is Softube's model of a Solid State Logic SL 4000 E, one of the most famous and coveted mixing consoles in the world. SL 4000 E consoles have been installed in hundreds of the world's leading studios, and it is said that Solid State

Logic's 4000 series have been used on more platinum selling records than all other console models combined! This is for good reason. The SL 4000 E has a signature sound that is transparent enough to work for all music styles, but still adds its touch of luxury. Things simply sound like a record when they've been run through the SL 4000 E.

With Console 1, you get the famous black knob E242 equalizer, the classic channel compressor, the very musical gate/expander and the sweet high/low cut filters from the SL 4000 E channel. We also modeled the unique harmonics, distortion and nonlinearities you get from running the SL 4000 E into overdrive. Controlled by Console 1's Drive knob, you can use it subtly on all channels to glue the mix together like a slightly overdriven SL 4000 E does, or not so subtly to add edge and presence to selected sounds.

In addition, you get Softube's unique Transient Shaper, which is not modeled off the Solid State Logic SL 4000 E or any other unit for that matter. Read more about Transient Shaper in "Shape" in Chapter 4.

Softube's model of the Solid State Logic SL 4000 E channel is only available as part of the Console 1 system and not as a single plug-in. Softube will continuously release more channel strip models

to be used with Console 1, that can be purchased separately.

## Console 1 Compared to Traditional Mixers

To understand what Console 1 is, it may be helpful to compare it to existing mixer types. There are quite a few differences between Console 1 and most traditional mixers—both digital and analog ones.

First of all, Console 1 is strictly made for mixing, it's not a recording mixer with microphone preamplifiers. With Console 1, you have access to one channel at the time, the one you have selected with the corresponding channel selector button on the hardware unit. This gives the hardware unit a small footprint, but still offers direct access to more functions and effects per channel compared to most physical mixing consoles—as mentioned in the previous section, equalizer, compressor, distortion, gate, high and low cut filters and our Transient Shaper. All Console 1 settings are saved with your DAW session for total recall, and each parameter can be automated using the hardware knobs. You can open a DAW session mixed using Console 1 without having the Console 1 hardware connected, and you can even adjust settings using the mouse if you happen to be away from your Console 1 hardware.

Furthermore, the Console 1 hardware has no on-board DSP power, all the audio processing takes place within your computer. This has several advantages compared to a physical mixer, such as portability, lower cost and no need for an external power supply—the Console 1 hardware is USB



Solid State Logic SL 4000 E was introduced in 1980 and is to this day used in a large number of high end studios all over the world. Softube's model includes the most sought after equalizer version, the black knob E242.

powered.

The Console 1 software is also very CPU efficient, but please refer to “General requirements” on page 67 to see if your computer is powerful enough to use with Console 1.

And obviously, most mixers are contained in one single hardware unit. The Console 1 system consists of three different components that work in tight integration: the hardware, the On-Screen Display and the DAW plug-in.

One might say there is also a fourth component, namely the channel strip or single effect you have loaded into the separate Console 1 tracks. If you're new to Console 1, the channel strip will be the SSL SL 4000 E that is included in the purchase. There will be more plug-in channel strips for Console 1 such as that one, that can be purchased separately. And you can also load other Softube plug-ins into the system. See “Loading Other Channel Strips and Effects” in Chapter 6 of this manual.







# 2

## Getting started

In order to install the required software and activate your license, first make sure your computer has internet access. Use any browser to visit the page

[www.softube.com/console1-install](http://www.softube.com/console1-install)

Here, you will be guided through all the necessary steps. You will be asked to enter the unique license code printed on the Quick Start guide that is enclosed in the Console 1 shipping box.

### **Setting Up Your First Console 1 Session**

When you have gone through the registration process on Softube's web site, you are ready to set up your basic Console 1 session. You may want to save this as a template session in your DAW, so you will not have to do this for every new piece of music you start working on. Please refer to your DAW's manual on how to save a template session, as well as any other steps mentioned below that refer to actions in your DAW.

1. Connect the Console 1 hardware to an unoccupied USB port on your computer. The Softube logo in your computer's control panel will turn from grey to black.
2. Launch your preferred digital audio workstation (DAW) application. Console 1 runs with any host that supports VST2, VST3, AAX and Audio Units plug-in formats
3. Launch an empty session in your DAW.
4. Insert the Console 1 plug-in on as many tracks as you like. We recommend inserting it on all single tracks, aux channels and buses.

The audio on any track where you have inserted the Console 1 plug-in will now be

routed into the Console 1 system and back to the same DAW channel. See next section for setting the correct track name and number.

## Track Name and Number

Many DAW hosts support automatic transfer of track name and number from the DAW host tracks to the corresponding Console 1 tracks. This means that any name you have given a track in the DAW host automatically appears on the corresponding track in the Console 1 mixer. Similarly, if the DAW host supports automatic transfer of track number, the number of the DAW track will be the same as the corresponding track in Console 1, so the track layout will be the same in Console 1 as in your DAW. This in turn means that if you decide to rearrange the track order in your DAW, this also gets reflected in the Console 1 mixer.

In order to verify this, you can open the Console 1 plug-in window on any channel in your DAW. In the lower right part of this window, you will see either “Auto” or “Manual”. “Auto” indicates that the track name and number is automatically transferred from your DAW to Console 1. In this case, you will now be able to open Console 1’s On-Screen Display (by pushing the Display On button in the top left corner of the hardware) and see all the tracks laid out and named just as they are in your DAW session.

However, some DAW hosts do not support automatic transfer of track name and number from the host to Console 1. In the case of Pro Tools and Logic Pro, these support automatic transfer of track name, but not number. This is the “Manual” case, which will be indicated in the lower right part of the Console 1 plug-in window. In this case, you will need to manually select to which Console 1 track the Console 1 plug-in routs the DAW channel’s audio, and possibly also manually enter the track name for it to display in the Console 1 system.

---

If your preferred DAW does not support automatic transfer of track number: When a Console 1 plug-in is instantiated on a DAW track, it will by default be placed on the lowest available track number. This means that it can be a good idea to launch the Console 1 plug-ins by starting on DAW track 1, which will then be placed on Console 1 track 1, then move on to DAW track 2, which will be placed on Console 1 track 2 (because this is now the lowest available track), etc. This should save you from most of the manual work of placing the Console 1 tracks in a way that corresponds to how they are laid out in the DAW.

---

---

If you want to turn off automatic track name/number or the Integrated DAW Control, please click “SETUP” in the plug-in (not the On-Screen Display). For more information, please see “Disabling DAW Integration” on page 55

---

Follow these steps to set the track name:

1. Open the Console 1 On-Screen Display.
2. Open Settings by pressing Shift and track selector 20 (Settings). Scroll down to “Rename Tracks” and click Solo/OK.
3. Select the first track with the track selector buttons, and enter the name in the dialog window. Hit OK.
4. Select the next track, and do the same thing.

Follow these steps to place a certain Console 1 track on a certain track number:

1. Open the Console 1 On-Screen Display.
2. Open Settings by pressing Shift and Track Selector 20 (Settings). Scroll down to “Rearrange Tracks” and click Solo/OK.
3. Select which track you want to move using the track selector buttons.
4. Select where you want to put it.
5. Select the next track you want to move, and repeat until you're done!

See details in “Renumber/rearrange Tracks” and “Rename Tracks” on page 45.

---

You can only put 1 instance of the Console 1 plug-in on each track if the DAW supports automatic track numbers.

---

## Integrated DAW Control

In **Presonus Studio One** and **Cakewalk SONAR**, vital DAW functions can be controlled right from the Console 1 hardware—allowing an even smoother workflow.

### Track Selection

Console 1 allows the DAW track selection to be reflected in Console 1, and vice versa.

### Volume and Pan

As always, the Console 1 **Output Volume** and **Pan** knobs can be used to control the corresponding settings in the Console 1 software—but they can also be switched over to control the pan knob and volume fader on the selected DAW track.

### Solo and Mute

The **Solo** and **Mute** can also be switched to control the selected DAW track or to control these settings in the Console 1 software.

### DAW Send Levels

Hold **SHIFT** and control the selected DAW track's send levels directly from the Console 1 hardware.

---

For more information regarding the Integrated DAW Control, please see “Integrated DAW Control” on page 54

---

## Solo Safe on Aux Channels and Buses

As mentioned above, we recommend that you insert the Console 1 plug-in on all your DAW channels, including single tracks, aux channels and buses. But in order for Console 1's **Solo** function to work as expected, you should set aux channels, effects send channels, subgroup buses and the master bus—essentially, any channels in your DAW mixer that are not single audio or software instrument tracks—to **Solo Safe**. If you are using an aux channel for the incoming sound of a Rewire sound source, such as Propellerheads Reason, this can however be viewed as an instrument track. We consequently recommend you do not set this to **Solo Safe**.

See “Understanding Solo Safe” on page 35 if you're interested in why this setting is needed for Console 1's **Solo** function to behave as expected. Otherwise, simply follow these steps:

- Open the Console 1 plug-in on all aux channels (except Rewire aux channels that handle incoming sound signals), effects channels, subgroup buses and the master bus in your DAW.
- Activate **Solo Safe** setting by clicking this button in the plug-in window.

Any time you press **Solo** on the Console 1 hardware, the text “SOLO SAFE” will appear in the On-Screen Display above any channel that has been set to **SOLO SAFE**.

**Track Number** This is automatically set to correspond to the DAW track, in DAWs that support this function. If your DAW does not support automatic transfer of the track number, click the number set this manually.

You can also press Shift + 20 (Settings) to to rename ro renumber tracks from the On-Screen Display. That is the preferred method, and is a lot easier to use.

**Track Name** This is automatically set to correspond to the DAW track, in DAWs that support this function. If your DAW does not support automatic transfer of the track name, click the name to set this manually.

**Show Knobs** Click to open an interface that resembles the Console 1 hardware. Here, you can adjust the settings using a computer mouse.

**Solo Safe** Clicking this excludes the track/channel from **Solo**. When another track is set to solo, **Solo Safe** channels will not be silenced. This option is recommended for all aux channels, subgroups and the master bus.

**Auto or Manual** Indicates if your DAW supports automatic transfer of track number and name, or if you need to set this manually.

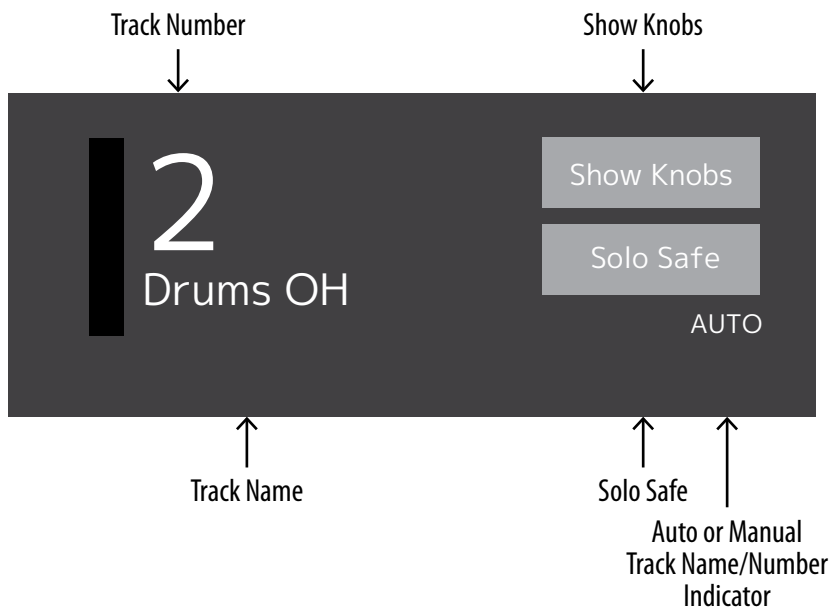

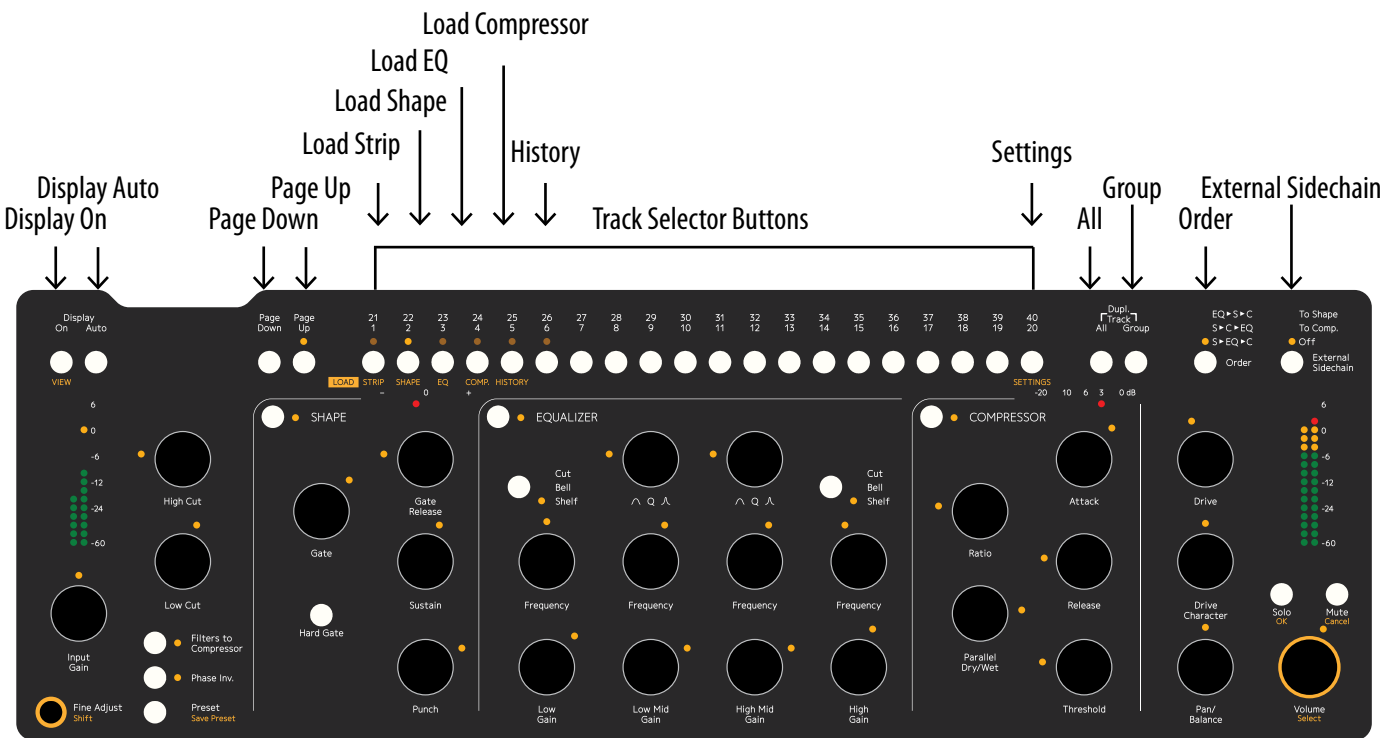

**Display On** Toggles Console 1's On-Screen Display on and off. Hold **Shift** and push **Display On** to select different view modes.

**Display Auto** Sets the On-Screen Display behavior to automatic mode. In this case, the display pops up every time you change a setting, and automatically goes away a few seconds after your latest adjustment.

**Page Up, Page Down** Select which bank of tracks the 20 channel selector buttons control. You can have a virtually unlimited number of banks and tracks. The **Page Up** LED will light up if there are tracks on a page above the current, and vice versa with the **Page Down** LED.

**Track selector buttons** Select the channel you want to adjust, of 1-20 (or 21-40, 41-60 etc, depending on what page you selected with the **Page Up** and **Page Down** buttons). The selector buttons for tracks 1-5 and 20 have alternate functions, accessible by holding **Shift**.

**Load Strip** Selector button for track 1 (or 21, 41, 61 etc, depending on what page you are on). Hold the **Shift/Fine Adjust** button to select a new channel strip to load into the selected track (if you have more than one Console 1 compatible channel strip).

**Load Shape** Selector button for track 2 (or 22, 42, 62 etc, depending on what page you are on). Hold the **Shift/Fine Adjust** button to select a new Shape plug-in to load into the selected track (if you have more than one Console 1 compatible plug-in that is suitable for the Shape section).

**Load EQ** Selector button for track 3 (or 23, 43, 63 etc, depending on what page you are on). Hold the **Shift/Fine Adjust** button to select a new equalizer to load into the selected track (if you have more than one Console 1 compatible equalizer).

**Load Compressor** Selector button for track 4 (or 24, 44, 64 etc, depending on what page you are on). Hold the **Shift/Fine Adjust** button to select a new compressor to load into the selected track (if you have more than one Console 1 compatible compressor).

**History** Selector button for track 5 (or 25, 45, 65 etc, depending on what page you are on). Hold the **Shift/Fine Adjust** button to activate the **History** function and undo your actions.

**Settings** Selector button for track 20 (or 40, 60, 80 etc, depending on what page you are on). Hold the **Shift/Fine Adjust** button to enter the Settings menu.

**All** Press and hold to select all tracks at once. Any adjustments made while you hold this will affect all tracks. Press and hold together with **Group** button to duplicate settings from one track to another, or several others.

**Group** Press and hold while you select two or more tracks to form a group. Hold together with **All** button to duplicate settings from one track to another, or several others.

**Order** Changes the order of the three main effects sections. Default state is Shape into equalizer into compressor (s → EQ → c). Press repeatedly to toggle between this state, or shape, compressor and equalizer (s → c → EQ) or equalizer, shape and compressor (EQ → s → c).

**External Sidechain** Determines whether an incoming external sidechain signal should have no effect (OFF), be routed to the compressor sidechain (TO COMP) or to the sidechain of the gate part in the Shape section (TO GATE).

## Input Section

**Input Gain** Adjusts the gain of the incoming signal of the selected track.

**Input Gain meter** Displays the signal level after the **Input Gain**.

**High Cut** Sets the cutoff frequency of the **High Cut** filter. Turn fully clockwise to bypass entirely (leave the signal intact). When **Filters to Compressor** is activated, the filter is applied to the compressor's sidechain signal.

**Low Cut** Sets the cutoff frequency of the **Low Cut** filter. Turn fully counterclockwise to bypass entirely (leave the signal intact). When **Filters to Compressor** is activated, the filter is applied to the compressor's sidechain signal.

**Fine Adjust/Shift** Hold while you adjust a knob to make the parameter change in smaller increments, or to access the extra functions labeled in orange.

**Filters to Compressor** Shifts the High and Low Cut filters from their default state (affecting the audio signal) to affecting the side-chain signal of the compressor.

**Phase Invert** Inverts the phase (polarity) of the selected channel.

**Preset/Save preset** Calls up the Presets menu. Press this while holding **Shift** to save the current settings as a preset.

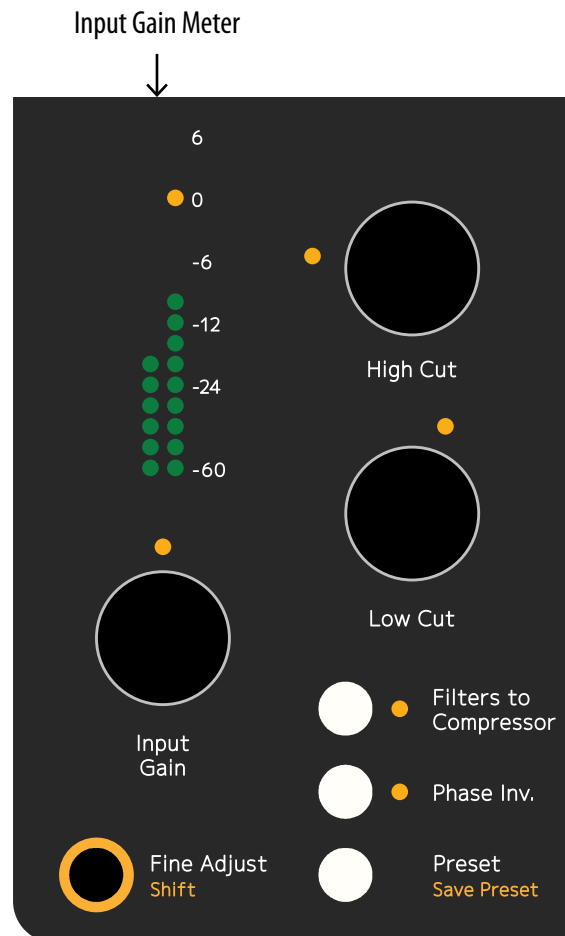



## Shape Section

**Shape activation** Activates or bypasses the Shape section.

**Shape section meter** Displays the level changes caused by the Shape section.

**Gate** Sets the threshold level of the gate.

**Gate Release** Sets the release time of the gate.

**Hard Gate** Toggles between **HARD GATE** and **SOFT GATE** settings.

**Sustain** Turned clockwise from its center position, lengthens the sustain of the signal. Turned counterclockwise from its center position, shortens the sustain of the signal.

**Punch** Turned clockwise from its center position, makes transients stronger. Turned counterclockwise, makes transients softer.

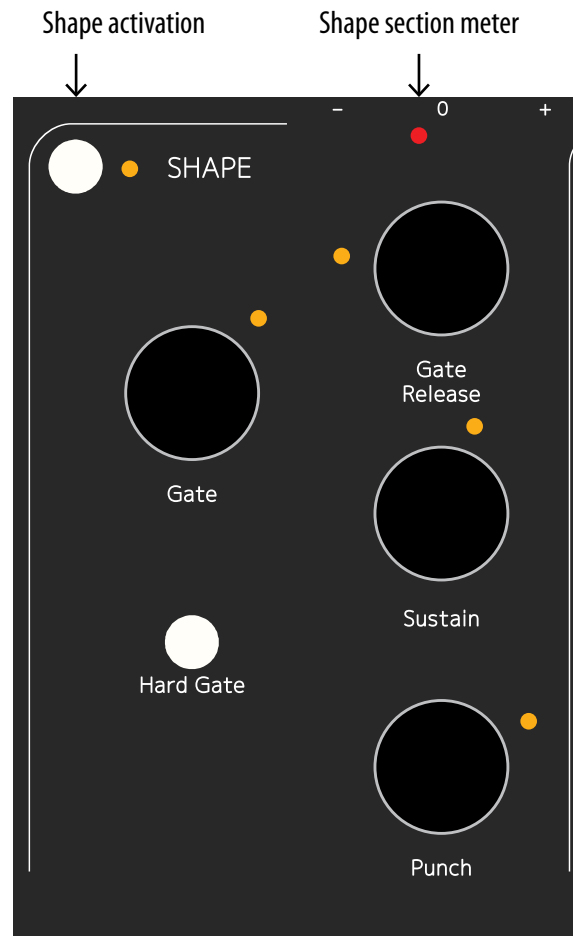

## Equalizer Section

**EQ activation** Activates or bypasses the equalizer section.

### Low Band

**Cut/Bell/Shelf** Sets the operating mode of the equalizer's low band.

**Frequency** Sets the operating frequency of the equalizer's low band.

**Low Gain** Turned clockwise from its center position, boosts the gain of the equalizer's low band. Turned counterclockwise from its center position, cuts the gain of the equalizer's low band.

### Low Mid Band

**Q** Sets the width of the equalizer's low mid band.

**Frequency** Sets the operating frequency of the equalizer's low mid band.

**Low Mid Gain** Turned clockwise from its center position, boosts the gain of the equalizer's low mid band. Turned counterclockwise from its center position, cuts

EQ activation

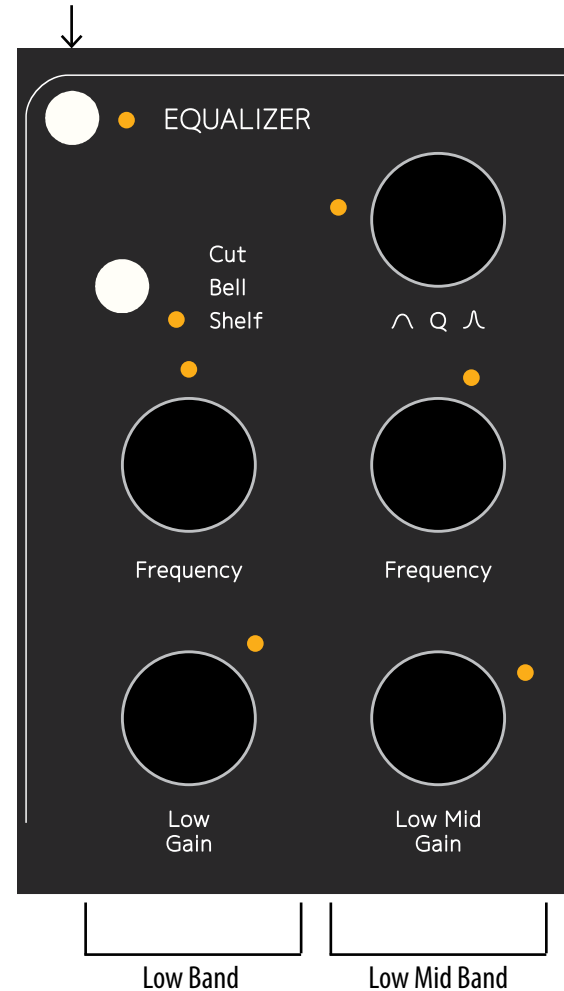

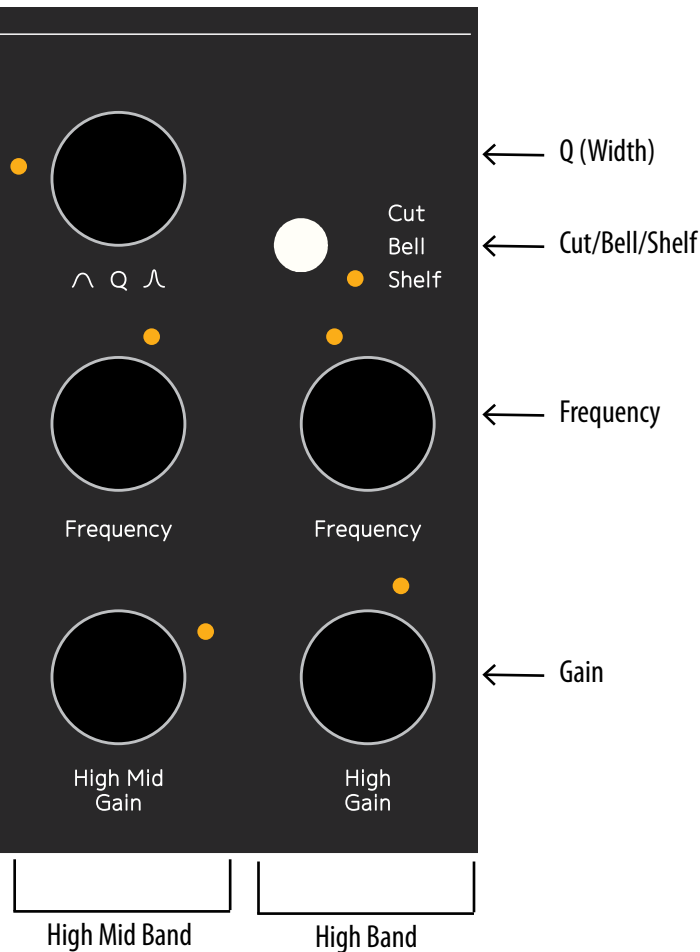

the gain of the equalizer's low mid band.

## High Mid Band

**Q** Sets the width of the equalizer's high mid band.

**Frequency** Sets the operating frequency of the equalizer's high mid band.

**High Mid Gain** Turned clockwise from its center position, boosts the gain of the equalizer's high mid band. Turned counterclockwise from its center position, cuts the gain of the equalizer's high mid band.

## High Band

**Cut/Bell/Shelf** Sets the operating mode of the equalizer's high band.

**Frequency** Sets the operating frequency of the equalizer's high band.

**High Gain** Turned clockwise from its center position, boosts the gain of the equalizer's high band. Turned counterclockwise from its center position, cuts the gain of the equalizer's high band.

## Compressor Section

**Compressor activation** Activates or bypasses the compressor section.

**Gain Reduction meter** Displays the gain reduction caused by the compressor.

**Ratio** Sets the compressor's ratio.

**Attack** Sets the compressor's attack time.

**Parallel Dry/Wet** Sets the relative level of the compressed and uncompressed signal.

**Release** Sets the compressor's release time.

**Threshold** Sets the compressor's threshold.



## Output Section

**Drive** Sets the level of the **Drive**/distortion function. Turn fully counterclockwise to bypass.

**Drive Character** Sets the **Drive**/distortion character.

**Pan/Balance** Sets the left-right placement of mono-to-stereo tracks, or the balance between left and right channels for stereo tracks. Pan is disabled for mono tracks.

**Solo/OK** Sets the selected tracks in Solo mode (all other channels are silenced, with the exception of tracks that have been set to **Solo Safe** in the Console 1 plug-in). In menus and dialog windows, the **Solo** button works as an "OK" button and confirms your choice in a currently opened menu.

**Mute/Cancel** Silences the selected track. In menus and dialog windows, the Mute button works as a "Cancel" button and cancels your choice in a currently opened menu.

**Volume/Select** Sets the output volume of the selected track. When **Shift** is pressed and held, use this knob to scroll in menus.

**Output level meter** Displays the output level of the signal that will be routed back to the DAW channel.

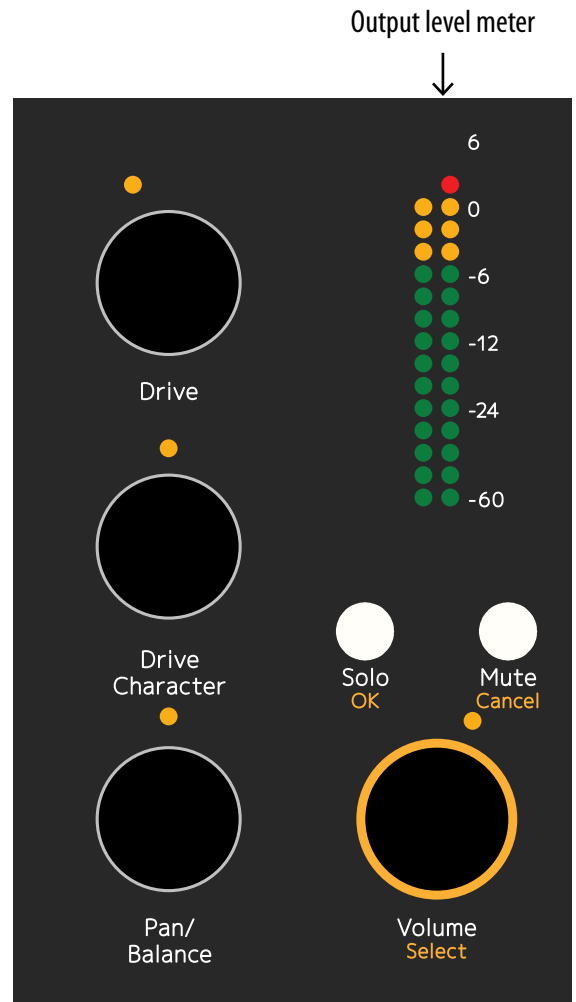





Hammersnail Sonic Research, London, UK

# 3 Working with Console 1

Console 1 has been designed to not only give you world class sound, but also extreme ease of use. Once you have everything set up, the basic workflow of Console 1 is as follows

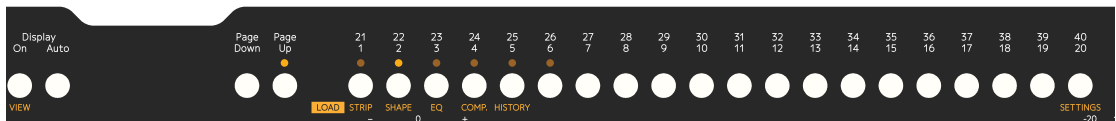

- Select a track by pressing the corresponding **Track Selector** button.
- Use the knobs to adjust the settings.
- Select another track.
- Adjust the settings.
- Repeat until your mix is great.

With that said, there are of course a few more details to look into. We will start by looking into track selection and handling, and then move on to a walkthrough of Console 1's effects sections.

## Track Selection

The DAW tracks where you have initiated the Console 1 plug-in will be routed to the corresponding Console 1 track, as set in the Console 1 plug-in (See “Track Name and Number” on page 10). Pressing a **Track Selector** button on the hardware selects the corresponding track, and all knobs and buttons now control that track. The LEDs above the track selector buttons will light up if a DAW channel is routed to that track, and the LED of the currently selected track will light up brightly. LEDs next to each button and around each knob show the respective parameter’s current setting.



Parameter with LED showing the setting.

In the meter bridge of the On-Screen Display, you will see the track numbers and names. When music is played back, the respective track levels will be displayed here. The selected track will be highlighted in the meter bridge, and the settings of that track are reflected graphically and numerically in the On-Screen Display’s effect sections.

If you have more than 20 tracks in your mix, use the **Page Up** and **Page Down** buttons to access higher numbered tracks, in banks of 20 tracks each. The total number of available tracks is only limited by your computer’s CPU resources.

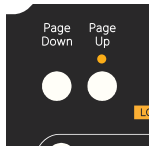

Page Up and Page Down buttons

If there are tracks on another page than the one you are currently on, the LEDs above the **Page Up** and **Page Down** buttons will show if these tracks are below and/or above the current page. If the currently selected track is on another page, the LED guiding to that page will be bright.

---

About CPU handling: Since Console 1 runs entirely on your computer’s CPU, a few things should be noted on the CPU usage. Most importantly, Console 1’s software part is unusually CPU efficient, and you should be able to run most sessions on today’s computers. It should also be noted that when you initiate the Console 1 plug-in on a DAW track, the default state of the Console 1 channel strip is to have all effects sections bypassed. In this state, the CPU usage is barely measurable. But of course, you still have access to functions like Solo, Mute, Volume, Phase Invert etc. Therefore, it is a good idea to create a DAW template with Console 1 active on all tracks and buses, even if you don’t plan to use any of the system’s effects. You get control over all tracks, at virtually no expense.

---

## On-Screen Display

You can toggle on and off Console 1’s On-Screen Display with the **Display On** button on the Console 1 hardware. Turning the On-Screen Display off will reveal whatever is behind it on your computer screen—in most cases, this will be your DAW windows.

There is also an automatic mode that you activate by pressing the **Auto** button next to **Display On**. With this active, the On-Screen Display appears automatically every time you adjust a setting on the Console 1 hardware, and then disappears automatically after a few seconds, revealing whatever is behind the On-Screen Display.

If you have an extra computer screen, you can drag the On-Screen Display window there, just as any window. The On-Screen Display window can also be resized to your liking, by grabbing a corner of the window and dragging it as you wish.

---

Many people find that modern DAWs and plug-ins provide them with too much graphical information. Indeed, trusting your eyes over your ears is a well-known pitfall when mixing. Therefore, Console 1 works just as well with



the On-Screen Display turned off. You still select a channel and adjust the settings the same way. On the hardware, the LED rings around each knob show the current setting, so in a way, working like this resembles working on a classic analog console.

You can also choose to work with different types of views on the On-Screen Display, which you toggle through by pressing **Shift + On** on the hardware.

The available view modes are:

1. Frequency Analyzer (default)
2. No Frequency Analyzer
3. Knobs View (no graphs)
4. Large Meter Bridge
5. Small Meter Bridge

For more information on these modes, please see “” on page 51.



The On-Screen Display shows all settings for the current track, as well as output meters for the tracks on the current page.

## Track Meters

The track meters show the metering (output volume) for all tracks on the current page, as well as the combined gain reduction from both the Shape and Compressor sections. It also shows if a track has been soloed, muted, or indirectly muted by another soloed track. If Solo Safe is enabled for that track, a Solo Safe text will appear as soon as at least one track is being soloed.

The currently selected track is highlighted.

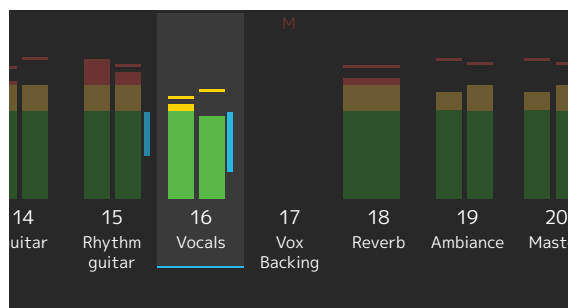

The On-Screen Display shows a/v settings for the current track, as well as output meters for the tracks on the current page.

## The Input Section

In the Input Section of Console 1, you'll find the **Input Gain** knob. This adjusts the gain (volume level) of the incoming sound. Its setting is displayed numerically in the On-Screen Display. The input gain meter displays the signal level post the Input Gain knob—meaning adjustments to the Input Gain setting will be reflected in what level the meter displays. In most cases, it is a good idea to adjust the level so the signal's peaks reach between  $-12$  and  $-6$  dBFS.

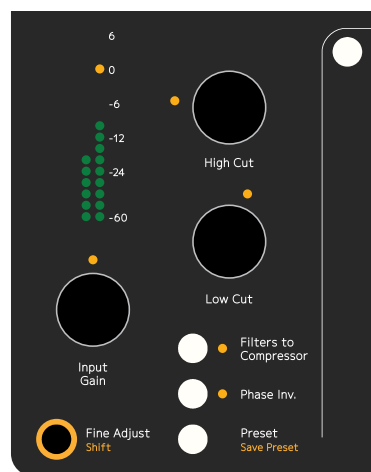

Input section on the Console 1 hardware.

## High and Low Cut

The sweepable **High Cut** and **Low Cut** filters can be used to narrow down the frequency span of the signal. The filters' cutoff frequencies will be reflected numerically in the input section of the On-Screen Display, and will affect the graphical equalizer curve.

Many mix engineers have taken the habit of using **Low Cut** on most sound sources, except for bass instruments and kick drums, to remove unwanted low frequency rumble from the signal. **High Cut**

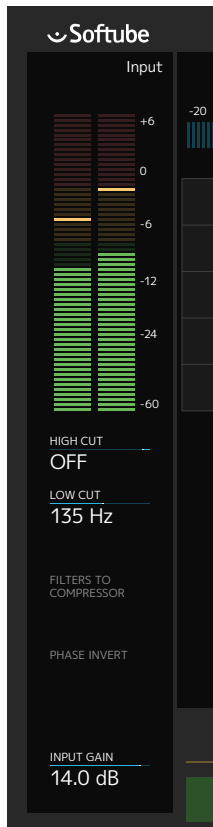

Input section on the On-Screen Display.

anner, the same applies to the **High Cut** filter when its knob is turned fully clockwise.

## Filters to Compressor

By pressing the **Filters to Compressor** button, the High and Low Cut filters will no longer affect the sound source directly, but instead the sidechain signal of the compressor. Read more about this in “Filtering the Compressor Sidechain” on page 33.

is useful for removing unwanted hiss from signals that do not have very much high frequency content anyways.

It is of course entirely possible to use the **High** and **Low Cut** filters in a more creative manner—to not just clean up unwanted rumble and hiss, but to actually affect the sound source to better fit in the mix. The slope and character of the High Cut and Low Cut filters are determined by what channel strip has been loaded into the track. So in the case of the included SSL SL4000E, the High and Low Cut filters are modeled off that console. We have however extended their working range quite radically.

With the **Low Cut** knob turned fully counterclockwise, the filter is entirely bypassed. In a similar man-

## Phase Invert

**Phase Invert** inverts the phase (polarity) of the signal, so that all negative parts of the signal’s waveform become positive and vice versa. This is useful to correct issues where for example a microphone cable has been miswired and the polarity inverted. It may (or may not) also improve the result when combining two microphones that are picking up the same sound source, such as top and bottom microphones on a drum or several microphones on the same guitar cabinet. When Phase Invert is active, the LED next to the button lights up, and it is also indicated in the On-Screen Display.

## Fine Adjust/Shift

Holding the **Fine Adjust/Shift** button will make any settings you can adjust with a knob move in smaller increments. You can see the difference by following the numeric setting of a parameter in the On-Screen Display while holding and releasing the Fine Adjust button.

---

By adjusting a knob slowly it will automatically be adjusted with smaller increments, just like the “Fine Adjust” mode. If you need even better resolution, just move the knob slowly while holding “Fine Adjust”.

---

Holding Fine Adjust/Shift also gives you access to all functions screen printed in orange on the hardware.

## Shape

The Shape section is a unique combination of two different types of effect, an expander/gate and Softube's own *Transient Shaper*. Toggle on and off the section with the button in the top left corner of the section. Turning the section on will light up the LED next to the Shape button and light up the Shape section in the On-Screen Display. The section's meter—both on the hardware and in the On-Screen Display—will show the gain increase or reduction caused by the section's processing of the sound, and you will also see a graphical curve in the On-Screen Display that represents the effect taking place.

An expander/gate is most commonly used to automatically remove unwanted portions of the recording. A common example is to use it on single drum tracks, where the gate opens and lets the sound through every time the drum is hit, but closes and makes the channel go silent between the drum hits, removing leakage from the rest of the drum kit. But a gate can also be used to for example

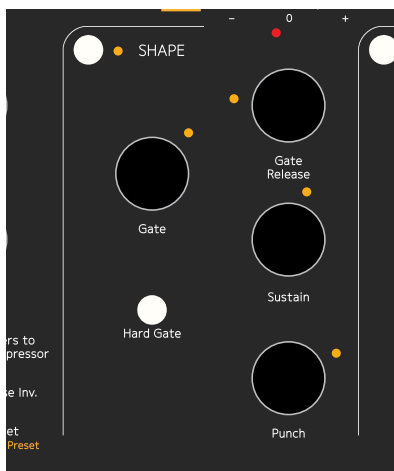

Shape section on the Console 1 hardware.



Shape section on the On-Screen Display.

shorten room reverberation in a recording, making the room appear smaller and improving separation between instruments.

## Gate

The gate part of the Shape section has three parameters. The **Gate** setting determines the threshold level. The gate will open and let through any portion of the sound that exceeds this level, and close (not letting sounds through) when the signal is below it.

Pay attention when you

set this level. If it's set too high, the gate will not open every time you wish it would, meaning you will accidentally remove sounds you intended to keep. If it's set too low, the gate may instead open to sounds you intended to remove.

## Gate Release

The **Gate Release** setting determines the time it takes for the gate to close after it has opened. For percussive material where you want just the hits and not much in between, you may want a shorter release time. But for a live recorded vocal, a too short release time may result in the gate abruptly shutting off the vocal sound, and remove low level vocal sounds you may would have liked to keep.

## Hard Gate

The **Hard Gate** button toggles between two different gate behaviors. With **Hard Gate** engaged, the gate strictly shuts off any sound below the threshold level. With it disengaged, the gate will act as an expander. This is essentially a gate that does not completely turn off the sound below the threshold, but instead turns it down somewhat in level. This may yield a more natural sound in some cases, compared to a hard gate. When the **Hard Gate** setting is activated, the LED next to the **Hard Gate** button lights up, as well as the **Hard Gate** indicator in the On-Screen Display.

## Sustain

The **Sustain** and **Punch** settings control the Transient Shaper part of the Shape section. When the **Sustain** knob is turned clockwise from its center position, the sound's sustain is increased, for example making single drums sound larger and more extended. Turned counterclockwise, the opposite happens: the sustain decreases, making sounds shorter and smaller.

## Punch

**Punch** strengthens or softens the sound's transient, the onset of a sound. When the **Punch** button is turned clockwise from the center position, the transient will get stronger, resulting in a more spiky and attention-grabbing sound. Turned counterclockwise, the transient will get softer, making the sound's onset more rounded and unobtrusive.

## Equalizer

An equalizer alters the frequency content of the sound, giving you detailed control of the sound's tone. The Console 1 equalizer has four parametric bands. Toggle on or off the entire section with the button in the top left corner of the section. The LED next to the button will light up when the section is active, and the entire section will light up in the On-Screen Display. All the equalizer settings mentioned below are displayed numerically in the On-Screen Display, as well as in the equalizer's graphical curve.

All four bands have a **Gain** setting. When the buttons are turned clockwise from their center position, these will boost the gain of the respective frequency bands. Turned counterclockwise, they will do the opposite and cut the gain of the respective frequency bands.

The four bands also each have a **Frequency** setting. These determine the center or cutoff frequencies of the respective frequency bands.

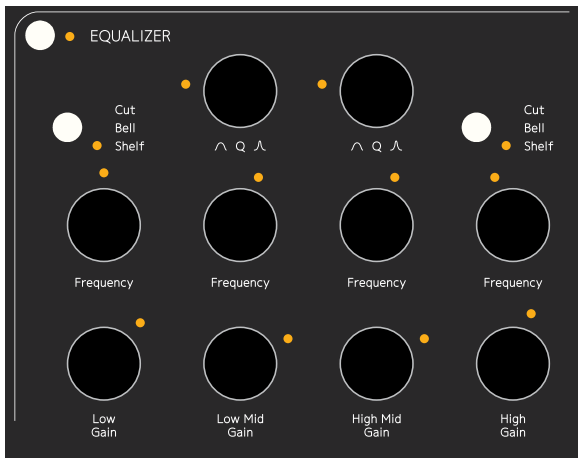

Equalizer section on the Console 1 hardware.

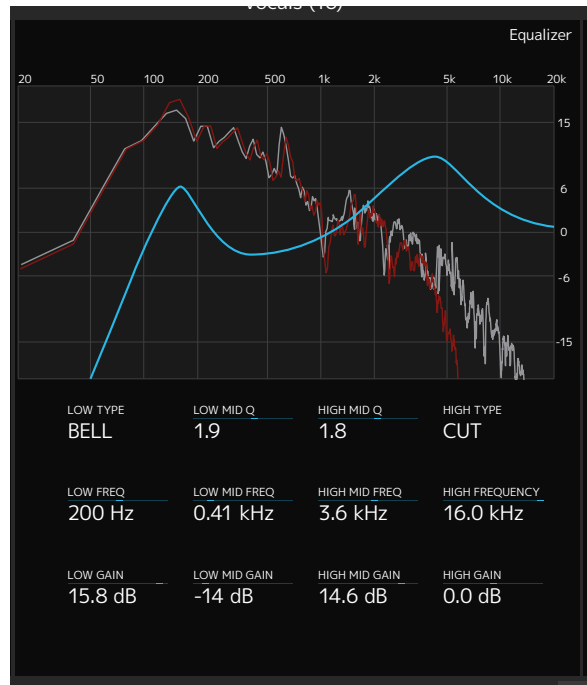

Equalizer section on the On-Screen Display.

### Low Mid and High Mid Bands

The Low Mid and High Mid bands have a **Q** setting each. These set the **Q** value of the equalizer curve, determining how wide or narrow range of frequencies the equalizer band will affect.

### Low and High Bands

The Low and High bands instead have a button that lets the user toggle between a **SHELF**, **BELL** or **CUT** shape of those filters. A shelf means that all frequencies below (in the case of **Low** filter) and above (in the case of the **High** filter) the cutoff frequency will be cut or boosted equally.

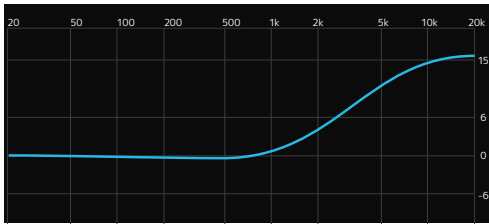

A high shelving filter.

A **BELL** curve means the EQ boosts or cuts the set center frequency and a range of frequencies above and below that, diminishing in strength the further from the center frequency it gets.

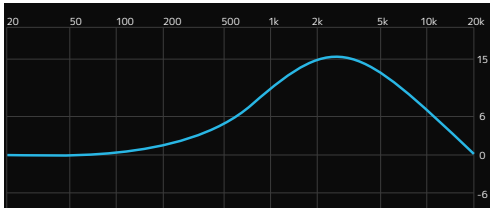

A broad high boost bell curve.

**CUT** means that the **High** and **Low** filters can double as high and low cut filters, just as the ones in the Input section. So these will be taking away anything below (in the case of **Low** filter) and above (in the case of the **High** filter) the cutoff frequency.

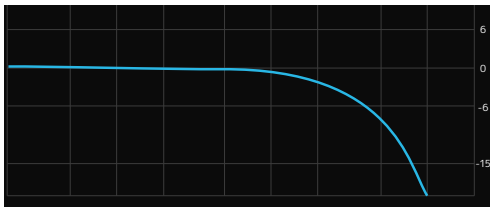

The high band set to "cut".

This is useful if you have chosen to use the **High** and **Low Cut** filters of Console 1's input section for the compressor's side chain but still want high and low cutting on the signal itself.

Please note that the graphical curve displays the actual equalizer response, calculated off the modeled analog circuitry. This curve may differ from the markings on the equalizer parameter functions, which is quite common for real world analog equalizers. The markings may not tell you the truth about what you really do when you twist the knobs, but Console 1's equalizer curve does!

## Compressor

A compressor is essentially a device that acts like an automatic volume control. When the level of the incoming signal rises above a certain level—the compressor’s threshold level—the compressor will start decreasing the output level. So the difference between the loudest and the softest parts of the sound will be made smaller—the sound will be compressed. Toggle on or off Console 1’s compressor section with the button in the top left corner of the section. The LED next to the button will light up when the section is active, and the entire section will light up in the On-Screen Display. The compressor’s current behavior is displayed in the graphical curve.

### Threshold

The **Threshold** setting determines the threshold level, above which the compressor will react and start decreasing the output level. A low threshold means the compressor affects most portions of the sound (the sound does not have to be very loud to

exceed the threshold), a high threshold means the compressor only affects the loudest parts of the signal.

---

Console 1’s Compressor section incorporates an **automatic make-up gain**, which compensates for the gain reduction the compressor causes by turning up the sound level. This applies to any compressor you load into the Compressor section, even though that function may not be part of the original standalone plug-in.

---

### Ratio

The **Ratio** setting determines by how much the output volume will be decreased when a sound is louder than the threshold level. For example, a 4:1 ratio means the sound will be reduced to a fourth of the level that exceeded the threshold. So if a sound exceeds the level by 4 dB the compressor will turn it down to 1 dB above the threshold level. If the sound exceeds the threshold by 8 dB, the compressor will turn it down to 2 dB above the threshold level. ∞:1 means that no sound that exceeds the threshold level will ever get any louder than that level. This is often referred to as limiting.

### Gain Reduction Meter

The gain reduction meter on the hardware and in the On-Screen Display displays the amount of gain reduction taking place.

### Attack

The **Attack** setting determines how quickly the compressor will respond to a sound’s level exceeding the threshold. A fast attack means the compressor will respond rapidly, and quickly turn down the sound when it has exceeded the threshold level. A slow attack means that the compressor will respond slowly. Such a setting leaves a part of the sound that



Compressor section on the Console 1 hardware.



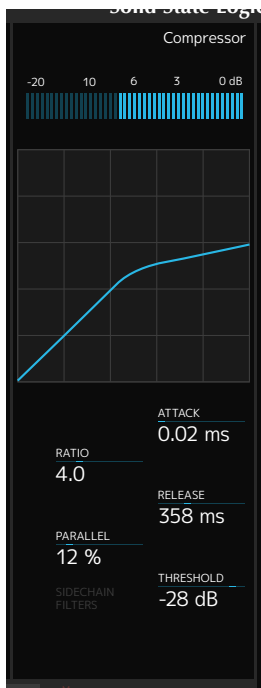

Compressor section on the On-Screen Display.

exceeded the threshold at its original level before the compressor reacts and turns down the output.

## Release

The **Release** setting determines how quickly the compressor will return to its normal gain after having reduced it. A fast release may give a more obviously compressed sound, while a slow release may sound more natural, and not be as clearly perceived as being compressed.

## Parallel Dry/Wet

**Parallel Dry/Wet** lets you blend the compressed and uncompressed signal

with a single knob. When this is turned fully counterclockwise (which is the default state), you only hear the compressed signal. By turning it clockwise, you gradually mix in the uncompressed sound. The percentage expressed in the On-Screen Display indicates the portion of uncompressed sound. One common use of the **Parallel Dry/Wet** function is to compress the sound heavily with a fast attack, and then blend in some of the original (uncompressed) signal. When set carefully, this may yield a nice balance between a sound that has a nice presence in the mix, but still sounds alive and dynamic.

## Filtering the Compressor Sidechain

As mentioned in “Filters to Compressor” on page

27, you can route the **High** and **Low Cut** filters to the compressor’s sidechain instead of applying them directly on the signal (by turning on **Filters to Compressor**). This is useful in a number of cases. It is for example a common trick to cut low end frequencies out of the compressor’s sidechain signal. Low frequencies often have a lot of energy and can cause the compressor to react stronger than one might find pleasing.

## Bass Drum Compressor Filtering

For example, a bass drum can cause a compressor across the drum bus to make the cymbals “duck” with every bass drum hit. Applying **Low Cut** to the compressor sidechain would make the compressor “deaf” to the lower frequencies of the kick drum, and it would consequently not respond as strongly to them.

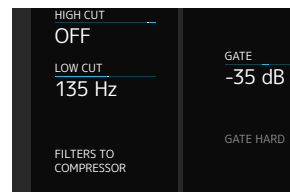
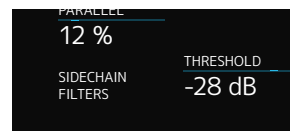

## De-essing Example

You can also use both **High** and **Low Cut** filters across the compressor sidechain to create a tight frequency window, which will be all the compressor responds to. Most de-essers work this way, by narrowing down the frequency of the compressor’s sidechain so it only detects and responds to the s-sounds. This could also work to reduce hi-hat bleed in a snare drum microphone. When this setting is active, the LED next to the **Filters to Compressor** button will light up, and it will also be indicated in the On-Screen Display.

Activating **Filters to Compressor** lights up the Sidechain Filters indicator in the Compressor section (top) and the Filters to Compressor indicator in the Input section (bottom).

## The Output section

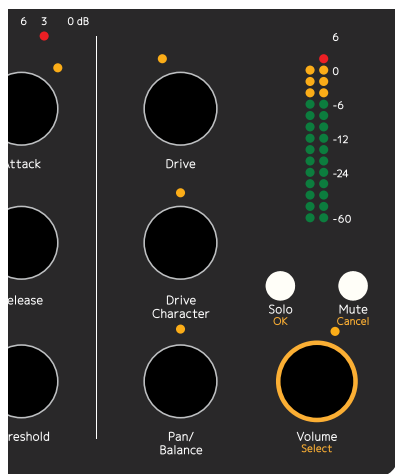

Output section on the Console 1 hardware.

### Drive

The **Drive** function enables the harmonics from the original consoles, in the default case the famous non-linear characteristics of the SSL SL4000E console. In many cases, the harmonics are what glues a mix together and creates that big, analog, console sound.

If applied subtly, you'll get the harmonics, warmth and character of the original console. Turn it up more and you'll get a more aggressive sound with mid-rangy harmonics and shaved-off transients. Turn it up fully and you'll get lots of fuzz...

The Drive section is entirely bypassed when the **Drive** knob is turned fully counterclockwise, so this corresponds to running your channel with a lot of headroom and no meters reaching the red.

### Gain Staging with the Drive Control

The idea behind the **Drive** is to give you the pos-

sibility to control how the console emulation is distorting, or in other words: *to control the headroom of the console.* With **Drive** is set a **OFF**, you will get no harmonics at all, and this part of the console emulation has been entirely bypassed. If you start to turn it up, and keep your levels below 0 dB (with **Output Volume** at 0 dB), you will get increased harmonics up until 5 (12 o'clock), where levels above 0 dB will start to distort. With **Drive** at 10, levels above -24 will start to distort.

If you set Drive at 5, you will get a behavior that corresponds to the real console.

### Drive Character

The **Drive Character** setting alters the character of the distortion. When set to its center position, the character is neutral and perfectly mimics the overdrive response of the analog unit that was modeled—the included Solid State Logic SL4000E or another Console 1 channel strip you have purchased separately. When turned clockwise, the harmonics in the high midrange are emphasized, which can often be useful to bring a sound forward in the mix. When turned counterclockwise, the midrange instead cleans up, leaving you with a sound that is saturated, thickened and softened, but not obvi-

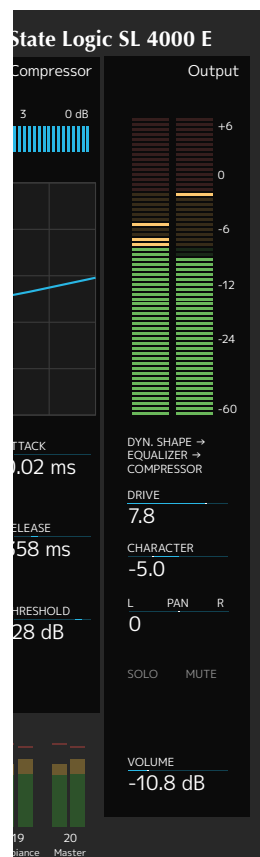

Output section on the On-Screen Display.

ously distorted. This is often useful to add a bit of sonic “glue” to complex sources, such as a bus with a whole instrument section or across the master bus.

## Pan/Balance

The **Pan/Balance** setting determines the relative level of the sound source in the left and right channels. Please note that the **Pan/Balance** setting does not affect your DAW’s pan setting. In order for the Console 1 **Pan/Balance** setting to work as expected, even mono tracks must be made stereo in your DAW (or “Mono to Stereo” where applicable.) This is because panning in Console 1 only works within the framework of the DAW channel. If you do not make mono tracks into stereo in your DAW, the DAW’s own pan knob must be used for panning.

## Solo

---

The easiest way to unsolo several tracks is to use the **All** feature. Just press **All + Solo** to toggle **Solo** on all tracks.

---

The **Solo** function sets the selected track in **Solo** mode. This means that all other tracks are silenced, with the exception of channels that have been set to **Solo Safe** in the Console 1 plug-in.

For more information on this, please refer to “Solo Safe” on page 13 and “Understanding Solo Safe” on page 35.

---

Please note that the Solo button only affects the Console 1 system, and not the solo function of your DAW. In order for Console 1’s Solo to function as expected, all tracks of the DAW mix must be routed to the Console 1 system. Tracks that are not routed to the Console 1 system will not be silenced when the Console 1 Solo mode is engaged.

---

You can easily see if a track has been soloed (and by

doing so, muting other tracks) since the Mute LED on the Console 1 hardware will flash on the muted tracks, as well as a flashing gray “M” indicator on the On-Screen Display and flashing Track Selectors for the muted tracks.

## Mute

The **Mute** function silences the selected track. When **Shift** is pressed and held, the **Mute** button works as a “Cancel” button and cancels your choice in a currently open menu. Just as noted above regarding the **Solo** function, the **Mute** function does not control your DAW’s mute function, it mutes the track internally within Console 1.

## Volume/Select

The **Volume/Select** setting determines the output volume of the selected track. The output volume is shown in the output section meter.

---

It is good practice to set this so peaks are below –6 dB and avoid peaks above 0 dB. Although the only channel where this really is important is the master bus—you should never exceed 0 dB on the master bus.

---

## Understanding Solo Safe

Setting aux channels and buses in **SOLO SAFE** mode means that when you select a single track and press **Solo**, the buses will still be open and let sound through. If you had inserted the Console 1 plug-in on for example the master bus (to which all tracks are summed in your DAW), and then soloed one of the single tracks, this would silence all other Console 1 tracks, including the master bus. Since all tracks pass through the master bus, and this gets silenced when you set a channel to **SOLO**, there would be no sound at all. But setting the master bus in **SOLO SAFE** mode means it will be excluded from

the tracks that are being silenced. If you do this and solo a single track, the master bus will keep open and you will hear the soloed track play.

---

Play it safe by setting all your buses, auxes, groups and the master track in **Solo Safe**.

---

The same logic applies to all buses/subgroups. So if you for example have routed all the drum tracks to a single stereo drum bus, and you have a Console 1 plug-in on that bus, make sure to set this in SOLO SAFE mode too. If you then for example solo the snare drum channel, it will play through the drum bus, and then through the master bus, and both of these will be left open if set to SOLO SAFE. If either of those are not set to SOLO SAFE, they would be silenced when you soloed the snare track, and you would get no sound at all.

It may also be a good idea to SOLO SAFE a Console 1 instance on an effects send channel, where you for example have a reverb or delay active. This way, setting a single track to SOLO will not silence the reverb. If the track you have soloed has an active send to the reverb (set up in your DAW), and you have set the reverb's effects send channel to SOLO SAFE, you will hear both the dry signal and the reverb's response to that signal. If you have not set the reverb's effects send channel to SOLO SAFE, you will only hear the dry signal from the soloed track and no reverb.

**Solo Safe** can of course also be used for single tracks that you want to be heard at all times, for example a metronome track.



# 4

## Useful Functions

We have now gone through the essential functions of Console 1. But there are even more useful functions to make your every day music mixing life even easier.

### Select All Tracks

By holding **All**, you select all tracks at once. Any adjustment you perform while holding this affects all tracks simultaneously. When holding **All**, a dialog window will appear in the On-Screen Display, informing you that all adjustments you perform currently affect all tracks.

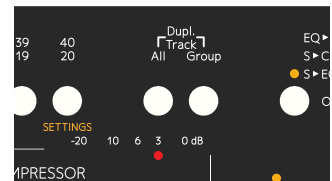

Press **All** to select all tracks at once, or **Group** to create temporary groups.

When using **All** or **Group**, only the parameters you change will affect the grouped tracks. The rest will remain unchanged.

### Create a Group

You can also create temporary groups of tracks that you want to adjust simultaneously, for example all background vocal tracks. In order to do this, first select one track that you would like to be part of the group with the corresponding **Track Selector** button. Hold **Group** on the hardware, and then press the **Track Selector** buttons of the other tracks that you would like to group with the first one. A message window in the On-Screen Display will inform you of what channels you are

#### GROUP TRACKS

Select which tracks to group with track 1.

To exit, just release group.

A message window in the On-Screen Display displays the current action.

grouping. Release the buttons, and perform the adjustments you would like. Press **Group** again, or select another track, to dissolve the group.

Please note that selecting all or creating a group works similarly to a VCA group on a traditional mixer. This means that a Console 1 track group is not a bus to which all the tracks are routed and summed together into a single stereo channel. It is merely a function to simultaneously adjust parameters of several individual tracks at once.

When selecting **All** or creating a **Group**, changes made to **Input Gain**, **Output Volume**, **Drive**, **Drive Character**, **High Cut**, **Low Cut** and **Pan/Balance** will be performed *relative to each channel's setting*. So if you for example select all and turn down the **Output Volume**, the relative level balance between the tracks will be intact, they will all just be turned down in volume.

Conversely, when making changes to any other parameter, this will result in all the tracks getting the same setting as the currently selected one.

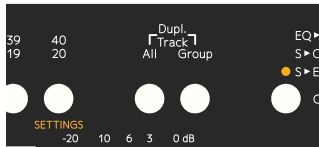

Duplicate tracks by pressing both **All** and **Group** at the same time.

Only knobs in the Input and Output sections changes relatively to each other in Group/All mode!

### A note on “relative knob changes”

Lets say you have grouped three tracks where all tracks have different **Output Volumes**, -10, 0 and +10 dB.

	Track 1	Track 2	Track 3
Volume	-10 dB	0 dB	+10 dB

If you select that group and increase the **Output Volume** with 10 dB, all tracks should get 10 dB louder. Except for Track 3, which will max out at +18 dB after an 8 dB increase.

	Track 1	Track 2	Track 3
Volume	0 dB	+10 dB	+18 dB

Keep on increasing the Output Volume until all tracks hit +18 dB.

	Track 1	Track 2	Track 3
Volume	+18 dB	+18 dB	+18 dB

Ok, that wasn't my plan, what happens now? Do I need to use the History function on each track to get back to my original setting? Nope. Just decrease the volume again. Console 1 remembers the relative changes. Let's just decrease the Output Volume on that group again, and we will get back to where we started.

	Track 1	Track 2	Track 3
Volume	+7 dB	+17 dB	+18 dB

...decrease another 17 dB:

	Track 1	Track 2	Track 3
Volume	-10 dB	0 dB	+10 dB

The relative knob changes only work while you are in Group/All mode.

## Duplicate Track Settings

You can duplicate track settings and copy them from one track to another—or several others. This can be either the entire channel strip setting, or just the Shape, EQ or Compressor settings.

1. Select the track you would like to copy from using the corresponding **Track Selector** button.
2. Press and hold both **All** and **Group** buttons. A dialog window in the On-Screen Display will inform you that you are about to copy the channel strip settings of the selected track, and prompts you to select the track to which you would like to copy these settings.

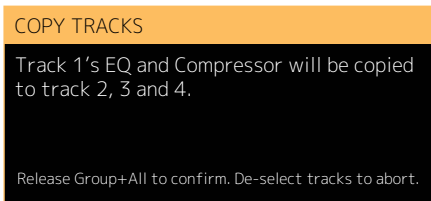

A message window in the On-Screen Display displays the current action.

3. Select the track (or tracks) you want to copy to by pressing the corresponding track selector button (or buttons), and release the **All** and **Group** buttons.

If you change your mind during this process, simply deselect the tracks you were copying to by pressing the track selector buttons again. When you now release the **All** and **Group** buttons, nothing will be copied.

## Duplicate Different Sections

In order to not copy the entire channel strip setting, but just the settings of single effects sections:

1. Press and hold both the **All** and **Group** buttons.

2. When the dialog window opens, press the on/off button next to the name of the section (or sections) you would like to copy—for example the **Equalizer Activate** button.

The dialog window now informs you that you are about to duplicate the equalizer settings of the selected track. You can select and duplicate any combination of Shape, Equalizer and Compressor to other tracks.

---

Only by duplicating the entire channel strip can you duplicate the High/Low Cut settings and the Drive settings.

---



# Load Presets

You can call up factory presets, as well as save your own ones. A preset can contain the entire channel strip, or one or several sections, so that you for instance can create an equalizer + compressor preset.



Access presets with the **Preset** button, or save your current settings by pressing **Shift + Preset**.

1. Press the **Preset/Save Preset** button to call up a list of entire channel strip presets. A dialog window will open in the On-Screen Display to show you a list of available presets for the channel strip you have loaded into the selected channel.
2. Select the category by using the **Output Volume/Select** knob:  
FACTORY CHANNEL STRIP: the entire strip  
FACTORY SHAPE: just the Shape section  
FACTORY EQUALIZER: just the EQ section  
FACTORY COMPRESSOR: just the compressor.  
PRESETS: presets saved by the user.

---

For example, loading an Equalizer preset will only overwrite the current equalizer's setting, and will not affect the rest of the channel.

---

3. Select the preset or folder by using the **Output Volume/Select** knob and navigate until you find the desired preset.
4. Confirm your selection by pressing **Solo/OK** or cancel the preset selection by pressing **Mute/Cancel**.



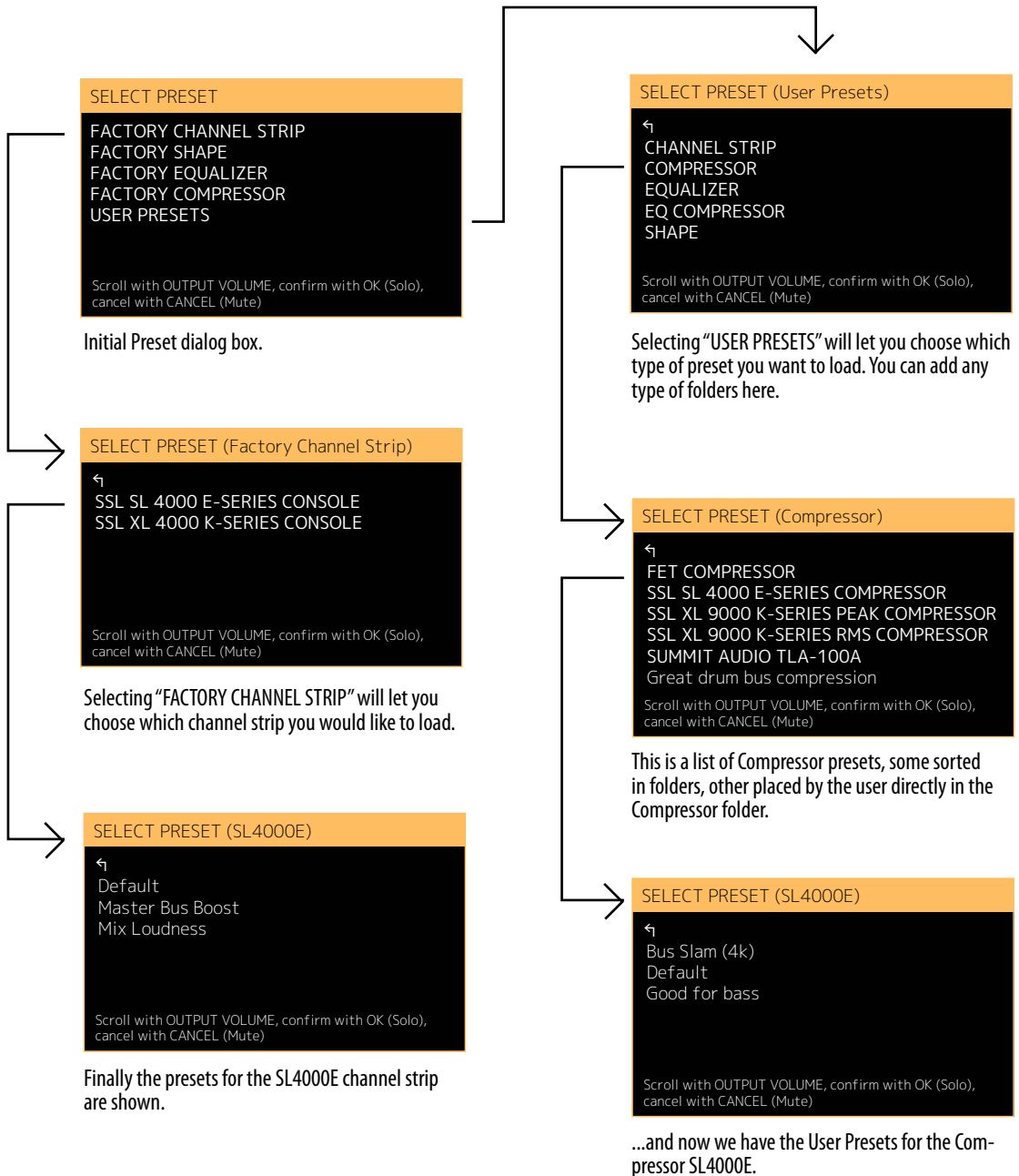

## Save Preset

Presets are by default saved into folders corresponding to the type of preset you want to save. For example, if you want to save the current settings on the SL 4000 E compressor as a preset, this will be by default be placed in the folder `Compressor/SSL SL 4000 E-Series Compressor/`. But you can organize presets in any way that suits you—see the next section for more.

To save your current setting as a preset:

1. • Hold **Shift** and press **Preset/Save Preset**.
2. • If you want to save the entire channel strip as a preset, just press **Solo/OK**.
3. • If you want to save just one or several sections, select those with the corresponding on/off buttons. Press **Solo/OK** when done.

---

It's easy to create a, say, EQ + Compressor preset: just select the EQ and Compressor after pressing Save Preset. Loading such preset will only overwrite the current EQ and Compressor, nothing else!

---

4. You will be prompted to name your new preset and save it. It will now appear in the list of available `USER PRESETS` if you call one up, as outlined above.

---

When saving a preset Console 1 will open a separate file browser window and close the On-Screen Display. Click on **Display On** to see the On-Screen Display again.

---

## Organizing your presets

As previously mentioned, presets are automatically saved in folders corresponding to the type (Channel Strip, Compressor, EQ, etc) and model (SL 4000 E, Tube-Tech CL 1B, etc). But you can create new preset folders and organize your presets in any way that suits you and your workflow.

---

Perhaps you'd like to create a new folder where you save all presets used in a particular project. Or you could sort presets by genre—so you'd have all your rock presets in one folder and jazz presets in another.

---

There are only two restrictions when it comes to organizing presets:

- User presets must be placed within the User Presets root folder.
- Default presets must be placed in the location the systems suggests. Read more in “Default Presets” on page 43.

## User Presets “Root” Folders

Here are the paths to where the user presets are stored:

Mac OS X: `/Users/$USERNAME/Library/Application Support/Softube/Console 1/Presets`

Windows: `C:\Users\$USERNAME\AppData\Roaming\Softube\Console 1\Presets`

---

By selecting the Shape, EQ and Compressor sections when saving a preset, you'll get a preset without the Input and Output sections. This is handy if you want to have a channel preset without changing the volumes or pan settings.

---

## Default Presets

Default presets are preset settings that are automatically loaded when you load an entire Strip or a plug-in into the Shape, EQ or Compressor sections of Console 1. The user can create default presets, which then override the factory default presets.

1. Hold **Shift** and press **Preset/Save Preset**.
2. If you want to create a default preset for the entire channel strip, press **Solo/OK**. If you want to create a default preset for a single plug-in or section, select that section with its On/Off button, and then press **Solo/OK**.
3. When prompted to save the file, name it `Default.c1preset` and save it in the suggested folder. Do not save it in at another location than the suggested folder, as it will then not be found by the system.

### Example

The default preset for the entire XL9000K channel strip should be called `Default.c1preset` and be saved in the `Presets/Channel Strip/SSL XL 9000 K-Series Console/` folder.

### Example

A default preset for the Tube-Tech CL 1B should be saved here: `Presets/Compressor/Tube-Tech CL 1B/Default.c1preset`.

---

You can for example create a default preset for the SL4000E but with, say, the Tube-Tech CL 1B compressor instead of the SL 4000 E.

---

## History

Most of today's DAWs have an unlimited undo function, so whatever mistakes you may have made can be undone. But this does most often not apply to plug-in settings. If you have gotten lost while adjusting a plug-in setting, you can usually not go back to a previous setting, unless you revert to a previously saved version of your project.

But Console 1 has an unlimited undo function for its settings, that we call *History*.

1. Hold **Shift** and press the track selector for track 5, with the orange text **History**.
2. Use the **Volume/Select** knob to scroll back (counterclockwise) and forward (clockwise) in time, and you will see the different parameters become highlighted and their parameters change back to their state before the adjustment was made.
3. When you have reached the point from which you would like to start over, stop scrolling and press **Solo/OK** (or **Mute/Cancel** if you prefer that.)

All actions and adjustments you made later than this point (the ones you just scrolled through) will be undone.

...and if you want to undo the recently undone, just enter *History* again and go back just one step.

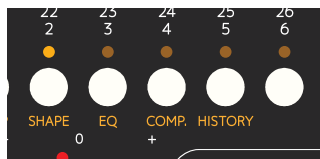

Access history by pressing **Shift** and track selector 5 (**History**)

## Settings

To access the Settings menu, hold **Shift** and press the track selector for track 20, with the orange text **Settings**.

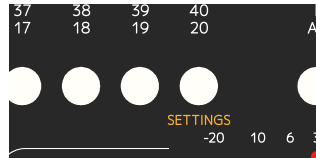

Access settings by pressing **Shift** and track selector 20 (**Settings**)

The Settings dialog contains the following options:

- AUTO SOLO TRACK ON RENAME/REARRANGE: ON (PAGE 45)
- RENAME TRACKS... (PAGE 45)
- REARRANGE TRACKS... (PAGE 45)
- ABOUT...
- SET AUTO DISPLAY DELAY (PAGE 46)

For information about these options, see the corresponding chapters.

## Renaming/Rearranging Tracks

As mentioned in “Setting Up Your First Console 1 Session” on page 9, some DAW hosts do not support automatic transfer of track name and number. Some hosts, such as Pro Tools and Logic Pro, only support automatic transfer of track name but not track number. In these cases, the user can manually set the correct name to the Console 1 tracks, and place them on the preferred track position.

Activate “Auto solo track on rename/rearrange” and start playback before you start renaming tracks. This will speed up the process and help you avoid making mistakes.

### Rename Tracks

Turn on “Auto solo track on rename/rearrange” and start playback, before you start to rename tracks. It will help you to avoid making mistakes.

1. Hold **Shift** and press **Track Selector 20/Settings**.
2. Use the **Volume/Select** knob to scroll down to **RENAME TRACKS**. Press **Solo/OK** to select this option.
3. Select the track you want to rename using the corresponding **Track Selector** button.
4. Enter the track name you would like in the box in the On-Screen Display and press **OK**.
5. Select another track to rename or press **Cancel/Mute** if you are done.

### Renumber/rearrange Tracks

In DAW hosts that do not support automatic trans-

fer of track number from the host to the Console 1 system, the track layout in the DAW does not automatically get reflected in Console 1. So if you work in such a DAW and for example would like to move track 25 so it's placed after track 12 in your DAW, a corresponding move does not occur in Console 1. If you wish to have a consistent track layout between the DAW and Console 1, you can follow these steps to manually rearrange the Console 1 tracks:

1. Hold **Shift** and press **Track Selector 20/Settings**.
2. Use the **Volume/Select** knob to scroll down to **REARRANGE TRACKS**. Press **Solo/OK** to select that option.
3. Select the track you want to move using the track selector buttons.
4. Select where you want to put it, by using the track selectors.

### Example

Say you have 7 tracks, A to G:

A	B	C	D	E	F	G		
---	---	---	---	---	---	---	--	--

You add an eighth track, which by default is placed on the lowest available position:

A	B	C	D	E	F	G	X	
---	---	---	---	---	---	---	---	--

If you move it to the 4th position, the other tracks will be moved upwards:

A	B	C	X	D	E	F	G	
---	---	---	---	---	---	---	---	--

## Auto Solo Track on Rename/Rearrange

Set this to **ON** if you want to solo the track that's currently being renamed or moved. This is very useful if you insert Console 1 on all tracks on an

existing session and quickly want to name all tracks. Just hit play, start with track 1 and listen what's on it, and proceed through all tracks the same way. Easy peasy!

## Set Auto Display Delay

This option sets the time it takes for the On-Screen Display to turn off if you are in “Auto” mode (**Auto** button lit). Default is 4 seconds.

### Set Auto Display

**Delay** 0.2 s, 1, 2, 4, 6, 10 30 seconds, 1 min, 5 min.

## FFT

In the FFT menu you can set if FFT should be calculated at the input or the output, set block size and FFT decay time. For more information, see “View Options” on page 52

### Processing (Input/ Output)

Selects if the analyzer should analyze the input or the output signal.

**Block Size** Sets the block size of the FFT calculations (1024, 2048, and 4096 samples). With a larger block size you will get a more detailed analyzer, but it will update less often. A short block size gives you a fast, but less detailed analyzer.

**Decay** Set the decay of the analyzer (10 or 30 dB/s). With a fast decay (30 dB/s) it is easier to

see transients, like snare hits, but harder to see the general frequency response.

## Alerts

Specify if you want to be alerted about compatibility changes in your DAW and/or Console 1.

**Alert DAW Features** Set to **ON CHANGE** to always get notified, or **NEVER** if you don't want to be alerted.

We recommend you to set it to **ON CHANGE**, but if you are switching DAWs a lot and want to get rid of the notification, set it to **NEVER**.

## Using Console 1 Without the Hardware

Many of today's musicians and mix engineers work with portable lap top computers, and use them in many different locations. While the Console 1 hardware is not too big or heavy to bring with you, you may not have it available at all times. For this reason, we made it possible to adjust Console 1's settings using the computer mouse.

In your DAW, open the Console 1 plug-in on the track you would like to adjust. Click **Show Knobs**, and an interface that resembles the Console 1 hardware will appear. This is fully clickable with the mouse, and you can adjust Console 1's settings from here.

## Automation

All Console 1's parameters can be automated into your DAW. Automation can either be programmed,

just like any plug-in in your DAW, or by using the Console 1 hardware to write the automation in real time. Please refer to your DAW's manual for further information on how this is done.

## Automation in Pro Tools

Since the Console 1 controls aren't touch sensitive, automation is preferably made in Latch or Write instead of Touch mode.







Gareth Jones's Studio, UK

# 5

## Customizing the Channel Strip

Even though the basic functions of Console 1 as well as the included model of a Solid State Logic SL4000E should be more than adequate for any mixing tasks, there are ways of customizing the channel further. We go through these here.

### **Loading Other Channel Strips and Effects**

The included Solid State Logic SL4000E is an excellent channel strip, but sometimes one might like to have the option of other sound characters. Either just another compressor or equalizer, or a whole other channel strip sound. Softube will continuously release new models of analog hardware in the form of channel strips that will perfectly integrate with the Console 1 system. These will be separately available for purchase. But you can also use all the other Softube plug-in equalizers, compressors and gates as part of a Console 1 channel.

Note that plug-in effects you load into the Console 1 system may not perfectly correspond to the screen printed parameters on the Console 1 hardware. Some Console 1 knobs may change or lose their function, and there may be plug-ins that have more functions than can be controlled from within Console 1. This will however all be reflected in the On-Screen Display. If you find you would like to use a function that can not be reached through the Console 1 system, we recommend that you simply launch the ordinary plug-in version in your DAW and control its settings with your mouse, just as you would have done before you got the Console 1.

## Load Plug-Ins

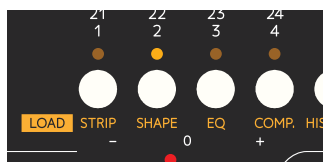

Load different strips and plug-ins by pressing **Shift** and select either **Strip**, **Shape**, **EQ** or **Comp**.

Loading Console 1 compatible channel strips and effects is done by holding **Shift** and pushing one of the first four channel selector buttons, with the orange labels

### Strip, Shape, EQ and Comp.

Holding **Shift** and selecting **Strip** (track selector button 1) lets you load any Console 1 channel strip into the selected track, replacing the Solid State Logic SL4000E.

Doing so opens a menu where you see all Console 1 compatible channel strips that you have available on your system. Scroll down the list using **Volume/Select**, and press either **Solo/OK** to confirm or **Mute/Cancel** to cancel. The channel strip name and logo in the On-Screen Display will change to reflect your choice.

In a similar manner, you can choose to load single effects into the Shape, Equalizer and Compressor sections separately. Again, hold **Shift** and press track selector button 2 to load a Shape effect, track selector button 3 to load an equalizer or track selector button 4 to load a compressor. Again, a menu will appear, listing the compatible and suitable effects. Use **Volume/Select** to scroll down to the effect you would like to use, and press either **Solo/OK** to confirm, or **Mute/Cancel** to cancel.

If you load a Shape, Equalizer and/or Compressor effect, the **High Cut** and **Low Cut** filters and the **Drive** section will not change from what was included in the channel strip you are customizing. These sections only change with the channel strips.

You can also create default presets for different strips or plug-ins by saving a preset called `default.c1preset` in the corresponding folder. See “Save Preset” on page 42.

## Changing the Order of the Sections

The default order of the Console 1 effects is as they are laid out on the hardware and in the On-Screen Display: first shape, then equalizer and finally compressor.

Sometimes a different order of the effects may be desirable. For example, if you add a lot of low frequencies with the equalizer, it may be better to do this after the compressor.

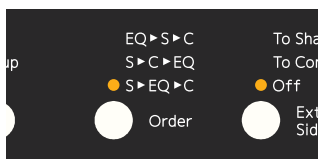

Change the order of Console 1's sections using the **Order** button.

The current order is displayed above the **Order** button and in the On-Screen Display. The default state is  $s \rightarrow EQ \rightarrow c$  (shape, equalizer, compressor). To change the order of the effects sections, press the **Order** button. The other options are  $EQ \rightarrow s \rightarrow c$  (equalizer, shape, compressor) and  $s \rightarrow c \rightarrow EQ$  (shape, compressor, equalizer).

## Using External Sidechain Signals

It is a common trick to feed an external signal into

the sidechain of a compressor or a gate. Doing so means that the compressor or gate will no longer act in response to the sound signal it affects, but to the external signal which is being fed into the sidechain.

## A Keying Example

An example of using the external sidechain for a gate: let's assume the gate is inserted on a track with a synth pad. The synth pad plays continuously, with no interruption. But instead, we would like it to follow the pattern of the kick drum, and have the pad appear at every kick drum hit and disappear in between. To do this, you would insert the gate on the pad track. You would then route the kick drum sound into the sidechain of that gate. Now, every time the kick drum hits, the gate will open and let the pad sound through. But in between kick drum hits, the gate will close and silence the pad track.

## A Ducking Example

Used with the same signals, but on the compressor: The compressor is inserted across the synth pad signal, and the kick drum is routed to the compressor sidechain. Now, every time the kick drum hits, the compressor will react and turn down the output signal of the pad. So the pad will be its normal volume in between kick drum hits, but lower every time the kick drum hits. This is often called ducking, the pad ducks every time the kick drum hits.

## Doing it with Console 1

To get this set up in Console 1, you go to the DAW channel where you have the sound source you would like to be affected by the sidechain (in the examples above, that would be the DAW channel where the pad synth is). Open the Console 1 plug-in window, and set it up to have its sidechain fed with the signal you would like to affect it (in our example,

that would be the kick drum). Refer to your DAW manual for the details of setting up an external sidechain.



Select whether an external sidechain (if applicable) should be sent to the compressor or shape section.

Once this is in place, you can go back to the Console 1 system. With the **External Sidechain** button, you can select if you would like the external sidechain signal to be routed to your gate or to your compressor, or not have any effect at all. When set to **OFF**, the sidechain signal does not affect neither the gate nor the compressor. When set to **TO SHAPE**, the external signal gets routed to the Console 1 gate's sidechain. When set to **TO COMP**, the external signal gets routed to the Console 1 compressor's sidechain.

## View Options

If you would like, you also have a few options when it comes to the appearance of the On-Screen Display. Hold **Shift** and press **Display On/View**. This will toggle through the different views available.

### Frequency Analyzer (default)

The default mode shows the frequency analyzer. To change settings of the frequency analyzer please enter the **SETTINGS** menu (hold **Shift** and press **20/Settings**) and select **FFT**. All these options are global and applies to all tracks.

#### Processing (Input/

Output) Selects if the analyzer should analyze the input or the output signal.

**Block Size** Sets the block size of the FFT calculations (1024, 2048, and 4096 samples). With a larger block size you will get a more detailed analyzer, but it will update less often. A short block size gives you a fast, but less detailed analyzer.

**Decay** Set the decay of the analyzer (10 or 30 dB/s). With a fast decay (30 dB/s) it is easier to see transients, like snare hits, but harder to see the general frequency response.

### No Frequency Analyzer

This mode is the same as the default view mode, except that the frequency analyzer has been turned off.

## Knobs View

Instead of showing equalizer and dynamics graphs, this mode shows a visual representation of the knobs of the hardware.

### Large and Small Meter Bridge

If you want to use the Console 1 without the OSD, it might be useful to have a small scribble strip/meter bridge showing at the bottom of your computer screen. The two meter bridge modes are made for that purpose.

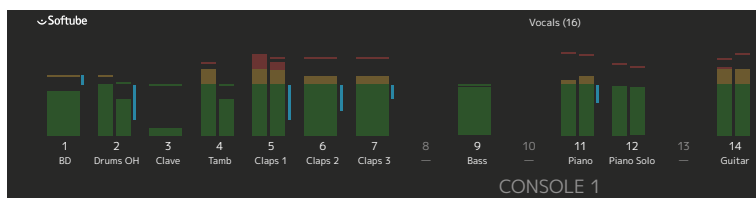

The large meter bridge view.

The large meter bridge shows 20 tracks, with output and dynamics meters, as well as solo/mute and track name and number.

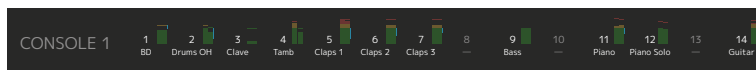

Small meter bridge view.

The small meter bridge has the same information, but the meters are very small. This mode is mainly intended to use as a virtual scribble strip.

Both the large and the small meter bridge views can also be accessed by simply resizing the On-Screen Display so that it becomes short and wide.



# 6

## DAW Integration

Console 1 is on its own a very powerful mixing tool, but it becomes even more versatile with the integration that many DAWs supply. In general, integration is only available for VST3, AU and AAX, and not in VST 2 format. For DAW integration to work properly, you should always use the latest version of your DAW and Console 1.

### Track Number

With automatic track numbering, the track number in Console 1 will always be in sync with the track number in your DAWs mixer. Move a track in your mixer, and it will get moved in Console 1. Different DAWs will handle aux, effects and master tracks differently.

The **TRACK NUMBER** feature is currently available in **Presonus Studio One**, **Cubase**, **Nuendo**, **Logic Pro X**, **Cakewalk SONAR** and **Ableton Live** (AU only, requires that all track names begin with a “#”, note the blank space)

---

For an updated list of supported hosts, please see our web site.

---

## Track Name

With automatic track names, the name you set on your track in your DAW gets automatically transferred to Console 1. This feature is available in all hosts that supports `TRACK NUMBER`, with the addition of Pro Tools, that only supports `TRACK NAME`.

## Integrated DAW Control

With the integrated DAW Control you are able to control the DAW's **Fader Volume, Pan, Solo, Mute** and **Send Levels** directly from your Console 1 hardware. Select a track in your DAW and the same track will get selected in Console 1, change the **Output Volume** in Console 1, and the corresponding track's fader will move.

Integrated DAW Control is currently available in the latest versions of **Presonus Studio One** and **Cakewalk SONAR**.

## Volume, Solo and Mute

DAW CONTROL is automatically turned on for DAWs that support it. With DAW CONTROL enabled, the **Output Volume, Pan, Solo** and **Mute** will automatically control the corresponding functions in your DAW.

If you press `SHIFT` on your Console 1, you will be able to control Console 1's internal **Output Volume** instead of the DAW's functions. This can be useful if you want to overdrive the output section in Console 1, or want to set basic levels with Console 1, and use the DAWs faders for automation and level riding.

Console 1's internal **Solo** and **Mute** will get disabled, and the hardware's **Solo** and **Mute** buttons will now control the **Solo** and **Mute** in the DAW.

## Meter Levels

When DAW CONTROL is activated, the output meters will display the levels after the DAW's fader and pan has been applied. This level is approximated, and if you have processing between the Console 1 and the DAW's fader, the metering can be incorrect.

If you want to see the output levels coming out of Console 1, without the DAW's volume and pan, press `SHIFT`.

## Controlling Send Levels

You can access the track's three first sends by pressing `SHIFT` and adjusting the **Drive, Drive Character** and **Pan/Balance** knobs.

When you click `SHIFT` you will see on the On-Screen Display that the knobs change function.

## DAW Track Selection

DAW TRACK SELECTION lets you select a track in Console 1 by selecting it in your DAW, or vice versa.

---

Please note that whenever the DAW Control is enabled, Console 1's internal **Solo, Mute** and **Solo Safe** functionality gets disabled. A saved session that is using **Solo** and **Mute** and is opened with DAW Control will turn off and disable the internal **Solo** and **Mute** and let Console 1 control the DAW's **Solo** and **Mute**. You can always go back by disabling DAW Control from the Setup menu in the plug-in.

---



# Disabling DAW Integration

It is possible to turn off the DAW integration features, even if we don't recommend it. Not all of these features are available in all DAWs.

You do this by clicking **Setup** in the plug-in window (not in the On-Screen Display!) These settings are global and will affect all instances of the plug-in in all DAWs.

**Use DAW Control** This feature turns on the Integrated DAW Control, with Console 1 control over the DAW's fader volume, pan, solo, mute and sends.

**Use DAW Track Selection** Let Console 1 select the track in the DAWs mixer, and vice versa.

**Use DAW Track Name** Fetch the track name from the DAW

**Use DAW Track Number** Fetch the track number from the DAW.

---

If you are working with DAW project templates and always want your sessions to look the same in Console 1 it can be helpful to turn off "Use DAW Track Number"

---





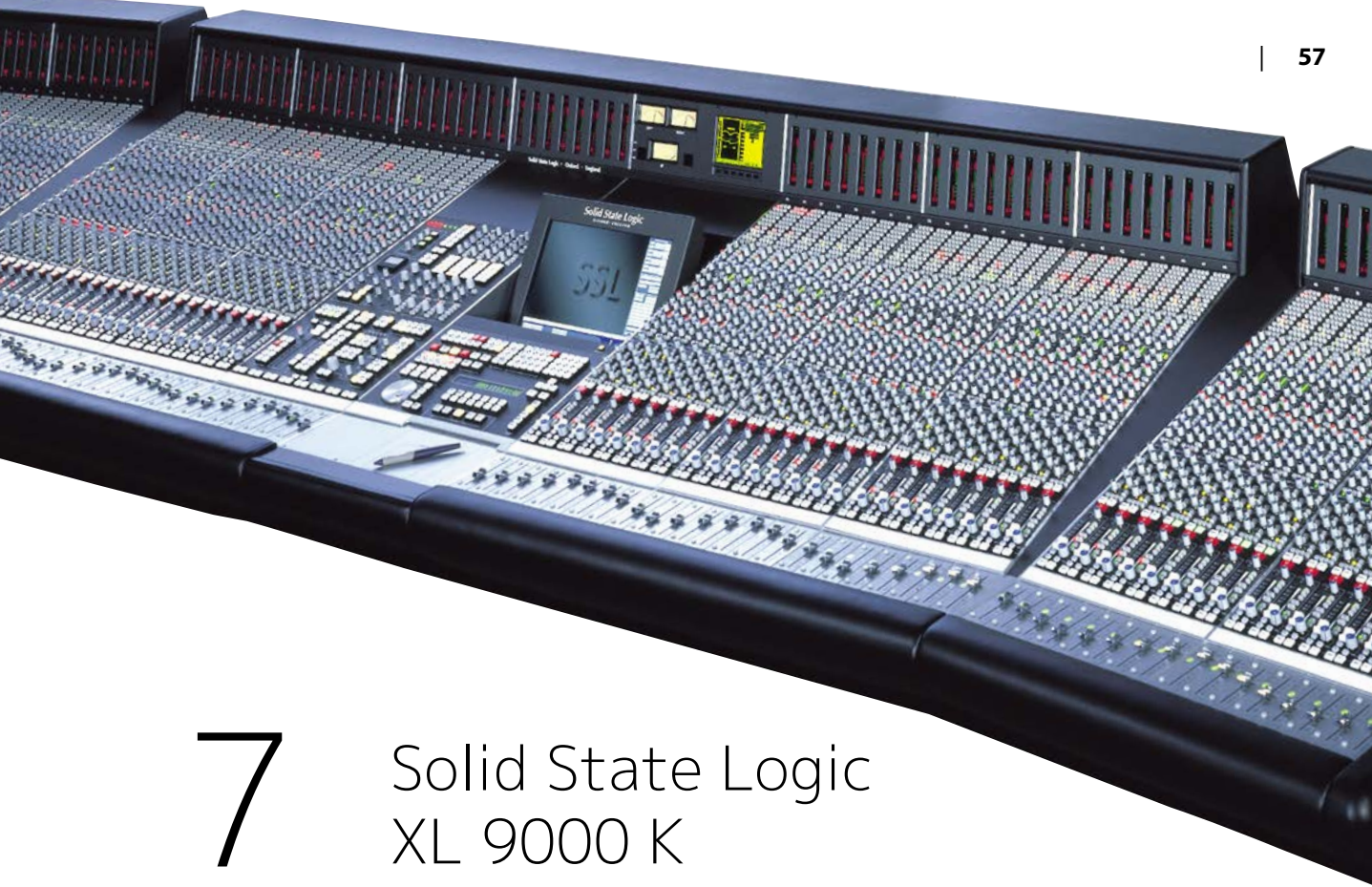

# 7 Solid State Logic XL 9000 K

In order to expand the sonic options of Console 1, Softube offers other console emulations to be purchased separately, in addition to the included SL 4000 E model. The first such additional console model is Solid State Logic XL 9000 K. This can be purchased in Softube's web store ([www.softube.com/buy](http://www.softube.com/buy)) or at any authorized Softube dealer.

Solid State Logic XL 9000 K represents a completely different approach to analog circuits compared to the SL 4000 E channel that is included with Console 1. And since the XL 9000 K, thanks to the amazing Super Analogue technology, has virtually no distortion of its own, the Softube channel also includes a model of SSL's famous VHD (Variable Harmonic Distortion) circuit.

While Solid State Logic's SL 4000 E is widely considered a great pop and rock'n'roll console with its slightly gritty and forward sound, the circuit design of XL 9000 K offers an extreme bandwidth, minimal phase shift and super low distortion. This makes it one of the world's most popular analog consoles for hip-hop and R'n'B, where the solid, deep low end and extended highs work great for getting that hyper modern, large and wide sound. For the same reasons, it is also loved for classical and acoustic audiophile recordings.

## VHD model included

XL 9000 K is a very clean console. In order to still have the option of using distortion creatively, we added a model of Solid State Logic's VHD (Variable Harmonic Distortion) circuit, which is part of the Duality series consoles and Alpha channel preamps. The Drive knob on Console 1 determines the amount of distortion, and the Character knob moves the added distortion from 2nd order (more tube-like) to 3rd order (more transistor-like), or any in-between blend—just like on its analog counterpart.

## Extended gate and compressor options

Furthermore, the Shape section of the XL 9000 K for Console 1 features a fully controllable gate unit,

where the Punch and Sustain knobs control Range and Hold levels. This makes it more individually adjustable compared to the SL 4000 E model, where a fast workflow was prioritized. The compressor comes in two flavors, one with the PEAK circuit (“Peak” button on the original console) and the other with the RMS circuit, which allows for a softer knee and sometimes a more musical compression.

## Select different compressor modes

You select between these two modes when you insert the compressor on a channel using LOAD COMPRESSOR (**Shift + Track Selector 4**) on the hardware. If the XL 9000 K strip is installed, you will see the two compressors: “SSL XL 9000 K-SERIES PEAK COMPRESSOR” and “SSL XL 9000 K-SERIES RMS COMPRESSOR”. Just select which one you'd like to use.

The control section of the XL 9000 K in Peter Gabriel's studio Real World UK.







XL 9000 K compressor section.



XL 9000 K equalizer section.

## Background

When the first 9000 series console came out in the mid-1990s, it represented a breakthrough in analog circuitry design. The sound path is entirely capacitor-free, in order to keep a perfect signal

integrity and low distortion. The XL 9000 K was the last and most developed version of the 9000 series, released in 2002. It is this version that forms the backbone of Peter Gabriel's Real World Studios, Wyclef Jean and Jerry Wonda's Platinum Sound, and Michael Brauer's room in Electric Lady Studios.

Solid State Logic XL 9000 K was introduced in 2002. Note that there's a Lexicon 960 remote sitting on top of the console, and the SL 4000 E photo had a Lexicon 244 remote. Time changes... Photo from Pacific Studios, USA.





The screenshot shows the Softube Console 1 interface for the British Class A module. The interface is divided into several sections:

- Input:** Features a level meter on the left and controls for High Cut (OFF), Low Cut (OFF), Filters to Compressor, Phase Invert, and Input Gain (0.0 dB).
- Dynamic Shape:** Includes a threshold meter (set to -41.5 dB), Recovery (5), and Depth (34 dB).
- Equalizer:** A frequency response graph with four frequency sliders: Low Type (SHELF), Low Mid Q (1), High Mid Q (1), and High Type (SHELF). Below the graph are controls for Low Frequency (60 Hz), Low Mid Freq (1.6 kHz), High Mid Freq (1.6 kHz), High Frequency (12), Low Gain (0.0 dB), Low Mid Gain (0.0 dB), High Mid Gain (0.0 dB), and High Gain (2.4 dB).
- Compressor:** Features a ratio meter (set to 2:1), Release (1.5 s), Parallel WET % (0%), Sidechain Filters, and Threshold (+3 dB).
- Output:** Includes a level meter on the right and controls for DYN\_SHAPE → EQUALIZER → COMPRESSOR, Drive (OFF), Character (0.0), L PAN R, Solo, Mute, and DAW Volume (0.0 dB).

At the bottom of the interface is a channel strip labeled "CONSOLE 1" with 20 channels: 1 MIXER, 2 Bass, 3 Drums, 4 Piano, 5 Damped Piano, 6 Wurly, 7 Electra, 8 Guitars, 9 Guitar (Bridge), 10 Hammond, 11 Hammond (Bridge), 12 Vocals, 13 Rev Voc, 14 Rev Amb, 15 Delay, 16, 17, 18, 19, and 20 Main.

# 8

## British Class A

In order to expand the sonic options of Console 1, Softube offers other console emulations to be purchased separately, in addition to the included SL 4000 E model. The British Class A, as well as Solid State Logic XL 9000 K can be purchased in Softube's web store ([www.softube.com/buy](http://www.softube.com/buy)) or at any authorized Softube dealer.

### Introduction

ADD BODY AND CHARACTER TO YOUR TRACKS with a Console 1 strip inspired by classic British units from the 60s and early 70s. Let your tracks soak in the fat transformer crunch of the input stage, get great tone with the honey-sweet equalizer, control dynamics with the beautifully musical compressor, smash them into oblivion with the limiter, and keep things tight and tidy with the super-responsive gate.

British Class A For Console 1 collects the most coveted and distinctive sounding units

of the pro audio world in a single channel, with a completely different character than the two SSL channels available. Read on for a walkthrough of the channel's sections.

## Drive

In the early 70s, it quickly became apparent to recording engineers that pushing the transformer coupled input stage of these consoles harder than it was really designed for added a rich sound to the recordings which made them large and alive sounding. The first and most coveted generation of the input channels incorporated Marinair transformers, and these are the ones we have emulated to get exactly the sound that has helped generations of sound engineers to achieve great mixes. Just turn up the **Drive** knob a bit on all your tracks. The Character knob does a similar thing as in the SSL SL 4000 E channel, turning it counterclockwise gives the distortion character less midrange emphasis (good for adding subtle density and warmth to tracks), turning it clockwise makes it more aggressive (good for making sounds stand out in the mix). In the 12 o'clock position, you get exactly the original sound of the original console input stage from the early 70s.

## Equalizer

To ensure the model's accuracy, the British Class A Equalizer has been based on several different original vintage hardware pieces. While staying true to the originals' character, curve shapes and even their odd little quirks, we have added dual mid bands for further flexibility—the originals only had a single one. So you can for example use one for the lower mids and one for the higher, something that was not possible on the analog originals unless you combined two individual channels. The four EQ bands all have an OFF position, which you'll find by turning the **Frequency** knob fully counterclockwise for

the **Low**, **Low Mid** and **High Mid** bands, and fully clockwise for the **High band**. You will note that with all the EQ bands set to OFF, the EQ curve displayed in the Console 1 On-Screen Display is not entirely flat. This reflects precisely how the original equalizers behave—they add a little something even when the bands are supposedly in bypass! Using the Equalizer button in the top left corner of Console 1's EQ section of course still takes the EQ entirely out of the signal chain.

## Compressor

The British Class A Compressor adds a full-bodied and syrupy tone to the sound source, in addition to its highly musical gain reduction. The model is based on the classic British diode bridge compressor/limiter, which first came out in 1968. As with the equalizer, we've added extra flexibility, incorporating a modification used by many top-level studios to improve control of attack times and add more release time options. We have also extended the Threshold range to make it useful for a wider variety of incoming signal levels.

The original compressor offered no control over attack times, it was fixed to circa 3 ms. The modification, and the British Class A Compressor model, adds 6, 12, 20 and 30 ms attack settings. Furthermore, the modification adds 100 and 200 ms to the release time (or **Recovery** as it's labeled on the original), in addition to the four options of the original: 400, 800, 1500 ms and AUTO. AUTO automatically adjusts the release time to fit the musical content, and you may find it particularly useful on complex and eventful material such as across the entire stereo mix or on a drum buss.

So to stick to the original hardware sound, keep **Attack** on 3 ms, and leave out 100 and 200 ms **Release**. You can save any setting as the default setting—please refer to the “Default Presets” on page 43.

## Limitter

The original compressor also incorporated a limiter section which we have modeled separately and added as a single plug-in for maximum usability.

The British Class A Limiter is great for subtle level control—or for beating your sounds into submission. By default, the British Class A Compressor is loaded into the channel, so you load the limiter by holding **Shift + Track Selector 4** (LOAD COMP).

Use the **Volume/Select** knob to scroll to British Class A Limiter, and press **Solo/OK** to confirm.

To shift back to the British Class A Compressor, go through the same process but this time select British Class A Compressor. No modifications have been made to the limiter's release times, these are just the same as on the analog hardware original.

## Gate

One of the lesser-known classic British units from this era, the original analog gate shared the same form factor as the equalizer and compressor units we've modelled. The gate does a terrific job of keeping tracks tighter and cleaner, and using the side-chain input makes it very useful for ultra-musical keying purposes. Compared to the included SSL SL 4000 E gate, you will note that the British Class A Gate has a slower and more sluggish behavior when it opens and closes. This means that transients of the sound will be rounded off and made softer.

Some slight changes have been made to the operation of the British Class A Gate compared to the SSL SL 4000 E gate. The **Gate** knob on the Console 1 hardware controls the British Class A Gate's *threshold* setting, **Gate Release** is called **Recovery** in the software and we have omitted the **Punch** and **Sustain** functionality and instead let the **Punch** knob control the British Class A Gate's **Depth** parameter.







# 9 Summit Audio Grand Channel

In order to expand the sonic options of Console 1, Softube offers other console emulations to be purchased separately, in addition to the included SL 4000 E model. The **Summit Audio Grand Channel** can be purchased in Softube's web store ([www.softube.com/buy](http://www.softube.com/buy)) or at any authorized Softube dealer. The Summit Audio Grand Channel works both as a regular plug-in and as a dedicated Console 1 channel strip.

For more in detail information regarding the Summit Audio Grand Channel, please see the **Summit Audio TLA-100A** and **EQF-100** chapters in the Softube Plug-ins Manual.

## The Tone Sculpter

WE KNEW FROM THE OUTSET of our development of the TLA-100A compressor that we wanted to create a beautiful looking, extremely versatile and gorgeous sound-

ing channel strip plug-in which would combine the TLA and the EQ beast known as the EQF-100. But the EQF-100 proved to be a more difficult creature than we had first imagined.

After having modeled plenty of equalizers we felt confident that absolutely nothing could surprise us and that we would keep all deadlines. We couldn't have been more wrong. The passive design of the EQF-100 was intricate, well-designed and just as beautiful as we thought it would be. We just didn't realize how complicated it was.

But after plenty of work developing a new technique for modeling of big passive circuits we feel confident that you will enjoy this monster.

## EQF-100 Full Range Equalizer

Four full bands of equalization and a warm output distortion makes this equalizer extremely versatile. It can be used on any type of source, and once you get to know it, it will become your best friend.

## TLA-100A Tube Leveling Amplifier

It doesn't have many knobs, but can create a vast amount of different sounds. With an opto-like compression circuit, you'll get a smooth compression with a very soft knee. But due to its modern and intricate design you can set it to be faster than any other opto-compressor, which makes it more versatile than its competitors.

## Different Kinds of Distortion

The TLA-100A plug-in has a separate saturation control which lets you adjust the headroom of the unit, so that you can go from a clean sound with almost no audible distortion at all, to a fully saturated leave-no-transients-intact sound. The distortion in the TLA is therefore well-suited for taming transients in drums, but maybe not the first choice when you need to warm up a vocal track.

The distortion of the EQF-100 has a totally different character, warm and fat, due to its strong 2nd order harmonic. It is very well suited for vocals, bass or brass.

As a Console 1 channel strip, we've made it even easier to dial in that perfect saturation. The **Drive** section consists of both types of distortion, and you can easily blend between these by adjusting the **Drive Character** knob. It goes from full TLA glory, to 100% EQF warmth.

## Shape

Since the Grand Channel doesn't have a shape or gate section, we decided to put the versatile and beautifully sounding Dynamic Shape from the Solid State Logic SL4000E as the default Shape unit.

## Input Filters

The input filters are modeled from the filters in the EQF-100, but modified to be continuous instead of stepped.





Format:C Studio, Erfurt, Germany

# 10 Specifications, Requirements and Troubleshooting

## Mac OS X specific requirements

- Mac OS X 10.8 or newer

## Windows specific requirements

- Windows 7 (latest Service Pack), Windows 8 or 10. 64-bit version.
- Intel Core Duo, AMD Athlon 64 X2 or newer processor

## General requirements

- Screen resolution 1280x800 or larger
- Any VST, VST3, AU, or AAX (Pro Tools 10.3.7, 11.0.2 or higher) compatible host application
- 1 powered USB 2.0 compatible port
- iLok License Manager (iLok USB key is NOT required)
- Broadband internet access for downloading software.

The Console 1 plug-in supports the following sample rates: 44.1, 48, 88.2, 96, 176.4 and 192 kHz. Console 1 is not available for AAX DSP.

## Block Diagram

The following schematic outlines the operation of Console 1. For the sake of simplicity, the different order of the sections (EQ before Shape before Compressor, etc) are not included. Neither are stereo/mono operation on dynamic's sidechains.

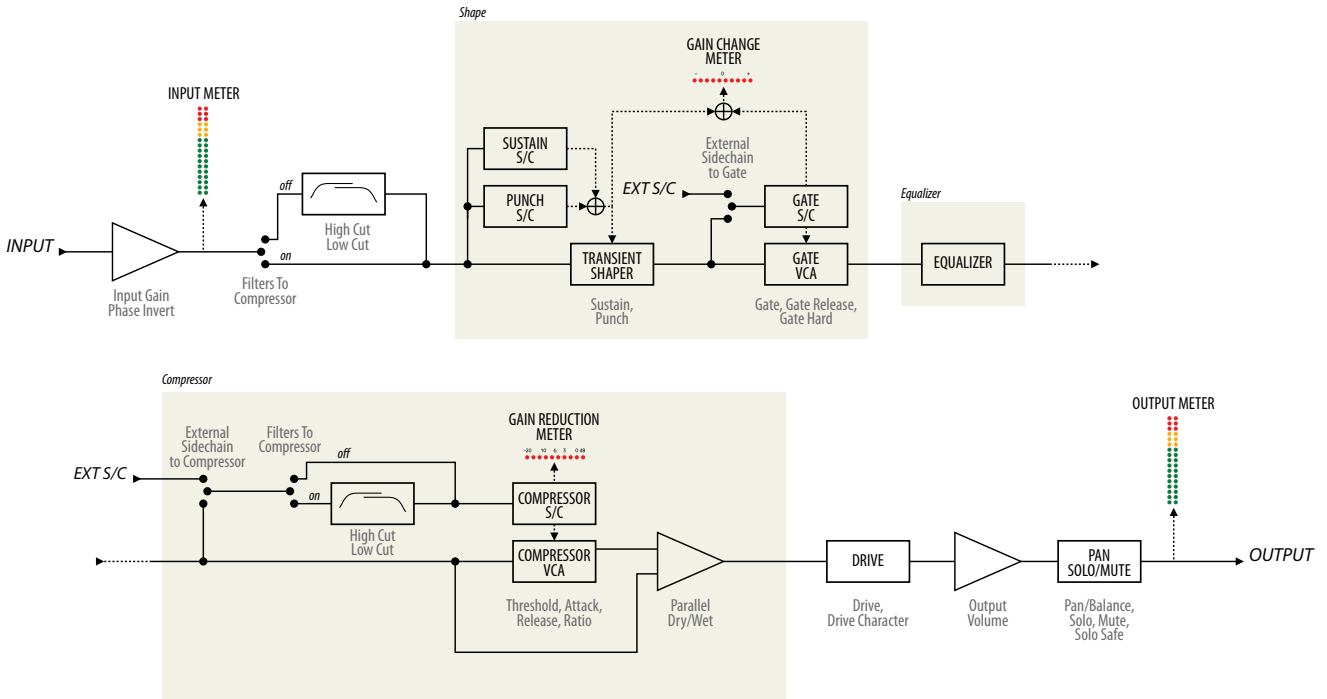

# Troubleshooting

## Hardware Does Not Turn On

If you're using a passive, non-powered, USB hub, the Console 1 may fail to power on because it is not getting enough power. Please connect the Console 1 to a powered USB hub, or directly to your computer.

Since Console 1 may require the full 500 mA it may interfere with other USB appliances on the same hub.

## Software Errors

Even if software errors should be few, you may sometimes experience an “Unknown Error”. This is not a problem, and usually just means that “while your computer did this, it didn't do that fast enough for me”. Anyway, if you do get an “Unknown Error”, **please make sure that you have the latest version of our software installed!** If you do, please try the following steps:

1. Unplug the Console 1 hardware
2. Plug it back in again

If that didn't help, do this:

3. Exit Console 1 On-Screen Display, unplug the Console 1 hardware and quit your DAW
4. Start Console 1 On-Screen Display
5. Plug in the Console 1 hardware
6. Start your DAW again

That should definitely do it. If not, try a reboot.

## Mac OS 10.8+ Firewall

The Console 1 application uses internal network

ports to communicate between plug-ins and the Console 1 application, which will trigger a firewall alert the first time the application is started. You need to click “ALLOW”, otherwise nothing will work.



You need to allow Console 1 to accept incoming network connections for it to communicate with the Console 1 plug-ins.

Please note that Console 1 is not using any *external* network traffic, like calling home or accessing Internet. All traffic occurs within your computer.

## Hardware Specifications

Connectors: USB connector (Type B)

Power Supply: USB bus powered

Power: 500 mA or less

Dimensions: 428 x 42 x 189 mm (W x H x D)

Weight: 1.95 kg

Included items: USB cable, Quick Start Guide  
with license code



# 1 1 END USER LICENSE AGREEMENT

This End User License Agreement ("Agreement") is a contract between you, either individual or single entity, and Softube AB ("Licensor"), a Swedish corporation regarding use of the accompanying software ("Software"). Please read through this Agreement carefully before installation and use of the Software. BY ACCEPTANCE OF THIS AGREEMENT OR by installation and/or use of the Software (THE EARLIEST OF SUCH ACTS CONSTITUTING THE EFFECTIVE DATE OF THIS AGREEMENT), you agree to be bound by the terms and conditions of this Agreement. Should you not accept the terms and conditions set forth in this Agreement, do not install the Software and delete the Software from your computer and any copies thereof.

1. The Software may not be used without a software license key. You may purchase a software license key from Licensor at the terms and conditions from time to time applied by the Licensor, which entitles you to use the Software on a perpetual basis ("Perpetual License"). You may also receive a temporary software license key which is intended to give you an opportunity to test and evaluate the Software ("Evaluation License"). Such Evaluation License is provided at the terms and conditions from time to time applied by Licensor. Please note that you are responsible for the software license key received and Licensor will not replace any lost software license keys.
2. Licensor and/or its licensors own all copyrights in and to the Software. The Software is protected by copyright laws and international copyright treaties, as well as other intellectual property laws and treaties. Any and all intellectual and other property rights to and in the Software vest in and shall remain vested in Licensor or its licensors. The Software is licensed, not sold.
3. Title and copyrights in and to the Software (including any images, photographs, animations, video, audio, music, and text incorporated into the Software), accompanying printed materials, and any copies End-Users are permitted to make herein are owned by Licensor or its licensors.
4. No right, title or interest in or to any trademark, service mark, logo, or trade name of Licensor or its licensors is granted to End-Users.
5. The End-User is granted a non-exclusive and non-transferable right to use the Software.
6. The End-User may not copy or reproduce the Software. The End-User may not transfer, sell, distribute, lend, rent, lease or in other way, directly or indirectly, dispose of the Software or any derivative work of the Software.
7. The End-User may not alter or modify the Software and may not analyze, reverse engineer, decompile or disassemble the Software or any part of the Software, incorporate the Software into any other application software, or print out the Software, except and only to the extent that such activity is expressly permitted by applicable law notwithstanding this limitation.
8. The End-User may use the Software for only as many simultaneous users, servers or other limiting parameters as are set out in the instructions of Licen-

sor according to the Agreement or otherwise.

9. The Software is installed on computer(s)/server(s) according to what is set forth in the agreement with the Licensor.
10. Except as provided for the Evaluation License, the license will continue until it is terminated. Licensor may terminate the license if you fail to comply with the terms of this Agreement. You may terminate the license at any time and for any reason. Upon termination by either party, you must delete the Software from your computer and any copies thereof.
11. Licensor warrants the media on which the Software is recorded to be free from defects in material and workmanship under normal use for a period of ninety (90) days from the date of purchase as evidenced by a copy of the receipt. Licensor's entire liability and your exclusive remedy will be replacement of the media not meeting the Licensor's limited warranty and which is returned to Licensor or an authorized representative of Licensor with a copy of the receipt. Licensor will have no responsibility to replace any media damaged by accident, abuse or misapplication.
12. The Software is provided strictly "AS IS," without warranty of any kind. ALL EXPRESSED OR IMPLIED REPRESENTATIONS AND WARRANTIES, INCLUDING ANY IMPLIED WARRANTY OF MERCHANTABILITY, FITNESS FOR A PARTICULAR PURPOSE OR NON-INFRINGEMENT, ARE HEREBY EXCLUDED. LICENSOR DOES NOT WARRANT THAT THE FUNCTIONS CONTAINED IN THE SOFTWARE WILL MEET YOUR REQUIREMENTS, OR THAT THE OPERATION OF THE SOFTWARE WILL BE INTERRUPTED OR ERROR-FREE, OR THAT DEFECTS IN THE SOFTWARE WILL BE CORRECTED. FURTHERMORE, LICENSOR DOES NOT WARRANT OR MAKE ANY REPRESENTATIONS REGARDING THE USE OR THE RESULTS OF THE USE OF THE SOFTWARE OR RELATED DOCUMENTATIONS IN TERMS OF THEIR CORRECTNESS, ACCURACY, RELIABILITY OR OTHERWISE. NOR ORAL OR WRITTEN INFORMATION OR ADVICE GIVEN BY LICENSOR OR AN AUTHORIZED REPRESENTATIVE OF LICENSOR SHALL CREATE A WARRANTY OR IN ANY WAY INCREASE THE SCOPE OF THIS WARRANTY. SHOULD THE SOFTWARE PROVE DEFECTIVE, YOU (AND NOT LICENSOR OR AN AUTHORIZED REPRESENTATIVE OF THE LICENSOR) ASSUME THE JURISDICTIONS. SOME STATES DO NOT ALLOW THE EXCLUSION OF IMPLIED WARRANTY, SO THE ABOVE EXCLUSION MAY NOT APPLY TO YOU.
13. NEITHER LICENSOR NOR ITS LICENSORS SHALL BE LIABLE FOR ANY DAMAGES SUFFERED BY YOU OR ANY THIRD PARTY AS A RESULT OF USE OR INABILITY TO USE THE SOFTWARE. IN NO EVENT WILL LICENSOR NOR ITS LICENSORS BE LIABLE FOR ANY LOST REVENUE, PROFIT OR ANTICIPATED SAVINGS, DATA, OR FOR DIRECT, INDIRECT, SPECIAL, CONSEQUENTIAL, INCIDENTAL OR PUNITIVE DAMAGES, HOWEVER CAUSED AND REGARDLESS OF THE THEORY OF LIABILITY, ARISING OUT OF THE USE OF OR INABILITY TO USE SOFTWARE, EVEN IF THAT PARTY HAS BEEN ADVISED OF THE POSSIBILITY OF SUCH DAMAGES. IN ANY CASE LICENSORS ENTIRE LIABILITY UNDER ANY PROVISION OF THIS AGREEMENT SHALL BE LIMITED TO THE AMOUNT ACTUALLY PAID BY YOU TO LICENSOR FOR THE SOFTWARE LICENCE KEY.
14. This Agreement shall be governed and construed in accordance with the laws of Sweden.

## Acknowledgements and Licenses

**zlib.h** interface of the 'zlib' general purpose compression library version 1.2.8, April 28th, 2013. Copyright © 1995-2013 Jean-loup Gailly and Mark Adler

Portions of this software are copyright © 2006 **The FreeType Project** ([www.freetype.org](http://www.freetype.org)). All rights reserved.

**WonderGUI** used under commercial license © Tord Jansson

**libpng** versions 1.2.6, August 15, 2004, through 1.6.12, June 12, 2014, are copyright © 2004, 2006-2014 Glenn Randers-Pehrson, and are distributed according to the same disclaimer and license as libpng-1.2.5 with the following individual added to the list of contributing authors: Cosmin Truta, Simon-Pierre Cadieux, Eric S. Raymond, Gilles Vollant, Tom Lane, Glenn Randers-Pehrson, Willem van Schaik, John Bowler, Kevin Bracey, Sam Bushell, Magnus Holmgren, Greg Roelofs, Tom Tanner, Andreas Dilger, Dave Martindale, Guy Eric Schalnat, Paul Schmidt, Tim Wegner

Some code copyright © 2008 The **NetBSD Foundation**, Inc.

**VST** is a trademark and software of Steinberg Media Technologies GmbH

**Mac OS X headers** are covered under the Apple Public Source License (APSL) available at <http://www.publicsource.apple.com/apsl/>



# SOFTUBE LIMITED HARDWARE WARRANTY

1. Softube warrants to the end user Customer this hardware product against defects in materials and workmanship for a period of one (1) year after the date of the original purchase from Softube or from a channel authorized by Softube, provided the hardware product is unused at the time of purchase.

2. If a defect exists, at its option Softube will (a) repair the product at no charge, using new or refurbished replacement parts, (b) exchange the product with a product that is new or which has been manufactured from new or serviceable used parts and is at least functionally equivalent to the original product, or (c) refund the purchase price of the product.

3. A replacement product assumes the remaining warranty of the original product or 90 days, whichever provides longer coverage for the Customer. When a product or part is exchanged, any replacement item becomes the Customer's property and the replaced item Propellerhead's. When a refund is given, Customer's product becomes Softube's property.

4. The Limited Warranty does not apply to any non-Softube hardware product or any software, even if packaged or sold with the Softube hardware. Manufacturers, suppliers, or publishers, other than Softube, may provide their own warranties to the end user purchaser, but Softube, in so far as permitted by law, provides their products "as is". Software distributed by Softube with or without the Softube brand name (including, but not limited to system software) is not covered under this Limited Hardware Warranty. Refer to the Softube End User License Agreement for details of rights with respect to Softube software use.

Softube does not warrant that the operation of the product will be uninterrupted or error free. Softube is not responsible for damage arising from failure to follow instructions relating to the product's use.

5. It is the responsibility of the Customer to keep a separate backup copy of the system software, application software and data, and disable any security passwords. Customer is responsible for reinstalling all such software, data and passwords. Data recovery is not included in the warranty service and Softube is not responsible for data that may be lost or damaged during transit or during a repair.

6. This Softube Limited Hardware Warranty applies only to hardware products manufactured by or for Softube that can be identified by the "Softube" trademark, trade name, or logo affixed to them. Softube Limited Hardware Warranty does not apply to any non-Softube hardware products or any software, even if packaged or sold with Softube hardware. Non-Softube manufacturers, suppliers, or publishers may provide their own warranties.

7. This warranty does not apply: to damage caused by accident, abuse, misuse, misapplication; to damage caused by service (including upgrades and expansions) performed by anyone who is not a Softube Authorized Service Provider; to a product or part that has been modified without written permission of Softube; or if any Softube serial number has been removed or defaced.

8. To the extent permitted by law, this warranty and the remedies set forth

above are exclusive and in lieu of all other warranties, remedies and conditions, whether oral or written, statutory, express or implied. As permitted by applicable law, Softube specifically disclaims any and all statutory or implied warranties, including, without limitation, warranties of merchantability and fitness for a particular purpose and warranties against hidden or latent defects. If Softube cannot lawfully disclaim statutory or implied warranties then to the extent permitted by law, all such warranties shall be limited in duration to the duration of the express warranty and to the repair or replacement service as determined by Softube in its sole discretion. No Softube distributor, agent, or employee is authorized to make any modification, extension, or addition to this warranty. If any term is held to be illegal or unenforceable, the legality or enforceability of the remaining terms shall not be affected or impaired. Except as provided in this warranty and to the maximum extent permitted by law, Softube is not responsible for direct, special, incidental or consequential damages resulting from any breach of warranty or condition, or under any other legal theory, including but not limited to loss of use; loss of revenue; loss of actual or anticipated profits (including loss of profits on contracts); loss of the use of money; loss of anticipated savings; loss of business; loss of opportunity; loss of goodwill; loss of reputation; loss of, damage to or corruption of data; or any indirect or consequential loss or damage howsoever caused including the replacement of equipment and property, any costs of recovering, programming or reproducing any program or data stored in or used with the Softube product, and any failure to maintain the confidentiality of data stored on the product. The foregoing limitation shall not apply to death or personal injury claims, or any statutory liability for intentional and gross negligent acts and/or omissions. Softube disclaims any representation that it will be able to repair any product under this warranty or make a product exchange without risk to or loss of programs or data.

## Obtaining warranty service

Please visit the web site [www.softube.com](http://www.softube.com) to access FAQ and documentation. Here you will find online help and guidance on how to operate and troubleshoot your product. If the product is still not functioning properly after making use of these resources, access the Support section at [www.softube.com](http://www.softube.com) for instructions on how to obtain warranty service. You must follow Softube warranty processes to obtain full warranty service.

For consumers, who are covered by consumer protection laws or regulations in their country of purchase or, if different, their country of residence, the benefits conferred by this warranty are in addition to all rights and remedies conveyed by such consumer protection laws and regulations. Some countries, states and provinces do not allow the exclusion or limitation of incidental or consequential damages or allow limitations on how long an implied warranty or condition may last, so the limitations or exclusions described herein may not apply to you.



**ROCK 'N'  
ROLL**

*Scientists*

*in MONO or STEREO*

**MIX WITH CONFIDENCE**

LINKÖPING SWEDEN

 **Softube**