



## User Manual



# DeepMind 12

True Analog 12-Voice Polyphonic Synthesizer with  
 4 FX Engines, 2 OSCs and LFOs per Voice, 3 ADSR Generators,  
 8-Channel Modulation Matrix, 32-Step Sequencer,  
 Tablet Remote Control and Built-In WiFi

# Table of Contents

<b>Thank you.....</b>	<b>2</b>
<b>Important Safety Instructions .....</b>	<b>3</b>
<b>Legal Disclaimer .....</b>	<b>3</b>
<b>Limited warranty.....</b>	<b>3</b>
<b>About the DeepMind 12.....</b>	<b>4</b>
<b>1. Introduction .....</b>	<b>5</b>
<b>2. Features.....</b>	<b>5</b>
<b>3. Controls .....</b>	<b>7</b>
<b>4. Program Management .....</b>	<b>11</b>
<b>5. Playing Guide.....</b>	<b>15</b>
<b>6. Signal Path / Voice Structure .....</b>	<b>17</b>
<b>7. Menu System .....</b>	<b>19</b>
<b>8. Programming.....</b>	<b>36</b>
<b>9. Effects Reference Guide .....</b>	<b>79</b>
<b>10. Short-cuts.....</b>	<b>102</b>
<b>11. Applications .....</b>	<b>103</b>
<b>12. DAW MIDI Configuration.....</b>	<b>108</b>
<b>13. System Block Diagram .....</b>	<b>109</b>
<b>14. Connection Wiring Diagrams .....</b>	<b>111</b>
<b>15. Technical Specifications.....</b>	<b>112</b>
<b>16. MIDI Commands .....</b>	<b>113</b>
<b>17. MIDI NRPN Commands .....</b>	<b>117</b>
<b>18. Global Commands .....</b>	<b>120</b>
<b>19. MIDI SysEx Commands .....</b>	<b>121</b>
<b>20. Firmware Update .....</b>	<b>127</b>
<b>21. Troubleshooting .....</b>	<b>127</b>
<b>22. Bootloader Menu.....</b>	<b>128</b>
<b>23. Definition of Terms.....</b>	<b>129</b>
<b>24. Appendix 1 - Octave Shifting .....</b>	<b>133</b>
<b>25. Appendix 2 - ARP/SEQ/LFO Sync Timing .....</b>	<b>133</b>

## Thank you

Thank you very much for expressing your confidence in BEHRINGER products by purchasing the DeepMind 12 analog polyphonic synthesizer—our True Analog 12-Voice Polyphonic Synthesizer with 4 FX Engines, 2 OSCs and LFOs per Voice, 3 ADSR Generators, 8-Channel Modulation Matrix, 32-Step Sequencer, Tablet Remote Control and Built-In Wi-Fi.

## EN Important Safety Instructions



Terminals marked with this symbol carry electrical current of sufficient magnitude to constitute risk of electric shock.

Use only high-quality professional speaker cables with ¼" TS or twist-locking plugs pre-installed. All other installation or modification should be performed only by qualified personnel.



This symbol, wherever it appears, alerts you to the presence of uninsulated dangerous voltage inside the enclosure - voltage that may be sufficient to constitute a risk of shock.



This symbol, wherever it appears, alerts you to important operating and maintenance instructions in the accompanying literature. Please read the manual.



### Caution

To reduce the risk of electric shock, do not remove the top cover (or the rear section). No user serviceable parts inside. Refer servicing to qualified personnel.



### Caution

To reduce the risk of fire or electric shock, do not expose this appliance to rain and moisture. The apparatus shall not be exposed to dripping or splashing liquids and no objects filled with liquids, such as vases, shall be placed on the apparatus.



### Caution

These service instructions are for use by qualified service personnel only. To reduce the risk of electric shock do not perform any servicing other than that contained in the operation instructions. Repairs have to be performed by qualified service personnel.

1. Read these instructions.
2. Keep these instructions.
3. Heed all warnings.
4. Follow all instructions.
5. Do not use this apparatus near water.
6. Clean only with dry cloth.
7. Do not block any ventilation openings. Install in accordance with the manufacturer's instructions.
8. Do not install near any heat sources such as radiators, heat registers, stoves, or other apparatus (including amplifiers) that produce heat.

9. Do not defeat the safety purpose of the polarized or grounding-type plug. A polarized plug has two blades with one wider than the other. A grounding-type plug has two blades and a third grounding prong. The wide blade or the third prong are provided for your safety. If the provided plug does not fit into your outlet, consult an electrician for replacement of the obsolete outlet.

10. Protect the power cord from being walked on or pinched particularly at plugs, convenience receptacles, and the point where they exit from the apparatus.

11. Use only attachments/accessories specified by the manufacturer.



12. Use only with the cart, stand, tripod, bracket, or table specified by the manufacturer, or sold with the apparatus. When a cart is used, use caution when moving the cart/apparatus combination to avoid

injury from tip-over.

13. Unplug this apparatus during lightning storms or when unused for long periods of time.

14. Refer all servicing to qualified service personnel. Servicing is required when the apparatus has been damaged in any way, such as power supply cord or plug is damaged, liquid has been spilled or objects have fallen into the apparatus, the apparatus has been exposed to rain or moisture, does not operate normally, or has been dropped.

15. The apparatus shall be connected to a MAINS socket outlet with a protective earthing connection.

16. Where the MAINS plug or an appliance coupler is used as the disconnect device, the disconnect device shall remain readily operable.



17. Correct disposal of this product: This symbol indicates that this product must not be disposed of with household waste, according to the WEEE Directive (2012/19/EU) and your national law. This product

should be taken to a collection center licensed for the recycling of waste electrical and electronic equipment (EEE). The mishandling of this type of waste could have a possible negative impact on the environment and human health due to potentially hazardous substances that are generally associated with EEE. At the same time, your cooperation in the correct disposal of this product will contribute to the efficient use of natural resources. For more information about where you can take your waste equipment for recycling, please contact your local city office, or your household waste collection service.

18. Do not install in a confined space, such as a book case or similar unit.

19. Do not place naked flame sources, such as lighted candles, on the apparatus.

20. Please keep the environmental aspects of battery disposal in mind. Batteries must be disposed-of at a battery collection point.

21. Use this apparatus in tropical and/or moderate climates.

## LEGAL DISCLAIMER

MUSIC Group accepts no liability for any loss which may be suffered by any person who relies either wholly or in part upon any description, photograph, or statement contained herein. Technical specifications, appearances and other information are subject to change without notice. All trademarks are the property of their respective owners. MIDAS, KLARK TEKNIK, LAB GRUPPEN, LAKE, TANNOY, TURBOSOUND, TC ELECTRONIC, TC HELICON, BEHRINGER, BUGERA and DDA are trademarks or registered trademarks of MUSIC Group IP Ltd. © MUSIC Group IP Ltd. 2017 All rights reserved.

## LIMITED WARRANTY

For the applicable warranty terms and conditions and additional information regarding MUSIC Group's Limited Warranty, please see complete details online at [music-group.com/warranty](http://music-group.com/warranty).

## About the DeepMind 12

The DeepMind 12 is a True Analog 12-Voice Polyphonic Synthesizer with TC ELECTRONIC / KLARK TEKNIK FX and iPad Remote Control.

The DeepMind 12 was created to serve the creative needs of players, performers, artists, sound designers, engineers and producers.

The DeepMind 12 offers all the features of a traditional analog polyphonic synthesizer, and adds incredible new features to enhance and expand the creative possibilities.

- Classic polyphonic synthesizer with 12 true analog oscillators for insanely fat and authentic sounds.
- 4 simultaneous world-class TC ELECTRONIC and KLARK TEKNIK FX with over 30 algorithms including Reverb, Chorus, Flanger, Phaser, Delay and multi-band Distortion.
- 12 voices with 2 OSCs per voice with oscillator sync mode 2 LFOs per voice with 7 waveform shapes, key sync, MIDI sync and envelope auto-triggering.
- 3 ADSR generators per voice for control of VCF, VCA and MOD envelopes.
- Flexible 8-channel modulation matrix with 22 sources and 129 destinations including effects parameters.
- 32-step control sequencer with adjustable slew rate and MIDI sync.
- Full remote control via iPad\*/PC/Mac and selected Android\* Application over USB, MIDI or built-in Wi-Fi for extended parameter control.
- 49 semi-weighted full-size keys featuring velocity sensitivity and after-touch.
- Pure analog signal path with legendary IR3109-style VCFs and stereo VCAs.
- OSC 1 generates sawtooth and square/pulse waveforms with pulse width modulation.
- OSC 2 generates square/pulse waveforms with tone modulation.
- Selectable dual slope 12/24 dB analog low pass filter per voice with adjustable resonance.
- Envelope faders seamlessly transform individual envelope segments between linear, exponential and reverse exponential curves.
- Powerful unison and poly modes with detune, pan spread and drift parameters featuring up to 12 voices per note.
- Global noise generator dramatically expands waveform generation.
- Incredible polyphonic portamento with flexible fixed rate, fixed time and exponential pitch glide modes.
- Sophisticated arpeggiator with tap tempo button and user configurable pattern modes.
- Chord and Poly Chord memories enable polyphonic performances from monophonic playing styles.
- Global variable 6 dB high pass filter with bass boost switch.
- 26 sliders and one switch per function give direct and real-time access to all important parameters.
- Spring-loaded pitch and assignable modulation wheels provide total hands-on performance.
- LCD Display with encoder, navigation switches and data value fader for rapid menu parameter editing and program selection.
- 1024 user program memories with "compare and match" feature to quickly match all analog controls to values stored in program.
- Fully servo-balanced stereo outputs for highest signal integrity.
- CV/pedal input for connection to modular systems.
- Comprehensive MIDI implementation (including NRPN/CC control of all parameters and bulk load/save).
- Integrated and configurable Wi-Fi client / Access point allows easy and secure connection to home network.
- 3-Year Warranty Program\*.
- Designed and engineered in the U.K.

# 1. Introduction

The DeepMind 12 is a True Analog 12-Voice Polyphonic Synthesizer with 4 FX Engines, 2 OSCs and LFOs per Voice, 3 ADSR Generators, 8-Channel Modulation Matrix, 32-Step Sequencer, Tablet Remote Control and Built-In Wi-Fi.

The DeepMind 12 was created to serve the creative needs of players, performers, artists, sound designers, engineers and producers.

The DeepMind 12 offers all the features of a traditional analog polyphonic synthesizer, and adds incredible new features to enhance and expand the creative possibilities.



**This manual first describes the terminology used, so that you understand the unit and its functions. Please read the manual carefully and keep it for future reference.**

## 1.1 Before you get started

### 1.1.1 Shipment

The DeepMind 12 was carefully packed in the factory to guarantee safe transport. Nevertheless, we recommend that you carefully examine the packaging and its contents for any signs of physical damage, which may have occurred during transit.



**If the unit is damaged, please do NOT return it to us, but notify your dealer and the shipping company immediately, otherwise claims for damage or replacement may not be granted.**

### 1.1.2 Initial operation

Be sure that there is enough space around the unit for cooling purposes and, to avoid over-heating, please do not place the DeepMind 12 on high-temperature devices such as radiators or power amps.



**Blown fuses must only be replaced by fuses of the same type and rating!**

The console is connected to the mains via the supplied cable. It meets the required safety standards.

◆ **Please make sure that all units have a proper ground connection. For your own safety, never remove or disable the ground conductor from the unit or the AC power cord.**

## 1.2 The product manual

The product manual is designed to give you both an overview of the DeepMind 12 analog polyphonic synthesizer, as well as detailed information on each of the controls and parameters. You will find an overview of the physical control elements in the next chapter.

## 1.3 Preparation



**Remember to turn your monitors / loudspeakers on last when powering up your system, and turn your monitors / loudspeakers off first when powering down your system.**

# 2. Features

## 2.1 Voices

- Twelve independent Voices.
- Two discrete OSCs per voice.
- OSC 1 : Simultaneous Sawtooth and Pulse / Square function.
- OSC 2 : Square with Tone Mod wave shape function.
- Variable Pulse width (OSC1) Tone Mod (OSC2) manual and variable modulation depth for each OSC.
- Hard sync option: oscillator 2 either syncs to oscillator 1 or can free run.
- Variable Pitch offset for OSC2 (+/- 1 octave) for harmonic richness.
- Three octave ranges per OSC, 16", 8", 4".
- OSC drift amount for controllable tuning instability.
- Unison modes (1,2,3,4,6,12 voice) with detune for huge sounds.
- Variable Oscillator 2 level.

## 2.2 Filters

- 2/4 pole resonant Midas Low-Pass Filter.
- Continuous High-Pass Filter frequency.
- LP Filter can be driven into self-oscillation.
- Switchable Bi-polar filter envelope depth.
- Variable Keyboard / Frequency tracking.
- Switchable +12 db Bass Boost for massive low end.

## 2.3 Envelopes

- Dedicated VCA, VCF and auxiliary (MOD) envelope Four-stage (ADSR) envelope generator with continuously variable curves for unique flexibility.
- Trigger modes (Key, Loop, Control Sequencer, LFO1, LFO2).

## 2.4 LFO

- Two LFOs per voice.
- Variable slew rate.
- Mono / Poly / Spread modes for linking and unlinking LFO phase across voices.
- High maximum LFO rate for cross mod type effects.
- Sine, Triangle, Square, Ramp Up, Ramp Down, Sample and Hold, Sample and Glide.
- Key Sync on/off.
- Clock sync (internal or external MIDI clock).
- Delay and Fade in Per LFO.
- High maximum LFO rate which can track note number via mod matrix for cross mod type effects.

## 2.5 VCA

- Stereo VCA per voice with overall pan spread control and individual voice pan modulation.

## 2.6 Effects

- Over 30 high grade studio quality chainable effects.
- Effects from TC Electronic, Behringer X32 and Midas Consoles.
- 4 Effects per Program.
- True bypass.
- Tap Tempo.
- Many effect parameters are a destination in the Mod Matrix allowing endless possibilities.
- 10 different Effects configurations including shimmer routings with feedback.
- TC-DeepVRB, Ambience, Room Rev, VintageRm, Hall Rev, Chamber Rev, Plate Rev, Rich Plate, Gated Rev, Reverse, ChorusVerb, DelayVerb, FlangeVerb, 4Band EQ, Enhancer, FairComp, MulBndDist, RackAmp, EdisonEX1, Auto-Pan, NoiseGate, Delay, 3TapDelay, 4TapDelay, T-RayDelay, ModDlyRev, Chorus, Chorus-D, Flanger, Phaser, MoodFilter, Dual Pitch, RotarySpkr.

## 2.7 Mod Matrix

- 8 Mod matrix busses.

### Modulation Sources (22):

- Pitch Bend, Mod Wheel, Foot Ctrl, Breath Controller, Pressure, LFO 1, LFO 2, VCA Envelope, VCF Envelope, Mod Envelope (Auxiliary Envelope), Note Number, Note Velocity, Ctrl Sequencer, LFO1 (unipolar), LFO2 (unipolar), LFO1 Fade, LFO2 Fade, Note Off Velocity, Voice Number, CC X-Axis, CC Y-Axis, CC Z-Axis.

### Modulation Destinations (122):

- LFO1 Rate, LFO1 Delay, LFO1 Slew, LFO2 Rate, LFO2 Delay, LFO2 Slew, OSC1+2 Pitch, OSC1 Pitch, OSC2 Pitch, LFO Depth, PWM Depth, Tone Mod Depth, OSC2 Pulse Modulation Depth, Portamento Time, VCF Frequency, VCF Resonance, VCF Envelope, VCF LFO, All Envelope Rates, All Envelope Attacks, All Envelope Decays, All Envelope Sustains, All Envelope Releases, Envelope (1-3) Rates, Envelope (1-3) Curves, Envelope (1-3) Attack, Envelope (1-3) Decay, Envelope (1-3) Sustain, Envelope (1-3) Release, Envelope (1-3) Attack Curve, Envelope (1-3) Decay Curve, Envelope (1-3) Sustain Curve, Envelope (1-3) Release Curve, VCA All, VCA Active, VCA Envelope Depth, LFO Pan Spread, VCA Pan, OSC2 Level, Noise Level, HP Frequency, Unison Detune, Modulation 1-8 Depth, Effects (1-4) All loaded FX Parameter(1-12).

## 2.8 Keyboard

- Full-sized, semi-weighted, 49-note keyboard with note on and off velocity, and aftertouch.
- Backlit pitch and mod wheel.
- Spring-loaded pitch wheel with selectable range per program (1 to 24 semitones up and down).
- Transpose controls for an 8-octave range.
- Polyphonic Portamento.

## 2.9 PSU

- IEC mains connection - No Wall Wart.

## 2.10 Clock

- Master clock with tap tempo.
- BPM control and display.
- MIDI clock sync

## 2.11 Arpeggiator

- Variable Gate Time.
- Up to six octave range.
- 32 Preset and 32 User programmable rhythmic patterns with up to 32 steps and rests.
- Variable swing function.
- Arpeggiator Modes :
  - UP, DOWN, UP-DOWN, UP-INV, DOWN-INV, UP-DN-INV, UP-ALT, DOWN-ALT, RAND, AS-PLAYED, CHORD.
- User Pattern.
- Arp Clock options : 1/2, 3/8, 1/3, 1/4, 3/16, 1/6, 1/8, 3/32, 1/12, 1/16, 1/24, 1/32, 1/48.
- Hold switch latches held notes on.

## 2.12 Chord / Poly Chord

- Maps chords to trigger keys.
- Up to 12 notes per chord.
- Enough storage for 36x 6 note chords.

## 2.13 Control sequencer

- Up to 32 steps and rests. Output routable via the mod matrix.

## 2.14 Editor

- Comprehensive Apple iPad, Apple MacOS and Windows PC editor.

## 2.15 Program Memory

- 1024 Programs arranged in 8 Banks of 128 Programs.

## 2.16 Input / Output

- Built in USB Midi Interface.
- USB for iPad/PC/Mac connection MIDI.
- USB for bidirectional MIDI communication.
- Flexible MIDI routing.
- Expression Pedal / CV (0-5v) in.
- Left and right balanced audio outputs (2 x 1/4" TRS).
- Headphone output (stereo, 1/4" TRS).
- MIDI IN, OUT, and THRU ports.
- Configurable Wi-Fi client / Access point allows easy and secure connection to home network.
- Wireless control with RTP (Real-Time Protocol) MIDI support.

### 3. Controls

#### 3.1 Top Controls

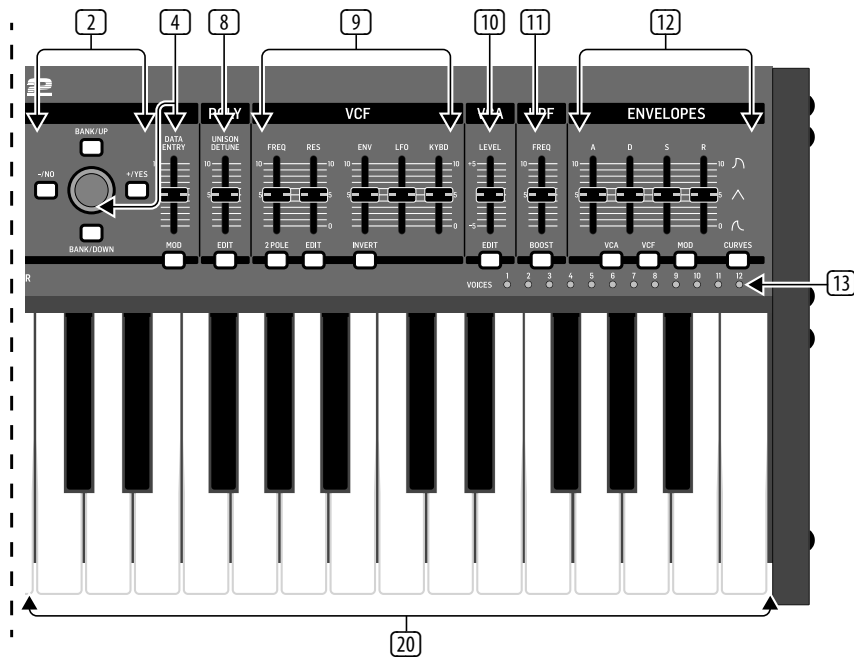
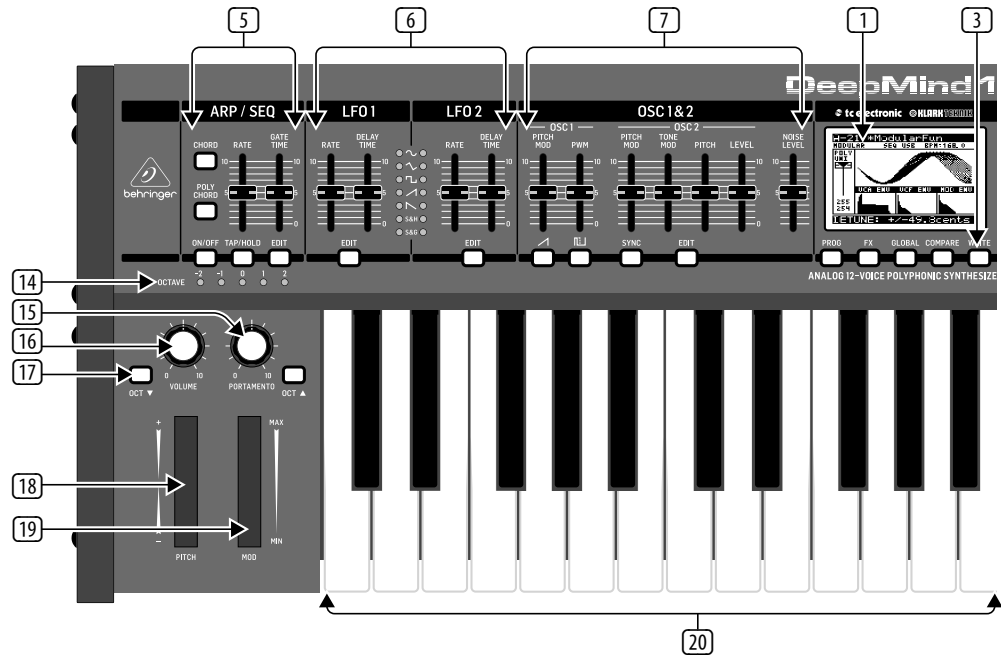

- 1 DISPLAY** - this large backlit LCD screen shows the synthesizer status, parameters, and the five main menus. The contrast and brightness are adjustable on the PANEL SETTINGS page of the GLOBAL menu.
- 2 NAVIGATION** - navigate within the display menus using the UP, DOWN, +/- YES and -/NO buttons.
- 3 MENUS** - these switches allow access to the display menus.
- PROG MENU** - the main display of the synthesizer. Shows the current program, the currently adjusted parameter and a visual representation of the parameter and the three envelopes.
- FX MENU** - add up to four effects from the list available. Change the effects routing by selecting one of the ten MODEs available. Each of the effects has individual controls for all parameters.
- GLOBAL MENU** - view and adjust settings for the synthesizer. There are five pages, CONNECTIVITY, KEYBOARD, PEDAL, PANEL and SYSTEM.
- COMPARE MENU** - in this menu, you can compare the current program with the stored program and see the difference in physical fader positions.
- WRITE MENU** - in this menu, you can write the current program settings to the program library. You can also rename the program and set its category type.
- 4 DATA ENTRY** - selected parameters on the display are adjusted using the rotary knob or the fader. The rotary knob has a click which allows very accurate control. The fader allows rapid adjustment across the full range.
- MOD** - this switch opens the modulation matrix on the display and allows up to 8 modulations to be created from the list of sources and destinations.
- 5 ARP/SEQ** - this area controls the arpeggiator and the control sequencer.
- ON/OFF** - when activated, this generates an arpeggio based on pressed keys. Note - the control sequencer is turned on from its edit page only.
- RATE** - adjusts the rate of the arpeggiator / sequencer in beats per minute (BPM).
- GATE TIME** - adjusts the duration of the note played based on a percentage of the time between triggered notes.
- CHORD** - allows you to play any chord with a single key. The chord is given a root note and mapped across the keyboard.
- POLY CHORD** - allows you to play multiple chords from multiple keys. The chords are mapped to individual keys.
- TAP/HOLD** - tap this button in time with your performance to set the rate/BPM, or press and hold to engage the HOLD function.
- EDIT** - this allows additional arpeggiator/control sequencer parameters to be edited from the main display.
- 6 LFO 1 and 2** - low frequency oscillators used to modulate or control other parameters.
- RATE** - this sets the rate, or speed of the LFO.
- DELAY TIME** - the duration of time which will elapse before the LFO starts.
- EDIT** - this allows additional LFO parameters to be edited from the main display.
- LFO WAVEFORMS** - these LEDs indicate the type and status of the waveforms produced by each LFO.
- 7 OSC 1 & 2** - These analog full range oscillators create waveforms which are the sound source of the synthesizer.
- OSC 1 & 2 PITCH MOD** - amount of pitch modulation applied to respective OSC.
- OSC 1 SQUAREWAVE** - this switch turns the square wave output for OSC 1 on/off.
- OSC 1 PWM** - amount of pulse width modulation applied to the OSC 1 square wave.
- OSC 1 SAWTOOTH** - this switch turns the sawtooth output for OSC 1 on/off.
- OSC 2 TONE MOD** - amount of tone modulation applied to OSC 2.
- OSC 2 PITCH** - controls the base pitch of OSC 2.
- OSC 2 LEVEL** - controls the level of OSC 2.
- NOISE LEVEL** - controls the amount of white noise added to the oscillators.
- EDIT** - this allows additional OSC parameters to be edited from the main display.
- 8 POLY** - this area is used to control the polyphony of the synthesizer.
- UNISON DETUNE** - when voices are playing in unison, this adjusts the amount of detuning between the voices.
- EDIT** - this allows additional POLY parameters to be edited from the main display.
- 9 VCF** - the voltage controlled low pass filter used to filter high frequencies from the sound of the synthesizer.
- FREQ** - adjusts the cut-off frequency of the filter.
- 2-POLE** - changes the roll off slope of the filter from the default 4-POLE mode to a 2-POLE mode.
- RES** - adjusts the resonance of the filter cut-off point.
- EDIT** - allows additional VCF parameters to be edited from the main display.
- ENV** - adjusts the level of the VCF ENVELOPE which controls the filter cut-off frequency.
- INVERT** - used to invert the polarity of the VCF envelope applied to the filter cut-off frequency.
- LFO** - adjusts the depth of the selected LFO waveform applied to the filter cut-off frequency.
- KYBD** - adjusts the amount of keyboard tracking to be applied to the filter cut-off frequency.
- 10 VCA** - the voltage controlled amplifier used to control the output level.
- LEVEL** - controls the output level of the VCA.
- EDIT** - this allows additional VCA parameters to be edited from the main display.
- 11 HPF** - the voltage controlled high pass filter used to filter low frequencies from the sound of the synthesizer.
- FREQ** - used to adjust the frequency of the high pass filter.
- BOOST** - this switch applies a +12 dB bass boost to the signal path
- 12 ENVELOPE** - these are the three envelopes used to modulate other parameters.
- A [ATTACK]** - controls the attack time of the envelope.
- D [DECAY]** - controls the decay time of the envelope.
- S [SUSTAIN]** - controls the sustain level of the envelope.
- R [RELEASE]** - controls the release time of the envelope.
- VCA** - selects the envelope used to control the voltage controlled amplifier.



**VCF** - selects the envelope used to control the voltage controlled filter.

**MOD** - selects the envelope used for user specific modulation.

**CURVES** - changes the ADSR controls to affect the associated curves for each stage of the envelope.

13 **VOICES** - these LEDs show which voices are active as keys are played.

14 **OCTAVE** - these LEDs show the octave shift applied to the keyboard.

15 **PORTAMENTO** - changes the slide time between played notes.

16 **VOLUME** - controls the output level of the synthesizer.

17 **OCTAVE UP/DOWN** - raise or lower the keyboard's pitch range in steps of an octave.

18 **PITCH BEND WHEEL** - this spring loaded wheel allows you to lower / raise the pitch expressively.

19 **MOD WHEEL** - used for expressive modulation of parameters.

20 **KEYS** - 49 semi-weighted full-size keys featuring expressive velocity and after-touch.

### 3.2 Rear Panel

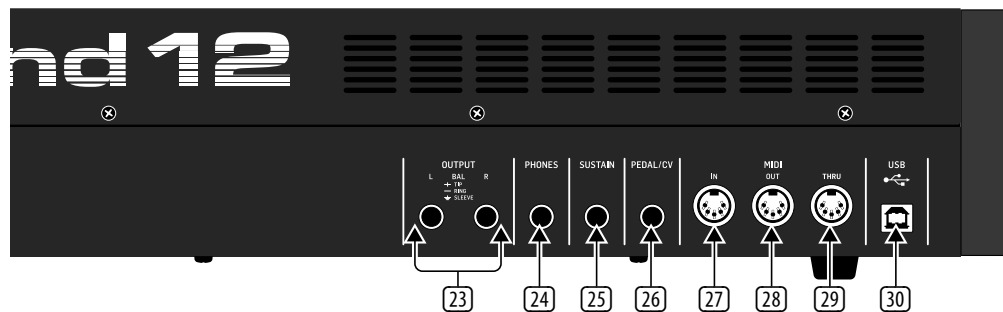
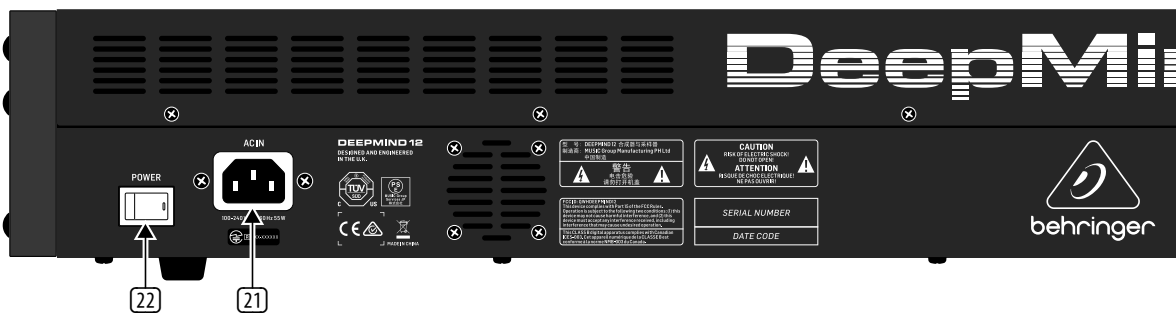

## Rear Panel

- 21 **POWER INPUT** - connect using the supplied power cable only.
- 22 **POWER SWITCH** - use this to turn the synthesizer on and off. Only turn it on after all connections have been made.
- 23 **OUTPUT L / R** - this is the main output of the synthesizer. It should be connected to your audio interface or sound system. Remember to turn your monitors / loudspeakers on last when turning on your system and turn your monitors / loudspeakers off first when turning your system off.
- 24 **PHONES** - the headphones output of the synthesizer follows the main output. Connect your headphones here. Ensure the volume control is at minimum when putting on headphones or when turning the synthesizer on or off.
- 25 **SUSTAIN** - this ¼" TS jack allows you to connect a sustain pedal, such as a normally-open switch.  
The operation of this pedal can be customized using the GLOBAL / PEDAL SETTINGS menu.
- 26 **PEDAL/CV** - this ¼" TRS jack allows you to connect an expression pedal.  
The operation of this pedal can be customized using the GLOBAL / PEDAL SETTINGS menu.
- 27 **MIDI IN** - this 5-pin DIN jack receives MIDI data from an external source. This will commonly be an external hardware sequencer, a computer equipped with a MIDI interface, etc.
- 28 **MIDI OUT** - this 5-pin DIN jack sends MIDI data to an external source. This will commonly be an external hardware sequencer, a computer equipped with a MIDI interface, etc.
- 29 **MIDI THRU** - this 5-pin DIN jack is used to pass through MIDI data received at the MIDI INPUT. This will commonly be sent to another synthesizer or drum machine assigned to a different DEVICE ID, or MIDI Channel.
- 30 **USB PORT** - this USB type B jack allows connection to a computer. The DeepMind 12 will show up as a class-compliant USB MIDI device, capable of supporting MIDI in and out. The DeepMind 12 does not require any additional drivers to work with Windows, Android, MacOS and iOS devices.

**USB MIDI IN** - accepts incoming MIDI data from an application.

**USB MIDI OUT** - sends MIDI data to an application.

## 4. Program Management

This chapter covers the program management for the DeepMind 12 analog polyphonic synthesizer. It is important to understand how to manage your programs and maintain your library.

### 4.1 Program Library

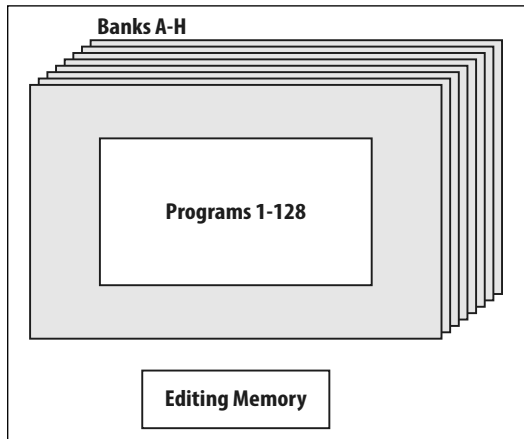

The DeepMind 12 contains a total of 1,024 programs. There are 8 Banks (A-H) of 128 programs. All programs can be overwritten as required, please consult the chapter on restoring factory defaults if you need to return the DeepMind 12 program library to its original state.

All current changes from the stored program are stored in temporary "Editing Memory". The changes are also placed into "Backup Memory" which can be used to recover unsaved programs.

**Note:** The DeepMind 12 Programs are stored in EEPROM memory and will be retained through a power cycle.

### 4.2 Selecting Programs

Press the PROG switch to open the PROG menu. This is also the screen which will be displayed when the DeepMind 12 is turned on.



The PROG (Programming) page will be displayed:

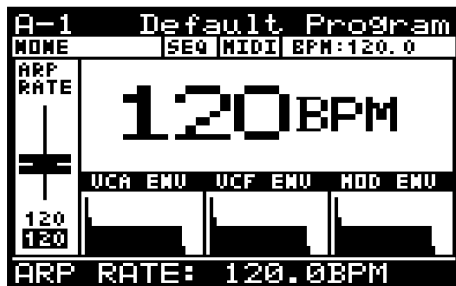

The PROG (Programming) page is the main display of the synthesizer. It shows the current program name, the category name, the currently adjusted parameter and a visual representation of the parameter plus the three envelopes.

There are three methods of changing the current program:

- Step forwards/backwards through programs using the -/NO and +/YES switches, or by stepping up and down through the banks using the BANK/UP and BANK/DOWN switches.
- Using the program browser.
- From an external device using a MIDI program change message.

#### 4.2.1 Using the Navigation Switches



Pressing -/NO or +/YES will load the previous/next program in the bank.

Pressing BANK/UP to BANK/DOWN will change banks.

#### 4.2.2 Using the Program Browser

To access the program browser, press and hold the PROG switch, then move the rotary knob (or press the GLOBAL switch).



**Note:** a help menu will appear while the PROG switch is held, showing additional guidance and commands:



The program browser will then appear:



When in program browser mode you can use the rotary knob to scroll through the list of programs. When you stop on a program it will be automatically loaded.

### 4.2.3 Using MIDI Program Change messages

You can change the program using a MIDI program change message. This special MIDI message can be sent from your Digital Audio Workstation (DAW) or from an external MIDI device which is capable of transmitting program change messages.

For details on the message please consult the section on MIDI commands.

## 4.3 Program Categories

Each program is assigned to a category from the list of options below:

- **NONE** - No category information is stored.
- **BASS** - Used for bass sounds.
- **PAD** - Used for pad sounds.
- **LEAD** - Used for lead sounds.
- **MONO** - Used for monophonic sounds.
- **POLY** - Used for polyphonic sounds.
- **STAB** - Used for stab sounds.
- **SFX** - Used for sound effects.
- **ARP** - Used for programs with the arpeggiator active.
- **SEQ** - Used for programs with sequencing.
- **PERC** - Used for percussion sounds.
- **AMBIENT** - Used for ambient or texture sounds.
- **MODULAR** - Used for programs with modular type programming.
- **USER-1/4** - Used for user/project specific sounds..

For information on how to assign a category, please consult the section on writing programs.

## 4.4 Browsing by Category

To access the program browser, press and hold the PROG switch.



**Note:** a help menu will appear while the PROG switch is held, showing additional guidance and commands:



To change programs, while you have the PROG switch held you can press the LEFT/RIGHT switches to select the PREVIOUS/NEXT programs within the category.

To change categories, while you have the PROG switch held you can press the UP/DOWN switches to select the PREVIOUS/NEXT category.

**Note:** While the PROG switch is held you can still see the category changes displayed behind the pop-up menu.

## 4.5 Default Program

In order to return to a fixed point when creating programs you recall a default program using the short-cut described here. The default program is configured without modulation/effects and uses basic settings in each of the sections.

To load the default program, press and hold the PROG switch, then press the COMPARE switch.



**Note:** a help menu will appear while the PROG switch is held, showing additional guidance and commands. The default program will then be loaded.

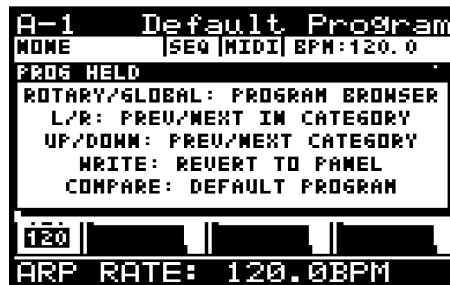

## 4.6 Revert to Panel

When you load a program, all the physical controls on the DeepMind 12 may not match the position stored in memory. In order to send all the physical positions to the program (rather than moving each individually until you reach the stored value), follow the procedure below:

**Warning:** When you do this the sound/character of the program will often change radically as the multiple parameters are updated.

To revert to the panel controls, press and hold the PROG switch, then press the WRITE switch.



**Note:** a help menu will appear while the PROG switch is held, showing additional guidance and commands:

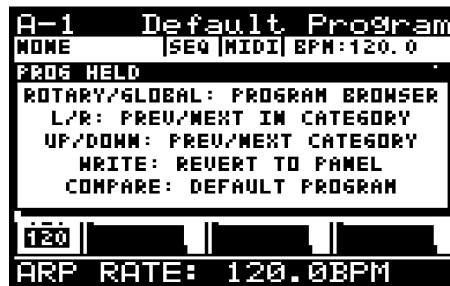

The current program will then be updated with the positions of the physical controls on the DeepMind 12.

## 4.7 Restoring Program Data

If you edit a program and forget to write it before selecting a new program - don't panic - a backup of the program is stored in memory. Whenever this happens a pop-up menu will appear with a message saying "Press COMPARE to restore edits":



By pressing the COMPARE switch your previously editing patch will be re-instated.

You will then see another pop-up message reminding you to press WRITE to store your edits:



## 4.8 Writing Programs

To write a program to memory press the WRITE switch to open the WRITE PROGRAM menu.



The WRITE PROGRAM menu will then appear:

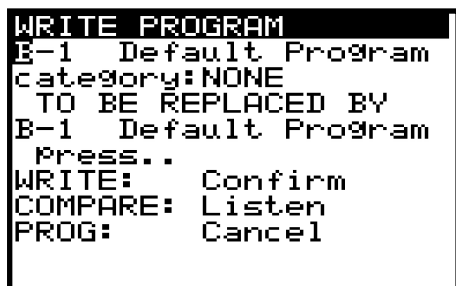

In this menu you can use the -NO/+YES switches to navigate through the sections. The selected section will be highlighted by an inverted character (white on black).

The first section is the program location the current program will be saved. You can use the UP/DOWN switches, the rotary knob, or the fader to select the required BANK (A-H) and PROGRAM NUMBER (1-128).

The second section is the CATEGORY to select any of the available categories. Again you can use the UP/DOWN switches, the rotary knob, or the fader to select the required CATEGORY.

The third section is REPLACED BY which allows you to name the program to be written. You can use the -NO/+YES switches to step through each character of the name and use the UP/DOWN switches, the rotary knob, or the faders to change the character.

There are also two short-cuts for selecting characters indicated by text above the FX and GLOBAL switches:



**a-A-0** - Pressing the FX switch will cycle between lower-case, upper-case and numbers.

**DEL** - Pressing the GLOBAL switch will delete the currently selected character.

**Note:** These short-cuts only appear when you are editing the name of the REPLACED BY program.

To compare the current program with the intended program location you can press the COMPARE switch to listen to the difference. To return to the current program, press the compare switch again.



Once you have selected the new location and named the program simply press the WRITE switch again to write the program.

At anytime you decide you do not want to write the program, you can press the PROG switch to return to the main programming display.

**Note:** If there is a program in the backup memory then you will see the message "COMPARE to clear backup".

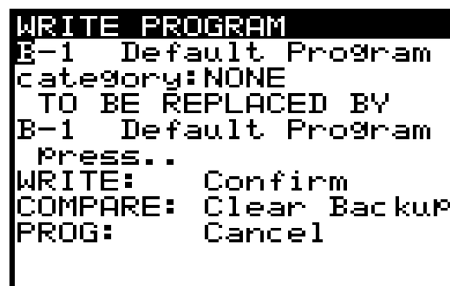

If you wish to listen to the intended program location as described earlier you will need to press the COMPARE switch to clear the backup memory. Once the backup has been cleared then the message will revert to "COMPARE to listen" and you can listen to the intended program location as normal.

## 4.9 Re-naming Programs

To rename a program simply follow the procedure for writing a program and keep the BANK and PROGRAM NUMBER the same.

### 4.10 The COMPARE function

The COMPARE feature has two main functions:

Firstly you can use it to COMPARE the current (edited) program with the original program.

Secondly you can use it to COMPARE and/or match the current position of the physical faders on the surface with the original program. This is necessary when you wish to maintain the sound/character of the program.

To perform both functions simply press the COMPARE switch.



**Note:** If you have not edited the program (i.e. changed some parameters) when you press the COMPARE switch you will restore the backup as described in a previous chapter.

Firstly the sound/character will return to its original state so that you can compare your edits.

**Note:** If you do not want to match the fader positions you can simply press COMPARE again to return to programming.

Secondly, you now have the option to match the position of the physical faders to the positions stored in the original program.

You will then see a page of the COMPARE menu (page 1 is displayed below). The page shown will be the last page you used. If you have never used the COMPARE function since turning the DeepMind 12 on, it will default to page 1.



Each page of the COMPARE menu shows a section of the faders.

If the position of the fader matches the position of the stored value the fader will be black.

If the fader does not match the position it will be white with a superimposed arrow pointing in the direction it needs to move in order to approach the stored value.

There is also a white bar to show how far the fader needs to move in order to match the stored value.

Once the fader reaches the stored position it will turn black to indicate it is now matched.

**Note:** The pages will switch automatically when you begin to adjust any of the faders.

There are four pages of faders in the COMPARE menu, to access the other pages use the +/- switches to select the previous/next pages.

Page 1 Shows the ARP/SEQ and LFO faders:

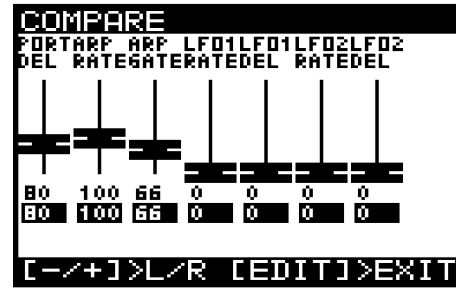

Page 2 shows the OSC faders:



Page 3 shows the UNISON, VCF, HPF and VCA faders:

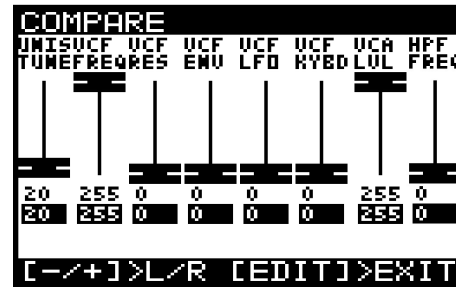

Page 4 shows the ENVELOPE faders:

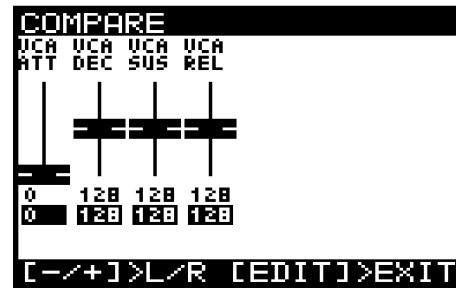

**Note:** You can still select specific envelopes to match the faders depending on your requirements.

## 5. Playing Guide

This section describes the use of the DeepMind 12 for playing and performance. It covers all the main aspects of the synthesizer.

There are 64 physical controls on the DeepMind 12 made up of illuminated switches, faders, rotary knobs and wheels.

There are also many virtual controls/parameters and menu based controls within the software, please consult the section on programming for detailed information.

### 5.1 Display

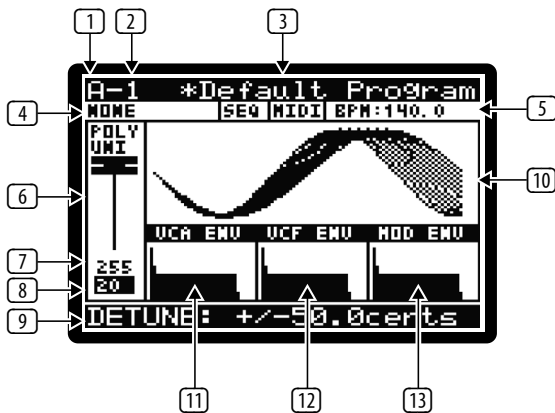

The PROG (Programming) page is the main display of the synthesizer.

During playing the display can show the status of the synthesizer when the PROG switch is pressed. The PROG switch will be illuminated when you are in this mode.

Being able to see all this information on one screen allows you to quickly check any of the following parameters shown on the display:

- ① PROGRAM BANK ("A" in the example above).
- ② PROGRAM NUMBER ("1" in the example above).
- ③ PROGRAM NAME ("Default Program" in the example above).
- ④ PROGRAM CATEGORY ("NONE" in the example above).
- ⑤ SEQ STATUS / MASTER BPM EXTERNAL / BPM ("OFF", "MIDI", "140.0" in the example above).
- ⑥ PARAMETER CONTROL ("POLY UNI" in the example above).
- ⑦ CURRENT PARAMETER MIDI VALUE (255 in the example above).
- ⑧ STORED PARAMETER VALUE (20 in the example above).
- ⑨ CURRENT PARAMETER EXPLICIT NAME/VALUE ("DETUNE +/-50.0cents" in the example above).
- ⑩ PARAMETER VISUALIZATION (the UNISON waveform in the example above).
- ⑪ VCA ENV VISUALIZATION (VCA ENV in the example above).
- ⑫ VCF ENV VISUALIZATION (VCF ENV in the example above).
- ⑬ MOD ENV VISUALIZATION (MOD ENV in the example above).

**Note:** The brightness and contrast of the display can be adjusted in the GLOBAL-PANEL SETTINGS menu.

For more detail on the PROG screen and the status of the synthesiser, please consult the programming section later in this manual.

### 5.2 Keyboard (Velocity/Aftertouch)

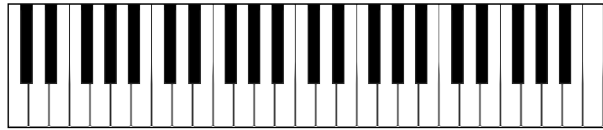

The DeepMind 12 has 49 semi-weighted full-size keys featuring expressive velocity and after-touch.

The keyboard spans four octaves with the ability to shift octaves up or down to meet your playing requirements.

The aftertouch and velocity expression can have individual curves applied to their response in order to fine tune your playing style/requirements.

The velocity is expressive in two ways:

The (NOTE) ON VELOCITY - i.e. The velocity that you strike the keys.

The (NOTE) OFF VELOCITY - i.e. The velocity that you release the keys.

The ON/OFF velocities can be set to a fixed value if required which will override the velocity of the strike and release values.

**Note:** The settings to adjust the response curves and fixed values can be found in the GLOBAL-KEYBOARD SETTINGS menu.

**Note:** You can also turn off the keyboard's LOCAL messages allowing you to play an external device, without affecting the DeepMind 12.

### 5.3 Pitch Bend and Modulation Wheels

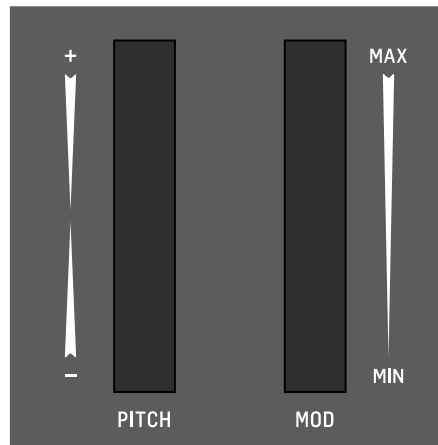

**PITCH WHEEL** - The pitch wheel allows you to lower or raise the pitch of the notes being played expressively.

The range of the PITCH BEND can be assigned in the second page of the POLY menu (accessed by pressing the POLY switch twice).

The pitch wheel is spring loaded and will naturally return to its centre point after you adjust it and release the wheel.

**MODULATION WHEEL** - The modulation wheel allows you to apply any type of modulation or expression to a single (or multiple) parameters.

For traditional playing this can be used to create vibrato, or in a more creative way e.g. to open the filter by assigning to the VCF FREQUENCY.

The wheels are illuminated so that they can be seen even in low light conditions. They can be fixed on, turned off or placed in AUTO mode which will increase the LED intensity as the wheel is moved.

For more detail on controlling advanced parameters relating to the PITCH WHEEL and the MODULATION WHEEL please consult the section later in this manual.

## 5.4 Octave Shift (OCT UP/DOWN)



These switches allow you to raise or lower the keyboard's pitch range in steps of one octave.

The LEDs above the switches labelled OCTAVE will show the current octave shift applied to the keyboard.

Pressing both switches together will reset to Octave 0 (no transpose).

## 5.5 Voice Indication

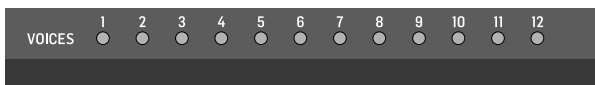

The DeepMind 12 has 12 independent voices. There are 12 LEDs above the keyboard showing the status of each voice.

When playing in traditional POLY mode the voice LEDs will light individually using the full polyphonic capabilities.

When playing in any of the UNISON or MONO modes the voice LEDs will light simultaneously depending on the number of voices allocated.

**Note:** The settings to adjust the polyphony and voice allocation can be found in the POLY-VOICE PARAMETERS menu.

## 5.6 Portamento



The PORTAMENTO function makes the pitch of a note glide up or down from the previously played note. The PORTAMENTO knob controls the time taken to transition from the previous note to the currently played note.

The knob ranges from 0 seconds (instant change of note, with no pitch gliding) to 10 seconds.

The PORTAMENTO function can be tuned to your specific playing requirements by way of 14 different modes.

The PORTAMENTO function can also be balanced between the OSCs, allowing you to set the ratio of PORTAMENTO applied to OSC 1 and OSC 2.

For more detail on controlling advanced parameters relating to PORTAMENTO please consult the section later in this manual.

## 5.7 Volume



The volume knob controls the output level for both the main outputs and the headphones simultaneously. If you find the need to compensate the main output level, please do so using your gain stage on your mixer, audio interface or amplifier.

## 5.8 Pedal Input (Rear Panel)

The pedal input is a ¼" TRS jack that allows you to connect an expression pedal.

The pedal input can be assigned to operate in one of five modes: FOOT CONTROL, MOD WHEEL, BREATH, VOLUME or EXPRESSION.

The operation of this pedal can be customized using the GLOBAL / PEDAL SETTINGS menu.

For more detail on controlling advanced parameters relating to the pedal input please consult the section later in this manual.

## 5.9 Sustain Input (Rear Panel)

The sustain input is a ¼" TS jack that allows you to connect a sustain pedal, such as a normally-open switch.

The sustain input can be assigned to operate in one of several modes. For more information please consult the PEDAL SETTINGS section later in this document.

The operation of this pedal can be customized using the GLOBAL / PEDAL SETTINGS menu.

For more detail on controlling advanced parameters relating to the sustain input please consult the section later in this manual.

## 5.10 Slide Fader Operation Modes

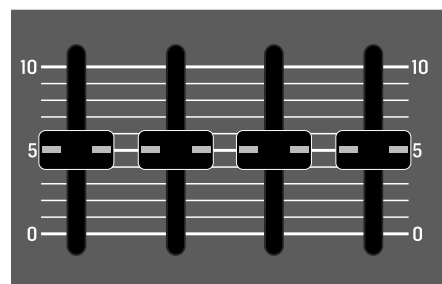

The slide faders can operate in two modes: PASS-THRU or JUMP.

For more detail on controlling the way the slide faders respond when adjusted, please consult the section later in this manual.

**Note:** You can also turn off the faders LOCAL messages allowing you to control an external device, without affecting the DeepMind 12.



## 6. Signal Path / Voice Structure

The signal path / voice structure from the OSCs to the main outputs is completely analog. The DSP effects can be bypassed completely to maintain the analog path. When routed through the DSP effects all sampling is done at 24-Bit 48 kHz. All internal DSP effects are processed at 32/40-Bit floating point resolution.

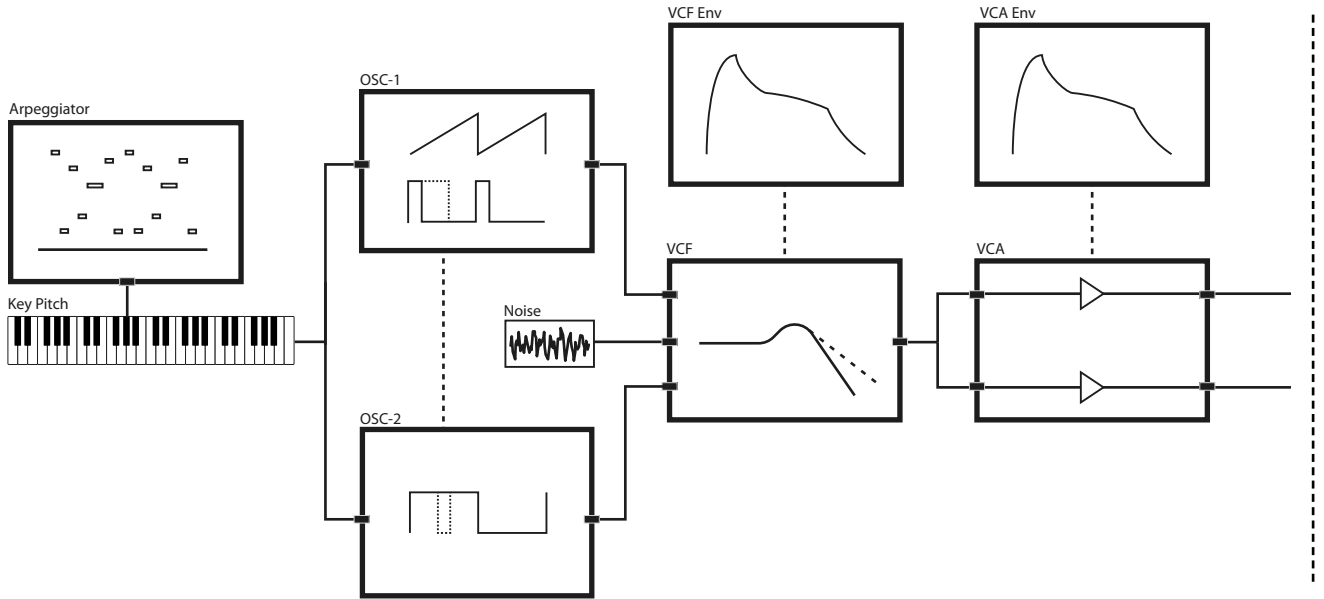

MODE	ANALOG PATH	DIGITAL PATH
INSERT	OFF	ON
SEND	ON	ON
BYPASS	ON	OFF

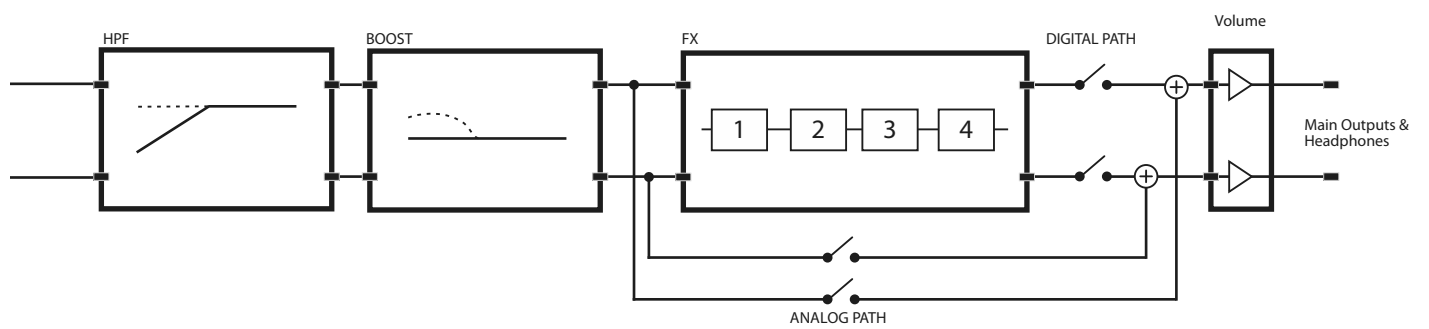

# EN Mod Matrix

The Modulation Matrix is a large scale digital routing matrix which allows a massive number of potential modulations. The matrix configuration is stored and recalled with the program data.

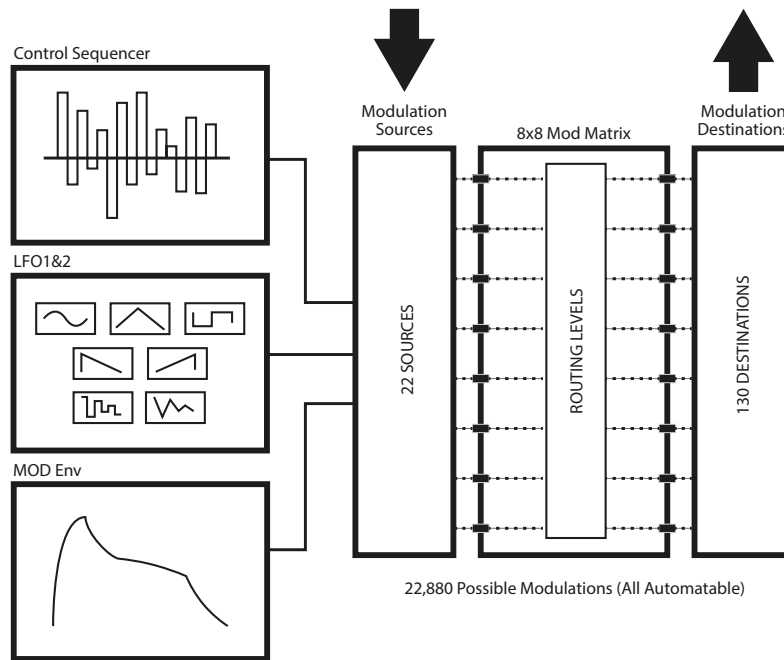

## MIDI Routing

The DeepMind 12 offers extreme MIDI routing possibilities, allowing you to integrate the synthesizer with many different pieces of hardware and software.

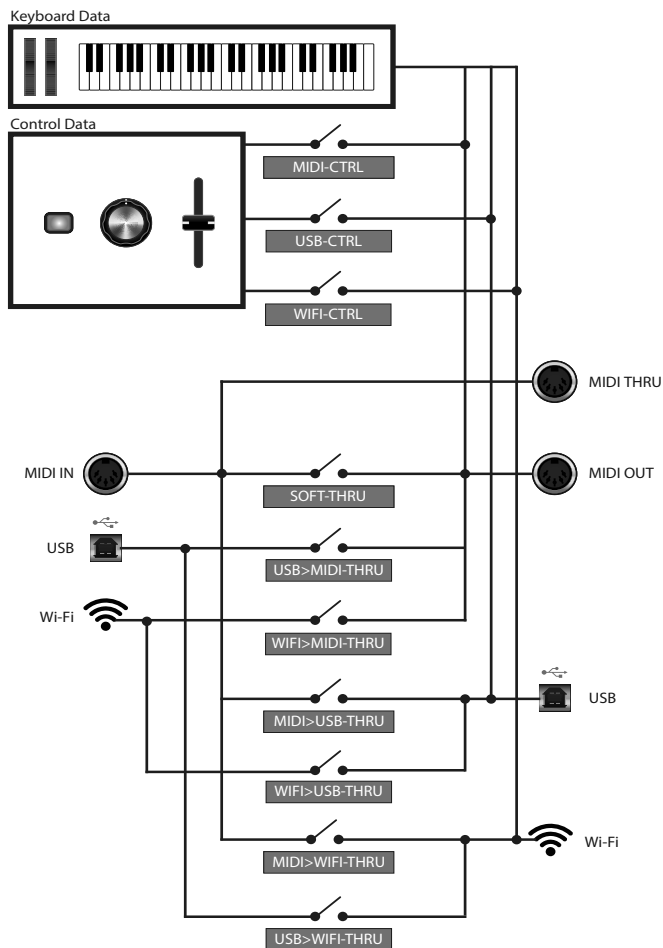

## 7. Menu System

The DeepMind 12 Display allows you to access the detailed parameters, controls, options and features of the synthesizer.

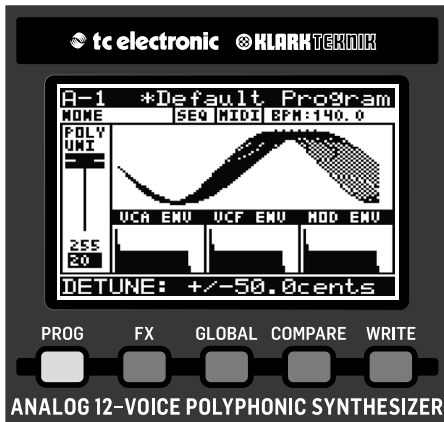

Navigating the MENU system can be done by pressing the top level menu switches PROG, FX, GLOBAL, COMPARE and WRITE.

**Note:** The FX and GLOBAL menus have several pages, to access successive pages simply press the same switch again to cycle through the pages.

**Note:** The DeepMind 12 will always return you to the last page within a menu that was accessed. This way you can return to your last change without needing to cycle through the previous pages. Note: You can change this functionality using the REMEMBER PAGES option in the GLOBAL SETTINGS.

### 7.1 PROG (Programming Menu)

To access the PROG menu, press the PROG switch, the PROG switch will remain illuminated while you are in this menu.



The PROG (Programming) menu will then be shown:

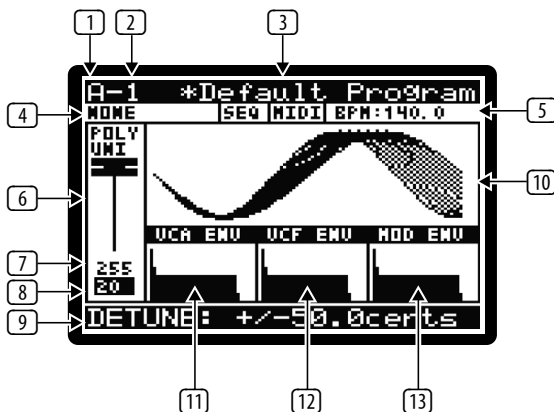

The PROG (Programming) page is the main display of the synthesizer.

During playing the display can show the status of the synthesizer when the PROG switch is pressed.

Being able to see all this information on one screen allows you to quickly check any of the following parameters shown on the display:

#### 7.1.1 PROGRAM BANK

① ("A" in the example diagram) - There are 8 BANKS of PROGRAMS, each BANK contains 128 program locations. The DeepMind 12 comes pre-loaded with 1024 programs from leading synthesizer programmers from around the world.

#### 7.1.2 PROGRAM NUMBER

② ("1" in the example diagram) - There are 128 PROGRAMS in each BANK.

#### 7.1.3 PROGRAM NAME

③ ("Default Program" in the example diagram) - The PROGRAM name can use up to 16 characters, including uppercase, lowercase, numbers and symbols.

**Note:** When you see the '\*' symbol at the start of a PROGRAM name this indicates that the PROGRAM has been edited/changed from its stored state.

Once you complete your editing and WRITE the program, the '\*' symbol will no longer be shown.

#### 7.1.4 PROGRAM CATEGORY

④ ("NONE" in the example diagram) - Each PROGRAM can be assigned to one of 17 categories. By assigning a category to a PROGRAM, it helps browsing for a particular type of sound much easier.

The available categories are listed here:

- **NONE** - No category information is stored.
- **BASS** - Used for bass sounds.
- **PAD** - Used for pad sounds.
- **LEAD** - Used for lead sounds.
- **MONO** - Used for monophonic sounds.
- **POLY** - Used for polyphonic sounds.
- **STAB** - Used for stab sounds.
- **SFX** - Used for sound effects.
- **ARP** - Used for programs with the arpeggiator active.
- **SEQ** - Used for programs with sequencing.
- **PERC** - Used for percussion sounds.
- **AMBIENT** - Used for ambient or texture sounds.
- **MODULAR** - Used for programs with modular type programming.
- **USER-1** - Used for user/project specific sounds.
- **USER-2** - Used for user/project specific sounds.
- **USER-3** - Used for user/project specific sounds.
- **USER-4** - Used for user/project specific sounds.

For information on how to assign a category, please consult the section on writing programs.

### 7.1.5 SEQ STATUS, MIDI SYNC SOURCE, BPM VALUE

- 5 It is important to note that on this line there are three separate pieces of information:
- **SEQ STATUS** ("SEQ" in the example diagram) - This shows the status of the CONTROL SEQUENCER. If the letters SEQ are inverted (white on a black background) then the CONTROL SEQUENCER is ON. If the letters SEQ appear as normal text the CONTROL SEQUENCER is OFF. Note: The CONTROL SEQUENCER ON/OFF control can only be adjusted from the CONTROL SEQUENCER MENU described later in this document.
  - **MASTER BPM SOURCE** ("MIDI" in the example diagram) - The Master BPM can be generated internally (shown as "INT"), or the DeepMind 12 can synchronize to an incoming MIDI clock signal from the MIDI IN socket (shown as "MIDI"), or USB ports (shown as "USB"). If the letters are inverted (white on a black background) then the clock is synchronised to the external source. If the letters appear as normal text the external source is not present and the DeepMind 12 will use its internal Master BPM until the external source is present. Note: The settings for the MIDI SYNC can be found in the EDIT page of the ARPEGGIATOR described later in this document.
  - **BPM VALUE** ("BPM:120.0" in the example diagram) - The Arpeggiator, Control Sequencer and Patterns use a system wide Master BPM (Beats Per Minute) Clock. The BPM is shown and will auto update if using an external synchronisation source.

### 7.1.6 PARAMETER CONTROL

- 6 ("POLY UNI" in the example diagram) - This is a fader representation of the parameter which is currently being adjusted (or was last adjusted). The name of the parameter is also shown:

If the position of the fader matches the position of the stored value the fader will be black.

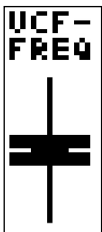

If the fader does not match the position it will be white with a superimposed arrow pointing in the direction it needs to move in order to approach the stored value.

When the fader does not match the position there is also a white bar to show how far the fader needs to move in order to match the stored value.

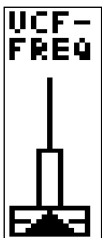

**Note:** If the physical fader position is close to the stored value the white bar can be obscured by the fader.

### 7.1.7 CURRENT PARAMETER MIDI VALUE

- 7 (255 in the example diagram) - This is the value of the parameter which is currently being adjusted (or was last adjusted).

**Note:** The parameter is displayed here as a simple value (0-255) which allows you to quickly compare current and stored values. For explicit values please see the area at the bottom of the page discussed later in this chapter.

### 7.1.8 STORED PARAMETER VALUE

- 8 (20 in the example diagram) - This is the stored value of the parameter which is currently being adjusted (or was last adjusted).

The stored parameter is shown in reverse text (i.e. white on a black background)

### 7.1.9 CURRENT PARAMETER NAME/VALUE

- 9 ("DETUNE +/-50.0cents" in the example diagram) - In this area you will see more detailed information on the parameter being adjusted.

The enhanced information contains:

- A more detailed description of the parameter being adjusted.
- A more accurate value of the parameter being adjusted.
- The type of units used for the value (cents in the example above, but could be Hz for frequency etc.).

### 7.1.10 PARAMETER VISUALIZATION

- 10 (The UNISON waveform in the example diagram) - This area shows a visualization of the parameter being adjusted (or last adjusted).

These visualizations are designed to:

- Help anyone with limited experience to achieve a deeper understanding of each of the parameters while learning the synthesizer.
- Help the experienced player/sound designer/programmer to work quickly and get visual confirmation about the adjustment being made.

### 7.1.11 VCA ENV VISUALIZATION

- 11 (VCA ENV in the example diagram) - This area shows a visualization of the VCA envelope. The full Attack, Decay, Sustain, Release and their respective curves are represented.

### 7.1.12 VCF ENV VISUALIZATION

- 12 (VCF ENV in the example diagram) - This area shows a visualization of the VCF envelope. The full Attack, Decay, Sustain, Release and their respective curves are represented.

### 7.1.13 MOD ENV VISUALIZATION

- 13 (MOD ENV in the example diagram) - This area shows a visualization of the MOD envelope. The full Attack, Decay, Sustain, Release and their respective curves are represented.

## 7.2 FX (Effects Menu)

The on-board virtual FX Rack provides access to four true-stereo, multi-effects processors including delay, chorus, dynamics and production-quality true-stereo reverbs.

You can select any combination of high-end simulations of legendary studio effects.

### 7.2.1 FX OVERVIEW

To access the FX menu simply press the FX switch; the FX switch will be illuminated when you are in this menu.



The display will then show the FX OVERVIEW menu:

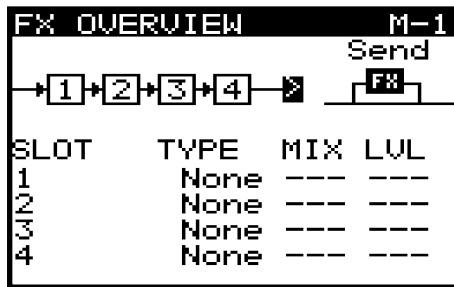

To navigate within the FX OVERVIEW menu, navigate within the display menus using the UP, DOWN, +/YES & -/NO switches.

Selected parameters on the display are adjusted using the rotary knob or the fader. The rotary knob has a click which allows very accurate control. The fader allows rapid adjustment across the full range.

The options available in the FX OVERVIEW menu are as follows:

**FX ROUTING** - At the top of the FX OVERVIEW menu you will see the FX ROUTING shown as a series of 4 boxes representing the individual effects.

In order to expand the sonic possibilities of the DSP FX inside the DeepMind 12 there are several routing options for the four slots.

**Warning:** The routings with feedback are highly creative, but as they employ feedback loops, careful consideration should be made while using them. It is recommended to keep the VOLUME knob in a low position while experimenting.

**FX MODE** - This allows you to choose if the effects are to be configured in INSERT MODE, SEND (and Return) MODE, or to BYPASS the effects.

**FX SLOTS** - These are the four slots you can load effects modules into.

**MIX** - The MIX parameter controls how much of the original sound is blended with the effected/processed sound for each FX slot.

**LEVEL** - The LEVEL parameter controls the output level of any effects which are configured in parallel, or any effects which are the last effect before reaching the output stage.

To exit the FX menu press the PROG switch to return to the main programming screen.

**Note:** To reduce the possibility of excessive low frequency build up there is a 30 Hz High Pass Filter used in the feedback path for routing options which include feedback.

### 7.2.2 SELECTING FX ROUTING

To select a routing make sure that the '<' symbol is highlighted next to the routing diagram, then you can either turn the rotary knob, or use the data entry fader to select from one of the following routings:

#### SERIAL 1-2-3-4 (M-1)

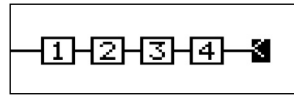

#### PARALLEL 1/2 SERIAL 3-4 (M-2)

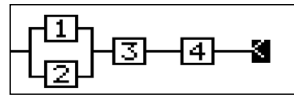

#### PARALLEL 1/2 PARALLEL 3/4 (M-3)

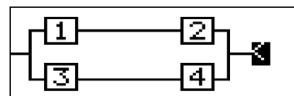

#### PARALLEL 1/2/3/4 (M-4)

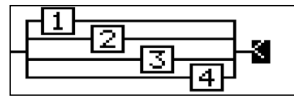

#### PARALLEL 1/2/3 SERIAL 4 (M-5)

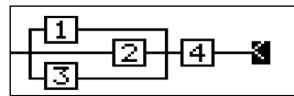

#### SERIAL 1-2 PARALLEL 3/4 (M-6)

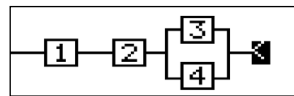

#### SERIAL 1 PARALLEL 2/3/4 (M-7)

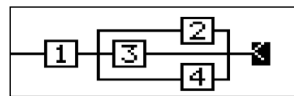

#### PARALLEL (SERIAL 1-2-3)/4 (M-8)

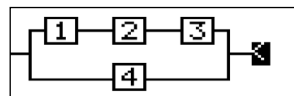

#### SERIAL 3-4 FEEDBACK4(1-2) (M-9)

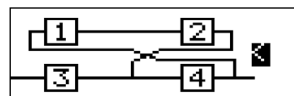

#### SERIAL 4 FEEDBACK4(1-2-3) (M-10)

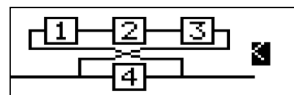

### 7.2.3 SELECTING FX MODE

To select an effects MODE make sure that the '<' symbol is highlighted next to the effects MODE symbol, then you can either turn the rotary knob, or use the data entry fader to select from one of the following routings.

**INSERT** - In this configuration the effects slots are placed as INSERT effects into the signal flow of the synthesizer outputs.



**SEND** - In this configuration the synthesizer output signals are SENT to the effects slots and the returned into the signal flow of the synthesizer outputs.



**BYPASS** - In this configuration the effects are bypassed.



### 7.2.4 SELECTING FX

To load an effect into a slot, make sure that the '<' symbol is highlighted next to the slot you wish to use. Then you can either turn the rotary knob, or use the data entry fader to select from one of the following effects:

No	Name	Type
1	TC-DeepVRB	Reverb
2	Ambience	Reverb
3	Room Rev	Reverb
4	VintageRev	Reverb
5	Hall Rev	Reverb
6	Chamber Rev	Reverb
7	Plate Rev	Reverb
8	Rich Plate	Reverb
9	Gated Rev	Reverb
10	Reverse	Reverb
11	ChorusVerb	Reverb
12	DelayVerb	Reverb
13	FlangeVerb	Reverb
14	4Band EQ	Processing
15	Enhancer	Processing
16	FairComp	Processing
17	MulBndDist	Processing
18	RackAmp	Processing
19	EdisonEX1	Processing
20	Auto-Pan	Processing
21	NoiseGate	Processing
22	Delay	Delay
23	3TapDelay	Delay
24	4TapDelay	Delay
25	T-RayDelay	Delay
26	DecimDelay	Delay
27	ModDlyRev	Delay
28	Chorus	Creative
29	Chorus-D	Creative
30	Flanger	Creative
31	Phaser	Creative
32	MoodFilter	Creative
33	Dual Pitch	Creative
34	RotarySpkr	Creative

When you stop on an effect it is automatically loaded into the chosen slot.

**Warning:** If you have made edits to any of the parameters within an effect you will be shown a pop-up warning dialog (unless dialogs are disabled in the GLOBAL MENU):

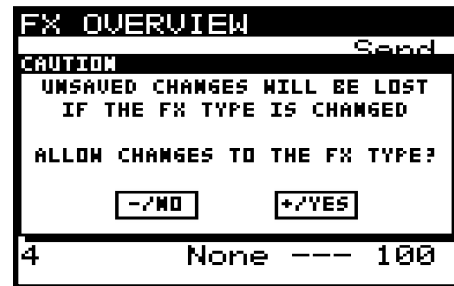

If you need to save your changes, press the -NO switch and then WRITE the PROGRAM as described in the chapter on writing programs.

If you don't need to save your changes, press the +/YES switch and continue selecting a new effect.

### 7.2.5 CONTROLLING MIX / LEVEL

To adjust the MIX parameters make sure that the '<' symbol is highlighted next to the word MIX on the effect slot you want to adjust. Then you can either turn the rotary knob, or use the data entry fader to change the value.

### 7.2.6 CONTROLLING LEVEL

To adjust the LEVEL parameters make sure that the '<' symbol is highlighted next to the word LEVEL on the effect slot you want to adjust. Then you can either turn the rotary knob, or use the data entry fader to change the value.

**Note:** Not all effects have a MIX parameter as it is only used on effects which are marked as "Processing" types in the Effects List. Also, be aware that the MIX parameter seen on the FX OVERVIEW and the MIX parameter in the FX editing pages are the same parameter and are shown in both pages for convenience.

If either the MIX or LEVEL parameter is not available you will see the "--" symbols in the FX OVERVIEW screen.

### 7.2.7 FX PAGES 1-4

Each of the effects pages show individual controls for each effect slot. There are up to 12 parameters per slot, depending on the effect which is loaded.

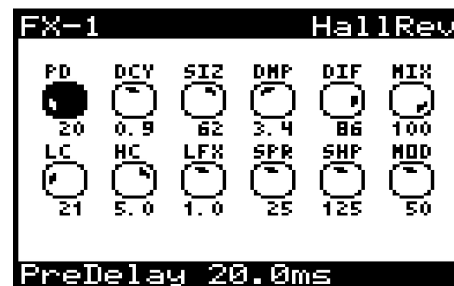

**Note:** To access successive FX pages simply press the same switch again to cycle through the pages.

### 7.2.8 ADJUSTING EFFECTS PARAMETERS

To navigate to the parameter you wish to adjust, use the UP/DOWN/+/- switches. The selected parameter will be highlighted in black and its detail shown on the bottom of the screen. To adjust a parameter you can either turn the rotary knob, or use the data entry slider.

**Note:** For detailed information on all effects and their parameters please consult the EFFECTS LIBRARY section later in this document.

### 7.2.9 COPY/PASTE FX SETTINGS

If you need to copy effects settings from a previously stored effect, please follow this procedure.

- 1) Ensure you have saved any edits you have made to your current program if required.
- 2) Load the program which has the effects settings you intend to copy.
- 3) Navigate to the 1, 2, 3, 4 flow diagram near the top of the FX screen.
- 4) Press the FX switch to enter the FX page.
- 5) Press and hold the FX switch until you see the following message and the GLOBAL/WRITE switches are flashing:

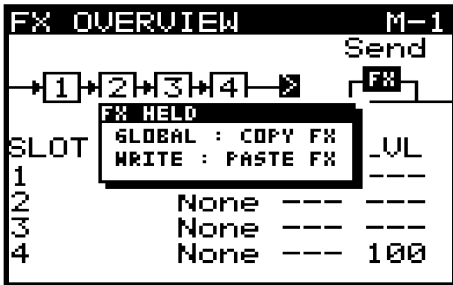

- 6) While continuing to hold the FX switch, press the GLOBAL switch to copy the effects settings into memory.
- 7) Then load the program you intend to paste the effects settings to.
- 8) Press the FX switch to enter the FX page.
- 9) Press and hold the FX switch until you see the following message:

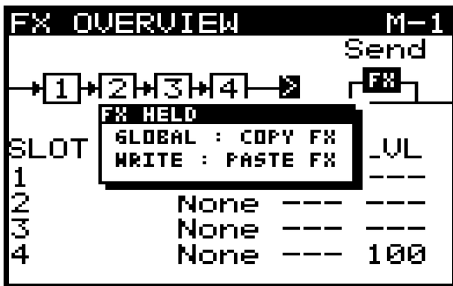

- 10) While continuing to hold the FX switch, press the WRITE switch to copy the effects settings from memory into the program.

**Note:** All settings relating to effects will be copied/pasted, these include FX routing, FX modes and all of the FX slots and their settings.

### 7.2.10 MOVING EFFECTS

If you need to move an effect to a different slot, please follow this procedure.

- 1) Ensure you have saved any edits you have made to your current program if required.
- 2) Press the FX switch to enter the FX page.
- 3) Navigate to the effects slot you wish to move.
- 4) Press and hold the FX switch until you see the following message and the BANK UP/DOWN switches begin flashing:

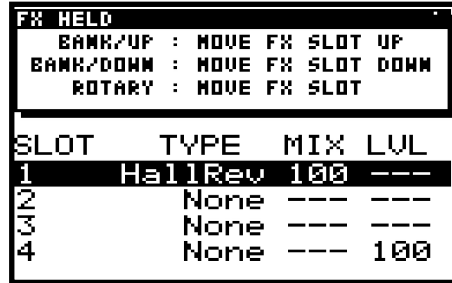

- 5) While continuing to hold the FX switch, you can move the effects slot to another location using one of these methods:
  - To move the slot to an adjacent upper slot press the BANK/UP switch.
  - To move the slot to an adjacent lower slot press the BANK/DOWN switch.
  - To move the slot to any other slot, turn the rotary knob.

You can continue to move the slot with any of the methods above, the new slot will be highlighted as shown below:

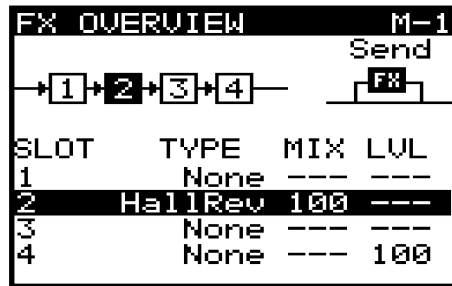

- 6) Once you release the FX switch the effect will be moved to the new slot.

**Note:** All effects parameters will be moved with the effect.

## GLOBAL (Global Menu)

Within the GLOBAL menu there are five pages:

- **CONNECTIVITY** - All settings relating to connectivity and communication with external devices including backup and restore functions.
- **KEYBOARD SETTINGS** - All settings relating to the keyboard including aftertouch and velocity.
- **PEDAL SETTINGS** - All settings relating to the pedal inputs.
- **PANEL SETTINGS** - All settings relating to panel (local), faders, dialogs, menu functionality, and display brightness and contrast.
- **SYSTEM SETTINGS** - All system settings, including versions, fan speed, calibration, and backup.

This chapter covers each of the pages in detail.

**Note:** To access successive GLOBAL pages simply press the GLOBAL switch again to cycle through the pages. There is a help message on the bottom of each screen to show you what the next menu will be if you press the GLOBAL switch again.

To access the GLOBAL menu simply press the GLOBAL switch, the switch will remain illuminated while you are in this menu:



The display will then show the GLOBAL menu.

**Note:** The first time you access the GLOBAL menu after turning on the DeepMind 12, you will see the CONNECTIVITY page. Whenever you access the GLOBAL menu after that point, you will be returned to the last page you visited within the menu system. This feature is reset when the unit is powered off.

**Note:** The page location memory function can be turned off using the REMEMBER PAGES function in the PANEL SETTINGS menu.

### 7.2.11 CONNECTIVITY



In this menu there are all the settings relating to connectivity and communication with external devices including backing up and restoring programs and data.

To navigate the options in the CONNECTIVITY menu, use the UP, DOWN, switches.

Selected parameters are adjusted using the -NO/+YES switches, the rotary knob or the fader. The rotary knob has a click which allows very accurate control. The fader allows rapid adjustment across the full range.

**DEVICE ID** - This is MIDI Device Identifier (ID) which is used to identify the device. This is important when multiple devices are present in a system, and ensures that the device in question responds to the system exclusive messages which are solely for the device in question.

The DEVICE ID can be any number from 1-16.

To change the DEVICE ID, make sure that the '<' symbol next to the DEVICE ID number is highlighted. Then you can either turn the rotary knob, or use the data entry slider.

**MIDI SETTINGS MENU** - This menu contains settings for the MIDI sockets on the rear of the DeepMind 12.

To access the MIDI SETTINGS menu, make sure that the '<' symbol on the MIDI SETTINGS line is highlighted. Then press the +/YES switch, you will now see the MIDI SETTINGS menu.



- **MIDI-CTRL** - This option sets the MIDI CONTROLLER communication mode for the DeepMind 12 MIDI sockets on the rear of the synthesizer. You can choose Off (No controller messages will be sent), Cc (Continuous Controller) or NRPN (Non-Registered Parameters).

**Note:** Both MIDI and NRPN data is always received and actioned.

**Note:** For more information on controlling the DeepMind 12 via MIDI, please consult the section on MIDI later in this document.

- **PROG-CHANGE** - This option sets the PROGRAM CHANGE communication mode for the DeepMind 12 MIDI sockets. You can choose from the following options:

**RX** - Program change messages will be received only.

**TX** - Program changes will be transmitted only.

**RX-TX** - Program changes will be transmitted and received.

**NONE** - No program change messages will be sent or received.

- **RX-CHANNEL** - This option sets the MIDI channel that will be used to RECEIVE MIDI messages. The CHANNEL can be any number from 1-16.
- **TX CHANNEL** - This option sets the MIDI channel that will be used to TRANSMIT MIDI messages. The CHANNEL can be any number from 1-16
- **SOFT-THRU** - This option enables PASS-THRU mode from the MIDI INPUT socket to the MIDI OUTPUT socket. The options are On or Off.
- **MIDI>USB-THRU** - This option enables PASS-THRU mode from the MIDI INPUT socket to the USB host. The options are On or Off.
- **MIDI>WIFI-THRU** - This option enables PASS-THRU mode from the MIDI INPUT socket to the WIFI connection. The options are On or Off.

To exit this menu press the GLOBAL switch to return to the CONNECTIVITY menu.



**USB SETTINGS MENU**- This menu contains settings for the USB port on the rear of the DeepMind 12.

To access the USB SETTINGS menu, make sure that the '<' symbol on the USB SETTINGS line is highlighted. Then press the +/YES switch, you will now see the USB SETTINGS menu..

```
>>USB SETTINGS
USB-CTRL          Cc<
PROG-CHANGE      RX-TX
RX-CHANNEL       1
TX-CHANNEL       1
USB>MIDI-THRU    Off
USB>WIFI-THRU    Off

[GLOBAL]> BACK
```

- **USB-CTRL** - This option sets the MIDI CONTROLLER communication mode for the DeepMind 12 USB port on the rear of the synthesizer. You can choose **Off** (No controller messages will be sent), **Cc** (Continuous Controller) or **NRPN** (Non-Registered Parameters).

**Note:** Both MIDI and NRPN data is always received and actioned.

**Note:** For more information on controlling the DeepMind 12 via USB-MIDI, please consult the section on MIDI later in this document.

- **PROG-CHANGE** - This option sets the PROGRAM CHANGE communication mode for the DeepMind 12 USB host port. You can choose from the following options:

**RX** - Program change messages will be received only.

**TX** - Program changes will be transmitted only.

**RX-TX** - Program changes will be transmitted and received.

**NONE** - No program change messages will be sent or received.

- **RX-CHANNEL** - This option sets the MIDI channel that will be used to RECEIVE MIDI messages. The CHANNEL can be any number from 1-16.
- **TX CHANNEL** - This option sets the MIDI channel that will be used to TRANSMIT MIDI messages. The CHANNEL can be any number from 1-16.
- **USB>MIDI-THRU** - This option enables PASS-THRU mode from the USB port to the MIDI-THRU socket. The options are On or Off.
- **USB>WIFI-THRU** - This option enables PASS-THRU mode from the USB port to the WIFI host. The options are On or Off.

To exit this menu press the GLOBAL switch to return to the CONNECTIVITY menu.

**WIFI SETTINGS MENU**- This menu contains settings for the WIFI connection of the DeepMind 12.

To access the WIFI SETTINGS menu, make sure that the '<' symbol on the WIFI SETTINGS line is highlighted. Then press the +/YES switch, you will now see the WIFI SETTINGS menu

```
>>WIFI SETTINGS
WIFI-CTRL        Cc<
PROG-CHANGE      RX-TX
RX-CHANNEL       1
TX-CHANNEL       1
WIFI>MIDI THRU   Off
WIFI>USB THRU    Off

[GLOBAL]> BACK
```

- **WIFI-CTRL** - This option sets the MIDI CONTROLLER communication mode for the DeepMind 12 WIFI connection. You can choose **Off** (No controller messages will be sent), **Cc** (Continuous Controller) or **NRPN** (Non-Registered Parameters).

**Note:** Both MIDI and NRPN data is always received and actioned.

**Note:** For more information on controlling the DeepMind 12 via WIFI-MIDI please consult the section on MIDI later in this document.

- **PROG-CHANGE** - This option sets the PROGRAM CHANGE communication mode for the DeepMind 12 WIFI connection. You can choose from the following options:

**RX** - Program change messages will be received only.

**TX** - Program changes will be transmitted only.

**RX-TX** - Program changes will be transmitted and received.

**NONE** - No program change messages will be sent or received.

- **RX-CHANNEL** - This option sets the MIDI channel that will be used to RECEIVE MIDI messages. The CHANNEL can be any number from 1-16.
- **TX CHANNEL** - This option sets the MIDI channel that will be used to TRANSMIT MIDI messages. The CHANNEL can be any number from 1-16.
- **WIFI>MIDI-THRU** - This option enables PASS-THRU mode from the WIFI connection to the MIDI-THRU socket. The options are On or Off.
- **WIFI>USB-THRU** - This option enables PASS-THRU mode from the WIFI connection to the USB host. The options are On or Off.

To exit this menu press the GLOBAL switch to return to the CONNECTIVITY menu.

**NETWORK SETTINGS MENU**- This menu contains settings for the WiFi connection of the DeepMind 12.

The DeepMind 12 supports the Real-Time MIDI (RTP) protocol for use with network devices/applications.

To access the NETWORK SETTINGS menu, make sure that the '<' symbol on the NETWORK SETTINGS line is highlighted. Then press the +/YES switch, and you will now see the NETWORK SETTINGS menu:

```
>>NETWORK SETTINGS
MODE                               Off<
[GLOBAL]> BACK
```

There are three modes for the NETWORK connection:

- **Off** - Network connection is disabled.
- **Client** - This mode allows the DeepMind 12 to act as a client so that it can connect to an access point.
- **Access Point** (Software Enabled Access Point) - The DeepMind 12 can create an access point which will allow clients/devices to connect to it.

The default mode for the NETWORK connection is Off. This mode persists across power cycles.

**Client Mode** - When Client mode is selected, additional options are displayed:

```
>>NETWORK SETTINGS
MODE                               Client<
ENABLE                             Disconnected
SSID:                               MyHomeRouter
PASSWORD:                           MyPassword
IP                                  000.000.000.000
[GLOBAL]> BACK
```

To navigate the options in Client mode, use the UP and DOWN switches.

In order to change any of the parameters, make sure that the '<' symbol is on the respective line, and press the +/YES switch to edit.

- **ENABLE** - This shows the current state of the Client Mode connection - there are 4 states: Disconnected, Connecting, Connected, and Disconnecting. It is possible to initiate a connection using the YES switch, and cancel a connection using the NO switch.
- **SSID and Password** - These are the SSID and Password strings the DeepMind12 uses to connect to the desired network. Editing the values of these strings will bring up a text editing pop up dialog.

```
PASSWORD:
  PassPhrase
=>?@abcde fghijklmno
CANCEL DELETE CAPS INSERT OK
```

When editing any of the details, the dialog allows you to enter alphanumeric characters and also shows CANCEL, DELETE, CAPS LOCK and INSERT options. Once you have changed the details to your requirements, press the OK switch to confirm the settings.

- **IP** - Shows the IP address assigned to the DeepMind12 by the DHCP server running on the Access Point it is connected to.

**Access Point Mode** - When this mode is selected, additional options are displayed:

```
>>NETWORK SETTINGS
MODE                               Access Point<
ENABLE                             Disabled
SSID:                               DeepMind123
PASSWORD:                           PassPhrase
IP                                  192.168.012.001
CHANNEL                             1
[GLOBAL]> BACK
```

In Access Point mode, you will need to enter the details of the access point you wish to create.

To navigate the options in Access Point mode, use the UP and DOWN switches.

In order to change any of the parameters make sure that the '<' symbol is on the respective line, and press the +/YES switch to edit.

- **ENABLE** - This shows the current state of the Access Point connection - there are 7 states: Disabled, Enabling, Enabled, Disabling, Connecting, Connected, and Disconnecting. It is possible to enable the AP using the YES switch, and disable the AP using the NO switch. Once the AP is enabled, the connection status of any client that connects to the DeepMind12 will be shown as either Connecting, Connected, or Disconnecting. It is possible to reject a client that has already connected, by pressing NO.
- **SSID and Password** - These are the SSID and Password strings the DeepMind12 uses to create the Access Point network. Editing the values of these strings will bring up a text editing pop up dialog:

When editing any of the details, the dialog allows you to enter alphanumeric characters and also shows CANCEL, DELETE, CAPS LOCK and INSERT options. Once you have changed the details to your requirements, press the OK switch to confirm the settings.

```
PASSWORD:
  PassPhrase
=>?@abcde fghijklmno
CANCEL DELETE CAPS INSERT OK
```

- **IP** - Shows the IP address the DeepMind12 uses for the Access Point.
- **Channel** - This shows the Wireless channel used by the Access Point.

**SYSEX EXPORT MENU**- This menu contains settings for the EXPORT menu of the DeepMind 12.

**Note:** Backing up your data is an important factor when working with the DeepMind 12. It allows you to keep a safe copy of your programming, manage settings depending on your use, and share your work with others.

To access the SYSEX EXPORT menu, press the GLOBAL switch until the CONNECTIVITY menu appears. Make sure that the '<' symbol on the EXPORT line is highlighted. Then press the +/YES switch, you will now see the SYSEX EXPORT menu.

```
>>SYSEX EXPORT
DESTINATION      Midi<
DUMP-TYPE        Prog
DUMP-BANK        A
SOURCE           A-1 Defau
SYSEX-DUMP       -->

[GLOBAL]>BACK TO MENU
```

- **DESTINATION** - This option sets the communication mode for the DeepMind 12 SYSTEM EXCLUSIVE (SysEx) messages.
  - Midi** - SysEx messages will be transmitted from the MIDI sockets on the rear of the synthesizer.
  - USB** - SysEx messages will be transmitted to the USB host.
  - WiFi** - SysEx messages will be transmitted to the WiFi connection.
- **DUMP TYPE** - This option sets the type of data which be exported. You can choose from the following:
  - Prog** - A single PROGRAM.
  - Bank** - An entire BANK of 128 PROGRAMS.
  - EditProg** -The PROGRAM in the EDIT BUFFER, i.e. the program you are currently working on.
  - Glob** - The GLOBAL settings, useful if you need different settings depending on your location/activity/requirements).
  - UserPat** - Any one of the 32 USER PATTERNS from the Arpeggiator.
  - EditPat** -The current PATTERN stored in the EDIT BUFFER, i.e. the PATTERN which is assigned in the program you are currently working on.
  - AllPat** - All user PATTERNS.
  - All** - All Banks, Programs, Patterns, and Global Settings.
  - CalData** - The data from the calibration routine.
- **DUMP BANK** - You can select the appropriate BANK here, from one of the 8 available (A-H). This option is only available when exporting.
- **SOURCE** - You can select the appropriate PROGRAM or PATTERN here. This option is only available when exporting.
- **SYSEX DUMP (EXPORTING)** - Pressing the +/YES switch while this option is selected will initiate the EXPORT based on the selected options.

To exit this menu press the GLOBAL switch to return to the CONNECTIVITY menu.

To exit the CONNECTIVITY menu press the PROG switch to return to the main programming screen, or press GLOBAL to cycle to the KEYBOARD SETTINGS menu.

## 7.2.12 KEYBOARD SETTINGS

**Note:** To access successive GLOBAL pages just press the GLOBAL switch again to cycle through the pages.

In this menu there are all the settings relating to keyboard.

To navigate the options in the KEYBOARD SETTINGS menu, use the UP and DOWN, switches.

In order to change any of the parameters make sure that the '<' symbol on the respective line is highlighted.

Selected parameters are adjusted using the -NO/+YES switches, the rotary knob or the fader. The rotary knob has a click which allows very accurate control. The fader allows rapid adjustment across the full range.

```
>>KEYBOARD SETTINGS
LOCAL            On<
OCTAVE          0
FIXED-ON-VEL    Off
FIXED-OFF-VEL   Off
VEL-CURVE       Soft
AFT-CURVE       Soft
WHEEL-LEDS     Auto

[GL0B]>PEDAL SETTINGS
```

**LOCAL** - This option turns LOCAL CONTROL for the DeepMind 12 keyboard , aftertouch, pitch wheel and modulation wheel On and Off. It is sometimes useful to turn LOCAL CONTROL off when using the DeepMind 12 to control other hardware/software synthesizers, effects and/or applications.

**OCTAVE** - This option allow you to adjust the OCTAVE setting for the keyboard. The OCTAVE setting affects the whole keyboard.

The default setting is 0, which means if you play the lowest note it will be a C2.

The OCTAVE can be adjusted from -2 to +2, allowing you to use the 49 keys to access the full eight octaves (98 keys).

Please refer to Appendix 1 - Octave Shifting at the end of this document for a diagram.

**FIXED-ON-VEL** - This option fixes the NOTE ON VELOCITY at a set value, so that regardless of how hard you strike the note, the value will always be the same. The higher the value, the higher the volume of the note. The value can range from 0-127. When this option is set to Off, the NOTE ON VELOCITY will be dependant upon how hard you strike the note.

**Note:** The NOTE ON VELOCITY sensitivity can be adjusted in the VCA edit page. Please refer to the VCA section later in this document for more details.

**FIXED-OFF-VEL** - This option fixes the NOTE OFF VELOCITY at a set value, so that regardless of how fast you release the note, the value will always be the same. The higher the value, the higher the volume of the note. The value can range from 0-127. When this option is set to Off, the NOTE OFF VELOCITY will be dependant upon how fast you release the note.

**Note:** The NOTE OFF VELOCITY is only available within the MOD MATRIX as a MODULATION SOURCE. It is not used elsewhere in the synthesizer. Please refer to the MOD MATRIX section later in this document for more details.

**VEL CURVE** - You can adjust the response curve for the VELOCITY here. The Hard setting will reduce the dynamic range of played notes. The Soft setting will increase the dynamic range of played notes.

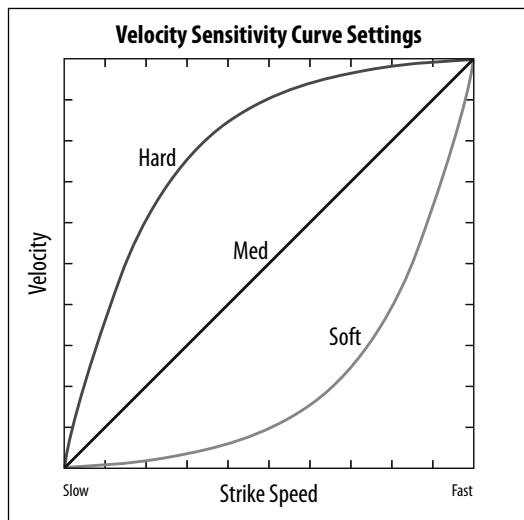

The default setting is Soft.

**AFT-CURVE** - You can adjust the response curve for the AFTERTOUCH here. The Hard setting will reduce the dynamic range of key pressure. The Soft setting will reduce the dynamic range of key pressure.

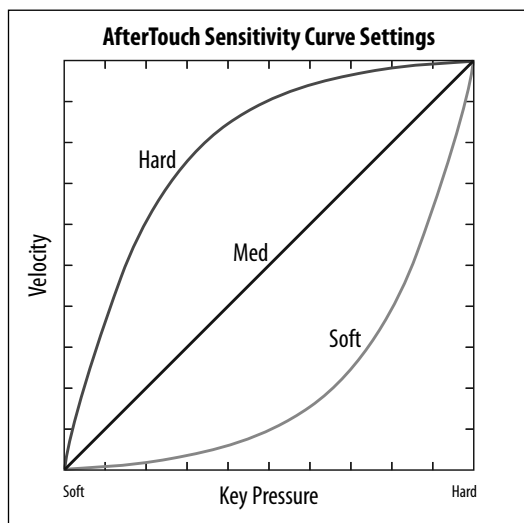

The default setting is Soft.

**Note:** The DeepMind 12 keyboard sends "Channel Aftertouch", meaning the MIDI message created is common to all keys.

**WHEEL-LEDS** - Both the PITCH WHEEL and the MODULATION WHEEL have the possibility to be illuminated, depending on your requirements. You can control the illumination mode here by selecting one of the following options:

**Auto** - In this mode, the illumination will get brighter as the respective wheel is moved, reaching its brightest point at the end of its travel.

**On** - In this mode the illumination is fixed on.

**Off** - In this mode the illumination is turned off.

The default setting is Auto.

To exit this menu press the PROG switch to return to the main programming screen, or press GLOBAL to cycle to the PEDAL SETTINGS menu.

**7.2.13 PEDAL SETTINGS**

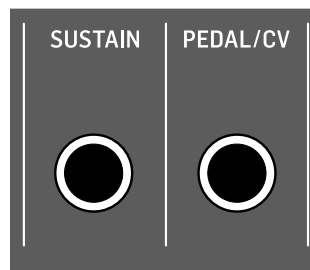

In this menu there are all the settings relating to PEDAL/CV and SUSTAIN inputs on the rear of the DeepMind 12.

To navigate the options in the PEDAL SETTINGS menu, use the UP and DOWN switches.

In order to change any of the parameters make sure that the '<' symbol on the respective line is highlighted.

Selected parameters are adjusted using the -NO/+YES switches, the rotary knob or the fader. The rotary knob has a click which allows very accurate control. The fader allows rapid adjustment across the full range.

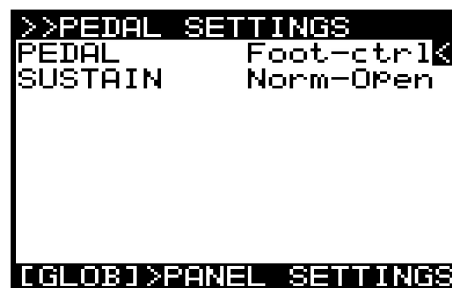

**PEDAL/CV** - This option allows you to choose the PEDAL/CV MODE from the following options:

The PEDAL/CV input can work with a typical foot pedal, where the voltage is supplied by the DeepMind 12 and fed back at a level which is dependant on the position of the pedal. The further the pedal is pressed, the higher the voltage.

The PEDAL/CV input can also work with a CV (Control Voltage) input from any source with a 0 to +5V output e.g. the Control Voltage from a modular synthesizer.

**Note:** For wiring diagrams and pin connections information please consult the guide later in this document.

The PEDAL input takes the voltage from the connector and turns it into a control signal. The control signal can be mapped to any of the following:

- **Foot-ctrl** - The Foot-Ctrl (Foot Controller) is available as a modulation source in the MOD MATRIX.
- **Mod-Wheel** - Here the PEDAL input is mapped to the MODULATION WHEEL which is available as a modulation source in the MOD MATRIX.
- **Breath** - Here the PEDAL input is mapped to the BREATH controller which is available as a modulation source in the MOD MATRIX.
- **Volume** - Here the PEDAL input is mapped to the VOLUME controller.
- **Expression** - Here the PEDAL input is mapped to the EXPRESSION controller.

The default setting is **Foot-ctrl**.

**SUSTAIN** - This option allows you to choose the SUSTAIN MODE from the following options:

The SUSTAIN input can work with a switched input which is either open when pressed, or closed when pressed.

**Gate Functionality** - The SUSTAIN input can also be used with a GATE signal from a CV and GATE interface or a modular synthesizer. This functionality requires the GATE signal to operate between +5V and 0V.

**Note:** For wiring diagrams and pin connections information please consult the guide later in this document.

- **Norm-Open** Here when the connected switch is pressed the notes are held in the SUSTAIN stage of all ENVELOPES. In this mode the correct operation is designed for a switch whose contacts close when pressed.
- **Norm-Closed** Here when the connected switch is pressed the notes are held in the SUSTAIN stage of all ENVELOPES. In this mode the correct operation is designed for a switch whose contacts open when pressed.
- **Tap-N.0** Here the SUSTAIN input is mapped to the TAP function so when the switch is pressed a signal is sent to the Master BPM Generator. In this mode the correct operation is designed for a switch whose contacts close when pressed.
- **Tap-N.C** Here the SUSTAIN input is mapped to the TAP function so when the switch is pressed a signal is sent to the Master BPM Generator. In this mode the correct operation is designed for a switch whose contacts open when pressed.
- **Arp+Gate** Here the SUSTAIN input is mapped to the ARPEGGIATOR notes, so when a GATE input from a CV & GATE interface, or a modular synthesizer is connected, the gate signal will step through the notes of the ARPEGGIATOR. In this mode the ARPEGGIATOR note duration is set by length of time that the gate signal is high (+5V).
- **Arp-Gate** Here the SUSTAIN input is mapped to the ARPEGGIATOR notes, so when a GATE input from a CV & GATE interface, or a modular synthesizer is connected, the gate signal will step through the notes of the ARPEGGIATOR. In this mode the ARPEGGIATOR note duration is set by length of time that the gate signal is low (0V).
- **Seq+Gate** Here the SUSTAIN input is mapped to the CONTROL SEQUENCER steps, so when a GATE input from a CV & GATE interface, or a modular synthesizer is connected, the gate signal will move through the steps of the CONTROL SEQUENCER. In this mode the CONTROL SEQUENCER will transition to the next step each time a positive edge (a transition from 0V to 5V) is received.
- **Seq-Gate** Here the SUSTAIN input is mapped to the CONTROL SEQUENCER steps, so when a GATE input from a CV & GATE interface, or a modular synthesizer is connected, the gate signal will move through the steps of the CONTROL SEQUENCER. In this mode the CONTROL SEQUENCER will transition to the next step each time a negative edge (a transition from 5V to 0V) is received.
- **Arp&Seq+Gate** Here the SUSTAIN input is mapped to the ARPEGGIATOR notes, and to the CONTROL SEQUENCER steps. When a GATE input from a CV & GATE interface, or a modular synthesizer is connected, the gate signal will step through the notes of the ARPEGGIATOR, and also move through the steps of the CONTROL SEQUENCER. In this mode the ARPEGGIATOR note duration is set by length of time that the gate signal is high (+5V). Also in this mode the CONTROL SEQUENCER will transition to the next step each time a positive edge (a transition from 0V to 5V) is received.
- **Arp&Seq-Gate** Here the SUSTAIN input is mapped to the ARPEGGIATOR notes, and to the CONTROL SEQUENCER steps. When GATE input from a CV & GATE interface, or a modular synthesizer is connected, the gate signal will step through the notes of the ARPEGGIATOR, and also move through the steps of the CONTROL SEQUENCER. In this mode the ARPEGGIATOR note duration is set by length of time that the gate signal is low (0V). Also in this mode the CONTROL SEQUENCER will transition to the next step each time a negative edge (a transition from 5V to 0V) is received.

The default setting is Norm-Open.

To exit this menu press the PROG switch to return to the main programming screen, or press GLOBAL to cycle to the PANEL SETTINGS menu.

#### 7.2.14 PANEL SETTINGS

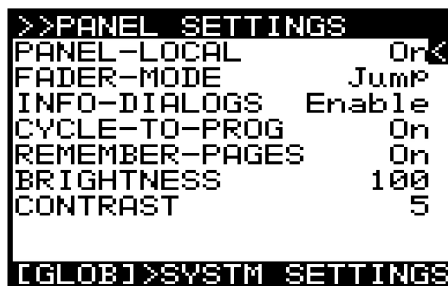

**PANEL-LOCAL** - This option turns LOCAL CONTROL for the DeepMind 12 panel controls (including all faders, non menu edit switches and portamento knobs) On and Off. It is sometimes useful to turn LOCAL CONTROL off when using the DeepMind 12 to control other hardware/software synthesizers, effects and/or applications.

The default setting is On.

**FADER MODE** - This option allows you to choose the mode in which the faders respond when you initially move a fader which has a different physical position to the stored value. You can choose one of the following options:

- **Pass-thru** - In this mode, when the fader is moved, it will need to "Pass-thru" the stored value before it will start to change.
- **Jump** - In this mode, when the fader is moved the value of the parameter will "Jump" to the physical position of the fader.

The default setting is Jump.

**INFO DIALOGS** - This option allows you to disable the pop-up dialogs and messages which are designed to aid you while learning how the DeepMind 12 operates. The default setting is Enable.

**CYCLE TO PROG** - When this option is turned On, the menu cycle function will return you to the programming screen. When this option is Off, the menu cycle function will return you to the first menu page. The default setting is On.

**REMEMBER PAGES** - With this option turned on your position in any menu will be remembered so that you return to the same position you left. When this option is off, any access of a menu will always position you in the first menu page. The default setting is On.

**BRIGHTNESS** - This option allows you to control the brightness of the display. The range is 0-100, with 0 being dim and 100 being the brightest setting. This is useful if you are operating in low light conditions and want to protect your vision, or if you are working under strong lighting conditions and want to maximise visibility.

The default setting is 100.

**CONTRAST** - This option allows you to control the contrast of the display. The range is 0-14, with 0 being least contrast and 14 being the most contrast. This is useful to compensate for different viewing angles, and/or light conditions.

The default setting is 10.

To exit this menu press the PROG switch to return to the main programming screen.

## 7.2.15 SYSTEM SETTINGS

**Note:** To access successive GLOBAL pages just press the GLOBAL switch again to cycle through the pages.

In this menu are all the SYSTEM SETTINGS of the DeepMind 12. These include VERSION NUMBERS of the hardware/firmware, settings for the fan speed and access to the CALIBRATION routines.

To navigate the options in the SYSTEM SETTINGS menu, use the UP and DOWN switches.

In order to change any of the parameters make sure that the '<' symbol on the respective line is highlighted.

Selected parameters are adjusted using the -NO/+YES switches, the rotary knob or the fader. The rotary knob has a click which allows very accurate control. The fader allows rapid adjustment across the full range.

```
>>SYSTEM SETTINGS
HOST-VER    1.0-63016
VOICE-VER   1.0-63016
DSP-VER     1.0-63016
BOOT-VER    22
WIFI-VER    2.7.0.0
FAN-SPEED   176<
CALIBRATE   -->
BACKUP      -->
[GLOBAL]>EXIT
```

**HOST-VER** - This is the version number of the host firmware.

**VOICE-VER** - This is the version number of the voice circuit board.

**DSP-VER** - This is the version of the DSP firmware.

**BOOT-VER** - This is the version of the bootloader used to initialize the synthesizer.

**WIFI-VER** - This is the version of the WiFi.

**FAN-SPEED** - This allows you to adjust the fan speed. The fan speed is adjustable from 0 (off) to 255 (maximum). Adjust the fan speed to suit your listening conditions and preference. If the local temperature is high, please make sure that the fans are not turned off. The DeepMind 12 is equipped with 2 fans, one internal and one at the rear. At an approximate setting of 40 the internal fan is running and the rear fan is off.

## 7.2.16 CALIBRATE

This menu allows you to perform CALIBRATION of the VOICES, MOD WHEEL, PITCH WHEEL, AFTERTOUCH and PEDAL INPUT.

To navigate the options in the CALIBRATION menu, use the UP, DOWN, switches.

Selected parameters are adjusted using the -NO/+YES switches, the rotary knob or the fader. The rotary knob has a click which allows very accurate control. The fader allows rapid adjustment across the full range.

In order to start a calibration routine make sure that the '<' symbol on the appropriate CALIBRATE line is highlighted and press the +/YES switch.

```
>>CALIBRATION MENU
CALIBRATE VOICES --><
CAL MOD WHEEL    -->
CAL PITCH WHEEL  -->
CAL AFTERTOUCH  -->
CALIBRATE PEDAL  -->
[GLOBAL]>BACK [YES]>GO
```

The DeepMind 12 has 12 voices. Each voice has its own LFO, OSC, VCF, ENV and VCA stages.

The CALIBRATION routine is used for the Voice checking, OSC wave shapes, VCF self-oscillation, Pulse Width modulation and the VCA bias.

**VCF** - Unlike many other synthesizers, the DeepMind 12 is capable of accurate pitch tracking even when the filter resonance is pushed to (and past) the point where the filter starts to self-oscillate. When using this self-oscillating feature of the VCF as a sound source, the VCF calibration ensures the correct response when playing the entire scale of the keyboard.

The DeepMind 12 VCFs are calibrated at the factory during production. However, because its filters are voltage controlled and can be affected by extremes of temperature, you may need to use the built-in calibration function to fine tune them occasionally. Calibration may also be required after a firmware upgrade or when being requested to do so by an authorised Behringer support technician.

**OSC** - The DeepMind 12 OSCs are calibrated at the factory during production. The oscillators are discrete analog circuits but they are digitally controlled. Compared to a Voltage Controlled oscillator (VCO), the OSC has far superior stability, especially when they have a very high frequency, low-jitter master clock sources, as used in the DeepMind 12. This stage calibrates the slope of the sawtooth waveform to ensure even volume and pulse-width across the full range of the synthesizer.

This means that the OSCs should never need re-calibrating except for after a firmware upgrade or being requested to do so by an authorised Behringer support technician.

**CALIBRATE VOICES**

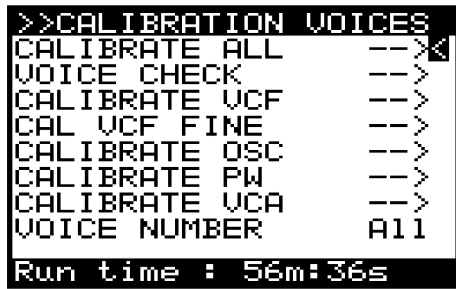

Overview of the calibration routines:

**ALL** - This will initiate all of the routine.

**VOICE CHECK** - This performs a series of functionality tests on each voice.

**VCF** - This routine puts the voice into self oscillation and tunes to 1 kHz in order to calibrate the resonance of the VCF for that voice. The routine then puts the voice into self oscillation and checks the tuning at 50 Hz, 220 Hz, 880 Hz and 10 kHz to ensure the VCF is performing as expected. The test is repeated for all voices.

**OSC** - This routine adjusts the slope of the sawtooth at octave intervals. This ensures the precision of the slope so that it performs as designed. The test is repeated for all voices.

**PW** - This routine adjusts the pulse width (mark to space ratio) of the pulsewave. This ensures the precision of the ratio so that it performs as designed. The test is repeated for all voices.

**VCA** - The Voltage Controlled Amplifier (VCA) uses a bias voltage to set its operating level. This bias voltage is balanced so that the VCA responds as designed. The test is repeated for all voices.

In order to start the calibration routine make sure that the '<' symbol on the appropriate CALIBRATE line is highlighted and press the +/YES switch.

**Note:** The calibration run time is shown on the bottom of the screen so that you can plan your work around any of the calibration phases.

The calibration routine will then start. Throughout the tests you will see various waveforms being played. It is safe to turn down the volume while the calibration routine is running.

**Note:** There is the option while the calibration is running to mute the signal using the BANK/DOWN switch and un-mute using the BANK/UP switch.

Once the calibration routine is complete you will see a summary of the test results as shown below:

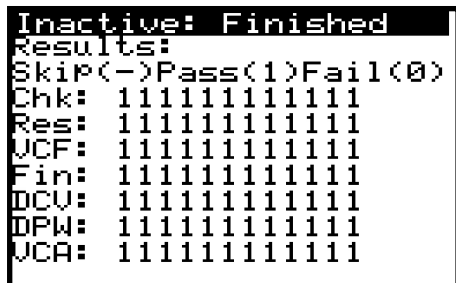

Note: During the calibration the GLOBAL and -/NO switches will be flashing. If at any time you want to cancel the calibration routine, you can press the -/NO switch. No previous calibration data will be changed if you do cancel the routine.

**CAL MOD WHEEL**

To calibrate the MOD WHEEL, please use the following process:

**Note:** During the calibration the GLOBAL, -/NO and +/YES switches will be flashing. If at any time you want to cancel the calibration routine, you can press the -/NO switch. No previous calibration data will be changed if you do cancel the routine. To confirm the calibration at each stage press +/YES as described below.

First move the MOD WHEEL to its minimum position (shown on the panel)

In order to start the calibration routine make sure that the '<' symbol on the CAL MOD WHEEL line is highlighted and press +/YES.

You will see the following display showing a bar representing the MOD WHEEL value. Also on this screen you can see the stored calibration data above the bar and the current value below the bar.

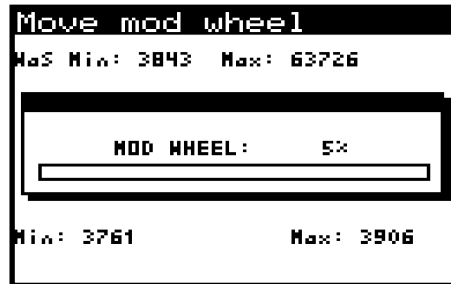

Then move the MOD WHEEL to its maximum position (shown on the panel).

You will see the following display showing the new position of the MOD WHEEL and the associated values:

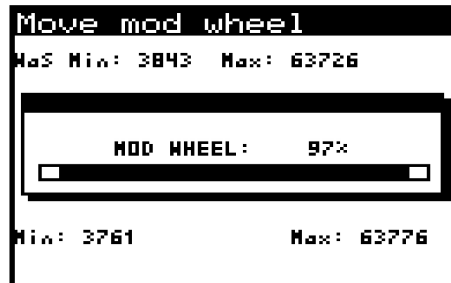

**Note:** To cancel the routine you can press the -/NO switch.

To confirm the CALIBRATION of the MOD WHEEL, press the +/YES switch: The calibration data will then be stored for the MOD-WHEEL and you will be returned to the CALIBRATE menu. From here you can perform another calibration from the menu, or press the GLOBAL switch again to return to the SYSTEM SETTINGS menu.

**CAL PITCH WHEEL**

To calibrate the PITCH WHEEL, please use the following process:

In order to start the calibration routine make sure that the '<' symbol on the CAL PITCH WHEEL line is highlighted and press +/YES.

You will see the following display showing a bar representing the PITCH WHEEL value. Also on this screen you can see the stored calibration data above the bar and the current value below the bar:

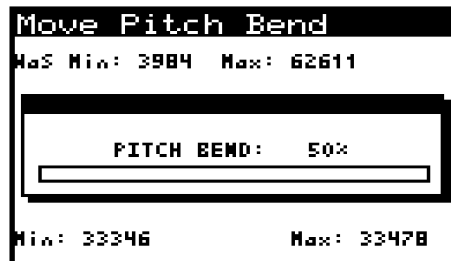

Then move the PITCH WHEEL to its maximum position (shown on the panel).

You will see the following display showing the maximum position of the PITCH WHEEL and the associated values:

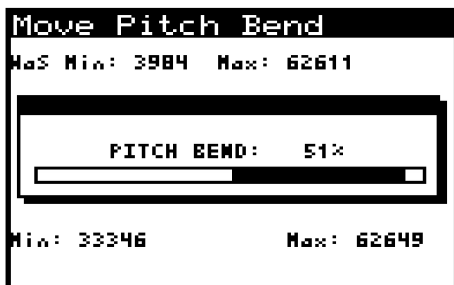

Then move the PITCH WHEEL to its minimum position (shown on the panel).

You will see the following display showing the minimum position of the PITCH WHEEL and the associated values:

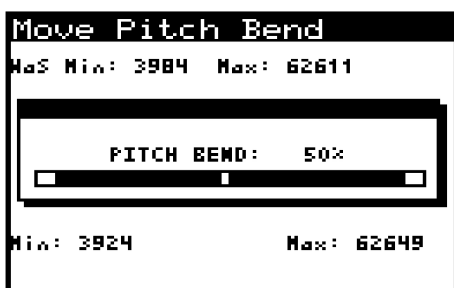

To confirm the CALIBRATION of the PITCH WHEEL press the +/YES switch and you will be moved on to the PITCH CENTRE page:



At this point move the PITCH WHEEL within the dead zone where you don't feel the tension of the spring. This is ensure that no pitch information is sent while the pitch wheel is not being touched. You will see the following display showing a guide to assist you:

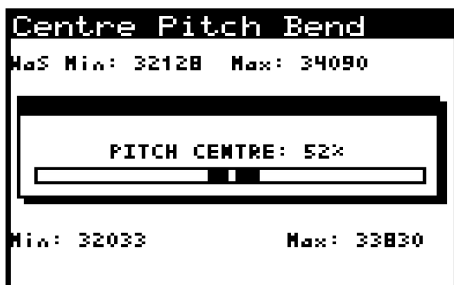

**Note:** To cancel the routine you can press the -/NO switch.

To confirm the CALIBRATION of the PITCH CENTRE press the +/YES switch: The calibration data will then be stored for the PITCH CENTRE and you will be returned to the CALIBRATE menu. From here you can perform another calibration from the menu, or press the GLOBAL switch again to return to the SYSTEM SETTINGS menu.

## CAL AFTERTOUCH

To calibrate the KEYBOARD AFTERTOUCH please use the following process:

**Note:** During the calibration the GLOBAL, -/NO and +/YES switches will be flashing. If at any time you want to cancel the calibration routine, you can press the -/NO switch. No previous calibration data will be changed if you do cancel the routine. To confirm the calibration at each stage press +/YES as described below.

In order to start the calibration routine make sure that the '<' symbol on the CAL AFTERTOUCH line is highlighted and press +/YES.

You will see the following display showing a bar representing the current AFTERTOUCH value (0% for no pressure). Also on this screen you can see the stored calibration data above the bar and the current value below the bar:

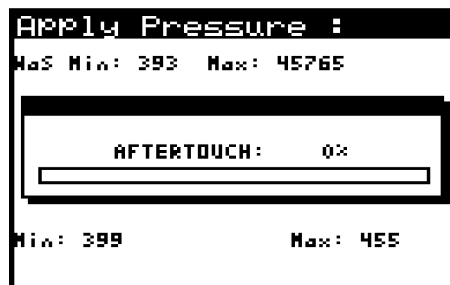

Then apply pressure to any one of the keys (or multiple keys) until the value stops increasing.

You will see the following display showing the maximum position of the AFTERTOUCH and the associated value:

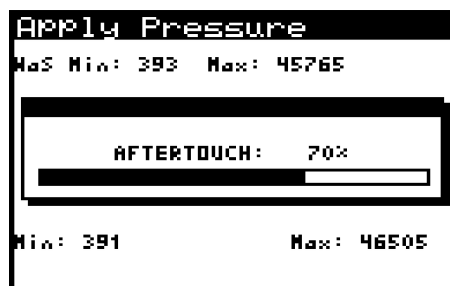

**Note:** To cancel the routine you can press the -/NO switch.

To confirm the CALIBRATION of the AFTERTOUCH press the +/YES switch: The calibration data will then be stored for the AFTERTOUCH and you will be returned to the CALIBRATE menu. From here you can perform another calibration from the menu, or press the GLOBAL switch again to return to the SYSTEM SETTINGS menu.



**CALIBRATE PEDAL**

To calibrate the PEDAL please use the following process:

**Note:** During the calibration the GLOBAL, -NO and +/YES switches will be flashing. If at any time you want to cancel the calibration routine, you can press the -/NO switch. No previous calibration data will be changed if you do cancel the routine. To confirm the calibration at each stage press +/YES as described below.

In order to start the calibration routine make sure that the '<' symbol on the CAL CALIBRATE PEDAL line is highlighted and press +/YES.

You will see the following display showing a bar representing the current PEDAL value (0% for no pressure). Also on this screen you can see the stored calibration data above the bar and the current value below the bar:

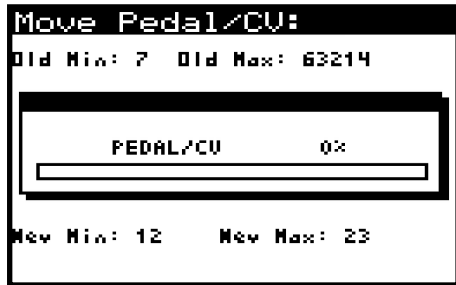

Then press the pedal until the value stops increasing.

You will see the following display showing the maximum position of the PEDAL input and the associated value:

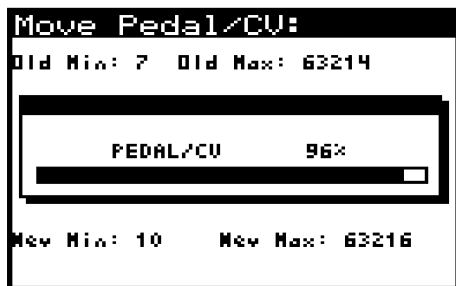

**Note:** To cancel the any routine you can press the -/NO switch, you will see the following message:

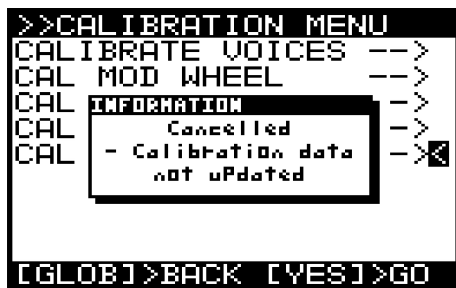

To confirm the CALIBRATION of the PEDAL input press the +/YES switch: The calibration data will then be stored for the PEDAL and you will be returned to the CALIBRATE menu. From here you can perform another calibration from the menu, or press the GLOBAL switch again to return to the SYSTEM SETTINGS menu.

**7.2.17 BACKUP (backup Menu)**

The last item in the SYSTEM SETTINGS menu is BACKUP.

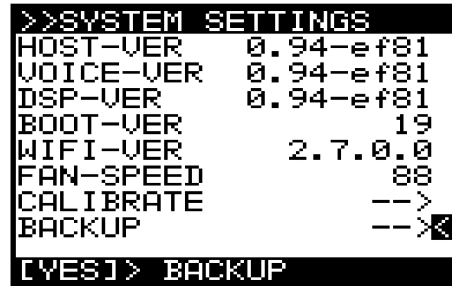

Pressing +/YES when "BACKUP -->" is selected, will bring up the BACKUP MENU. (The "RESTORE BANK" lines only appear after the first backup is done).



Pressing /YES when "BACKUP PROGRAMS" is selected, will bring up a confirmation dialog:



Pressing YES again, copies all Banks of programs from EEPROM to flash, and overwrites the "factory default" data.

Pressing +/YES when any of the RESTORE-BANK-A to RESTORE-BANK-H lines is selected, will bring up a confirmation dialog:



Pressing YES again will restore the selected bank from flash.

### 7.3 COMPARE (Compare Menu)

The COMPARE feature has two main functions:

Firstly you can use it to COMPARE the current (edited) program with the original program.

Secondly you can use it to COMPARE and/or match the current position of the physical faders on the surface with the original program. This is necessary when you wish to maintain the sound/character of the program.

To perform both functions simply press the COMPARE switch.



**Note:** If you have not edited the program (i.e. changed some parameters) when you press the COMPARE switch you will restore the backup as described in a previous chapter.

Firstly the sound/character will return to its original state so that you can compare your edits. Note: If you do not want to match the fader positions you can simply press COMPARE again to return to programming.

Secondly, you now have the option to match the position of the physical faders to the positions stored in the original program.

You will then see a page of the COMPARE menu (page 1 is displayed below). The page shown will be the last page you used. If you have never used the COMPARE function since turning the DeepMind 12 on, it will default to page 1.

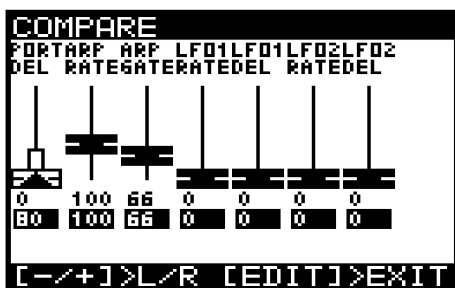

Each page of the COMPARE menu shows a section of the faders .

If the position of the fader matches the position of the stored value the fader will be black.

If the fader does not match the position it will be white with a superimposed arrow pointing in the direction it needs to move in order to approach the stored value.

There is also a white bar to show how far the fader needs to move in order to match the stored value.

Once the fader reaches the stored position it will turn black to indicate it is now matched.

**Note:** The pages will switch automatically when you begin to adjust any of the faders.

There are four pages of faders in the COMPARE menu, to access the other pages use the +/- switches to select the previous/next pages.

Page 1 Shows the PORTAMENTO rotary and the ARP/SEQ/LFO faders:



Page 2 shows the OSC faders:



Page 3 shows the UNISON, VCF, HPF and VCA faders:



Page 4 shows the ENVELOPE faders:

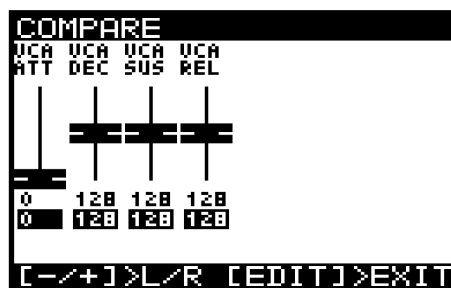

**Note:** You can still select specific envelopes to match the faders depending on your requirements.

## 7.4 WRITE (Write Menu)

To write a program to memory press the WRITE switch to open the WRITE PROGRAM menu.



The WRITE PROGRAM menu will then appear:

```
WRITE PROGRAM
E-1 Default Program
category:NONE
TO BE REPLACED BY
E-1 Default Program
Press..
WRITE: Confirm
COMPARE: Listen
PROG: Cancel
```

In this menu you can use the -NO/+YES switches to navigate through the sections. The selected section will be highlighted by an inverted character (white on black).

The first section is the program location the current program will be saved. You can use the UP/DOWN switches, the rotary knob, or the fader to select the required BANK (A-H) and PROGRAM NUMBER (1-128).

The second section is the CATEGORY to select any of the available categories. Again you can use the UP/DOWN switches, the rotary knob, or the fader to select the required CATEGORY.

The third section is REPLACED BY which allows you to name the program to be written. You can use the -NO/+YES switches to step through each character of the name and use the UP/DOWN switches, the rotary knob, or the faders to change the character.

There are also two short-cuts for selecting characters indicated by text above the FX and GLOBAL switches:

```
WRITE PROGRAM
E-1 Default Program
category:NONE
TO BE REPLACED BY
E-1 Default Program
Press..
WRITE: Confirm
COMPARE: Listen
PROG: Cancel
a-A-0- DEL
```



**a-A-0** - Pressing the FX switch will cycle between lower-case, upper-case and numbers.

**DEL** - Pressing the GLOBAL switch will delete the currently selected character.

**Note:** These short-cuts only appear when you are editing the name of the REPLACED BY program.

To compare the current program with the intended program location you can press the COMPARE switch to listen to the difference. To return to the current program, press the compare switch again.



Once you have selected the new location and named the program simply press the WRITE switch again to write the program.

At anytime you decide you do not want to write the program, you can press the PROG switch to return to the main programming display. Note: If there is a program in the backup memory then you will see the message "COMPARE to clear backup".

```
WRITE PROGRAM
E-1 Default Program
category:NONE
TO BE REPLACED BY
E-1 Default Program
Press..
WRITE: Confirm
COMPARE: Clear Backup
PROG: Cancel
```

If you wish to listen to the intended program location as described earlier you will need to press the COMPARE switch to clear the backup memory. Once the backup has been cleared then the message will revert to "COMPARE to listen" and you can listen to the intended program location as normal.

## 7.5 Re-naming Programs

To rename a program simply follow the procedure for writing a program and keep the BANK and PROGRAM NUMBER the same.

## 8. Programming

### 8.1 CHORDS/ARP/SEQ/SYNC SETTINGS

The ARP/SEQ section controls all parameters relating to the internal ARPEGGIATOR, CONTROL SEQUENCER and PATTERN editing. This section also contains the controls for CHORD and POLY CHORD programming.

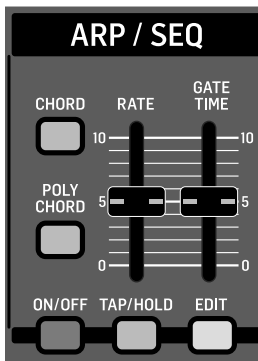

**CHORD / POLY CHORDS** - You can program a single chord to be mapped across the entire keyboard, or multiple chords to individual keys/notes.

**ARPEGGIATOR** - The DeepMind 12 ARPEGGIATOR allows you to play a pattern based on the individual keys being held. The patterns note order can be selected from a number of modes. The tempo of the ARPEGGIATOR can be sourced from either an internal or external clock. The clock can be divided from the Master BPM allowing you to select different timing structures.

The ARPEGGIATOR also has a looping pattern editor which allows you to adjust velocity and gate values for each step. The pattern editor has 32 "Fixed Presets" allowing you to start using the patterns quickly and 32 "User Presets" so that you can store your own unique patterns. The patterns can be up to 32 steps long allowing a large range of creative possibilities.

There is also a clock swing feature which allows you to fine tune the swing (or "groove") to your specific requirements.

The ARPEGGIATOR can be set to synchronize with the first key you strike, or synchronised with the Master BPM clock (internal or external).

**CONTROL SEQUENCER** - The DeepMind 12 CONTROL SEQUENCER is not part of the ARPEGGIATOR. The CONTROL SEQUENCER is a modulation source in the same way an LFO or ENVELOPE is. The CONTROL SEQUENCER allows you to create a pattern which can be used to modulate other parameters. The tempo of the CONTROL SEQUENCER can be sourced from either an internal or external clock. The clock can be divided from the Master BPM allowing you to select different timing structures.

The CONTROL SEQUENCER has a looping editor which allows you to adjust the values for each step. The modulation waveform that is produced can have negative or positive values. The CONTROL SEQUENCER can be up to 32 steps long allowing a large range of creative possibilities.

There is also a clock swing feature which allows you to fine tune the swing (or "groove") to your specific requirements.

The CONTROL SEQUENCER can be set to synchronize with the first note you strike, or synchronised with the Master BPM clock (internal or external).

For more information on using the CONTROL SEQUENCER as a modulation source please consult the MOD MATRIX section later in this document.

**CLOCK NOTES** - One the great advantages of having a Master BPM is that the LFOs, ENVELOPES, and many EFFECTS parameters of the DeepMind 12 can be synchronised to the BPM.

#### 8.1.1 CHORD SWITCH

The DeepMind 12 CHORD switch allows you to program a chord to memory. That chord is then transposed across the full range of the keyboard.

##### CHORD SCREEN UPPER SECTION

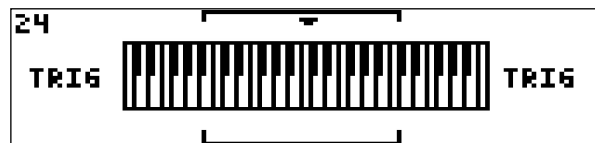

On the upper section of the CHORD screen there is a visual representation of the four physical octaves of the keyboard. The words next to the keyboard describe what is shown (NOTE or TRIG). The bracket shows the zoom position for the lower section. The number in the top left hand corner shows the MIDI note number.

##### CHORD SCREEN LOWER SECTION

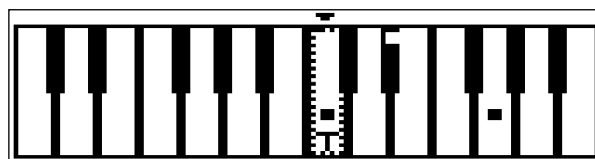

On the lower section of the CHORD screen there is a visual representation of the keyboard which is zoomed to the two octaves represented by the vertical brackets on the top section. The letter T shows the last played trigger key. The small indicator dots on the keys show the currently played notes during recording.

##### CHORD SCREEN SOFT KEYS

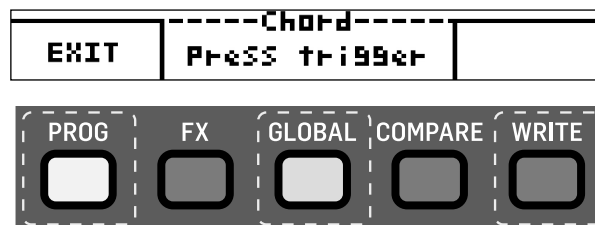

At the bottom of the CHORD page you will see three areas which indicate the software function of the PROG, GLOBAL and WRITE switches.

**PROG switch** - Always perform the EXIT function and return you to the PROG screen.

**GLOBAL switch** - Only used to RECORD a new CHORD. Otherwise the area above the switch is used to show the status of the CHORD programming function i.e. Armed, Learning, or Press Trigger.

**WRITE switch** - Used to DELETE the chord, but only once a chord is programmed (otherwise this area will be blank and the switch will not be illuminated)

**Note:** The CHORD is stored in persistent memory and will be retained through a power cycle.

**Note:** The CHORD memory can also be cleared using the bootloader menu described later in this document.

**CHORD PROGRAMMING** - To program a chord, press the CHORD switch (or the RECORD soft switch if replacing an existing chord). The CHORD switch will begin double flashing and you will then see the screen with the message "Armed" as shown below:

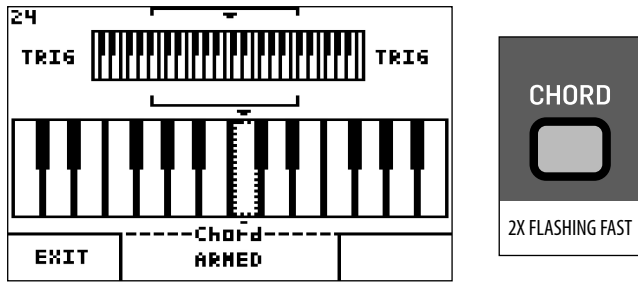

While the message "Armed" is shown, hold the keys of the chord down and you will then see the screen with the message "Learning" below:

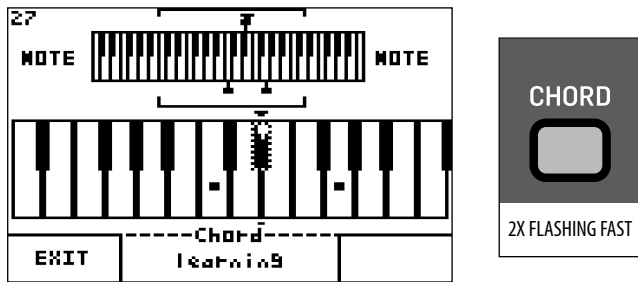

At this point you can add additional notes to the chord. Once you have all the keys required held down simultaneously you can release them all. The chord will then be ready to be assigned and the CHORD switch will flash slowly.

**Note:** The CHORD size is limited to 12 notes.

You will see a message to "Press Trigger" as shown below:

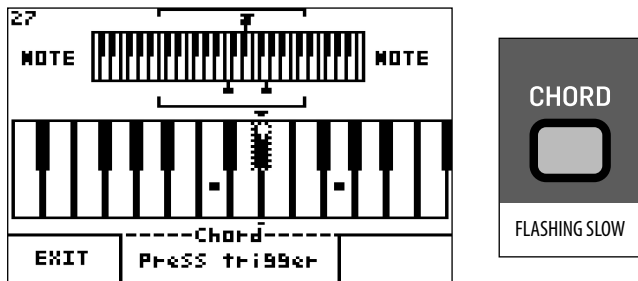

Now press the root note key for the chord to be transposed up or down from. Once you press a key, the chord you played will have its root note assigned to that key. The CHORD switch will then stay illuminated (no flashing) and the CHORD mode will be active for the entire keyboard (including any OCTAVE shift applied).

**Note:** In CHORD mode you can only play one key/CHORD at a time. I.e. when you hold a key down then press another key, the CHORD will be played from the last pressed key only.

The screen will now show the following:

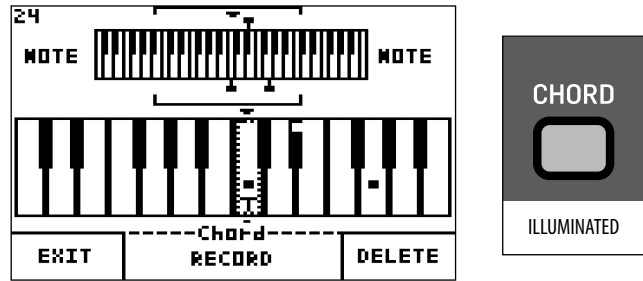

Now playing any key on the keyboard will play the CHORD you have programmed. The CHORD will be transposed from the root note to the key that you are playing.

**RECORDING A NEW CHORD** - To record a new chord (and overwrite the existing chord), press the RECORD soft switch. The existing chord will be deleted and you will see the message "Armed" indicating that the synthesizer is ready to program a new CHORD.

**DELETING THE CHORD** - To delete the chord press the DELETE soft switch. The chord will be deleted and you will see the message "Armed" indicating that the synthesizer is ready to program a new CHORD.

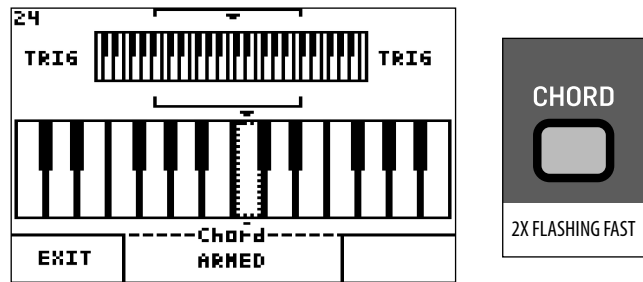

**EXITING THE CHORD SCREEN** - Press the EXIT soft switch to exit the CHORD page. This will return you to the PROG screen but CHORD mode will still be active and the CHORD switch will be illuminated.

**EXITING CHORD MODE** - Press the CHORD switch again to turn off CHORD MODE, the switch will no longer be illuminated.

**Note:** When the keyboard local control is on, all chords will be sent to any connected devices. When keyboard local control is off only the trigger note will be sent to any connected devices. When the trigger notes are received the DeepMind 12 will play respective chords based on incoming trigger notes.

### 8.1.2 POLY CHORD SWITCH

The DeepMind 12 POLY CHORD switch allows you to program multiple chords to memory. The chords can be assigned to any of the 49 physical keys.

#### POLY CHORD SCREEN UPPER SECTION

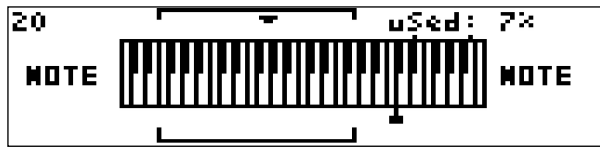

On the upper section of the POLY CHORD screen there is a visual representation of the four physical octaves of the keyboard. The words next to the keyboard describe what is shown (NOTE or TRIG). The bracket shows the zoom position for the lower section. The number in the top left hand corner shows the MIDI note number. The number in the top right hand corner indicates how much of the available memory has been used.

#### POLY CHORD SCREEN LOWER SECTION

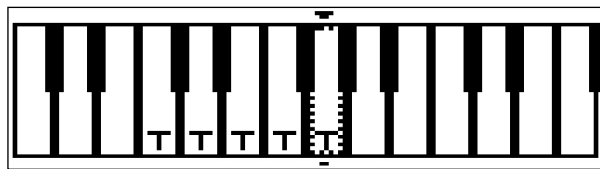

On the lower section of the POLY CHORD screen there is a visual representation of the keyboard which is zoomed to the two octaves represented by the vertical brackets on the top section. The letter T is shown on all trigger keys, i.e. the keys which are programmed to play a chord when pressed. The small indicator dots on the keys show the currently played notes in the selected chord or during recording.

#### POLY CHORD SCREEN SOFT KEYS



At the bottom of the POLY CHORD page you will see three areas which indicate the software function of the PROG, GLOBAL and WRITE switches.

**PROG switch** - Always performs the EXIT function and returns you to the PROG screen.

**GLOBAL switch** - Used to RECORD (add or overwrite) a new POLY CHORD. Otherwise the area above the switch is used to show the status of the POLY CHORD programming function i.e. Armed, Learning, or Press Trigger.

**WRITE switch** - Used to DELETE a chord, but only once a chord is programmed (otherwise this area will be blank and the switch will not be illuminated) Note: The CHORD is stored in persistent memory and will be retained through a power cycle.

**Note:** The CHORD memory can also be cleared using the bootloader menu described later in this document.

**POLY CHORD PROGRAMMING** - To program a chord, press the POLY CHORD switch (or the RECORD switch if replacing or adding an existing chord). The POLY CHORD switch will begin double flashing and you will then see the screen with the message "Armed" as shown below :

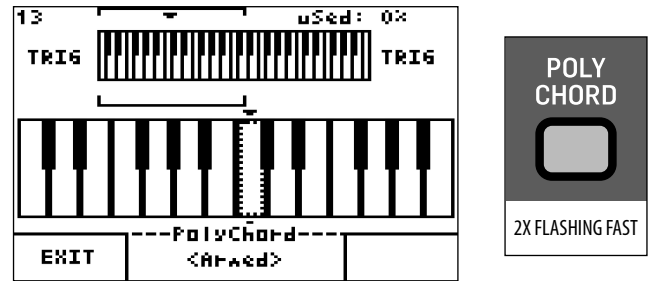

While the message "Armed" is shown, hold the keys of the chord down and you will then see the screen with the message "Learning" below:

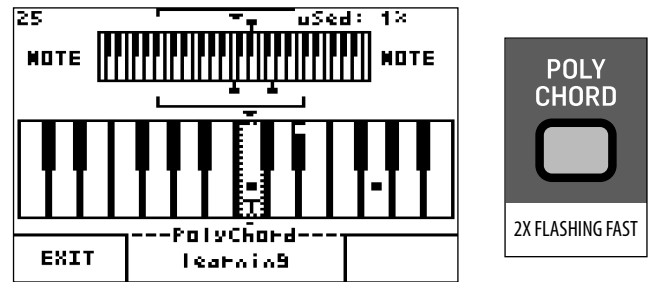

At this point you can add additional notes to the chord. Once you have all the keys required held down simultaneously you can release them all. The chord will then be ready to be assigned and the POLY CHORD switch will flash slowly.

**Note:** The POLY CHORD size is limited to 12 notes.

You will see a message to "Press Trigger" as shown below:

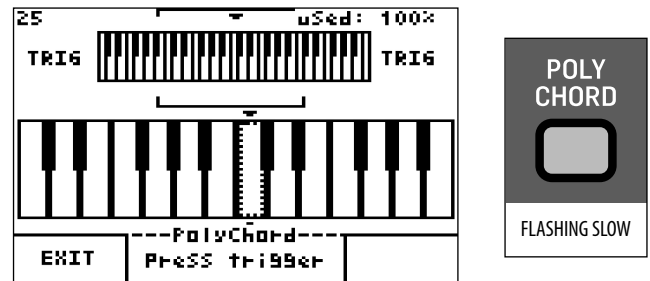

Now press the root note key for the chord to be assigned to. Once you press a key, the chord you played will be assigned to that key. The POLY CHORD switch will then stay illuminated (no flashing) and the POLY CHORD mode will be active for the entire keyboard (including any OCTAVE shift applied).

The screen will now show the following:

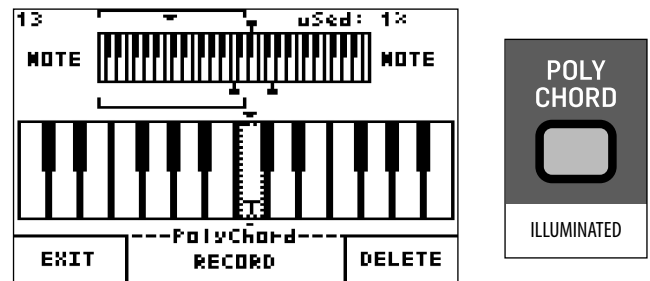

Now playing any of the trigger keys will play the chords assigned to the respective keys.

**RECORDING / ADDING A NEW POLY CHORD** - To record/add a new chord, press the RECORD soft switch. You will now see the message "Armed" indicating that the synthesizer is ready to program a new CHORD.

Each of the keys which have been assigned to trigger a chord, will be marked with the letter T as shown below:

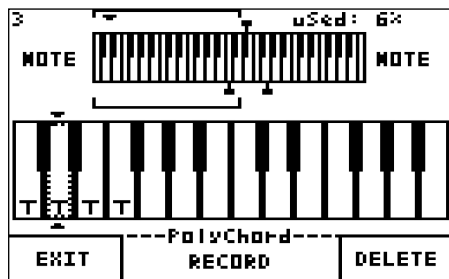

**DELETING A POLY CHORD** - To delete a chord you first need to select the trigger key. This can be done using the rotary knob, the -/NO and +/YES switches, or by pressing the trigger key for the chord you wish to delete.

The selected key will be highlighted by a dotted line as shown above. When the key is selected press the DELETE soft switch. The chord will be deleted and the letter T will no longer be shown. You will also see the message "Armed" indicating that the synthesizer is ready to record a new CHORD.

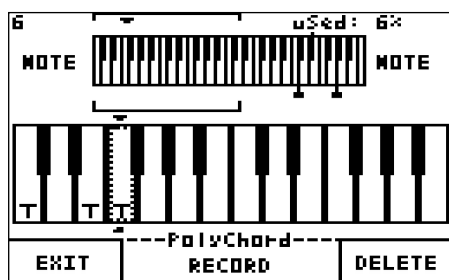

**EXITING THE POLY CHORD SCREEN** - Press the EXIT soft switch to exit the POLY CHORD page. This will return you to the PROG screen but POLY CHORD mode will still be active and the POLY CHORD switch will be illuminated.

**EXITING POLY CHORD MODE** - Press the POLY CHORD switch again to turn off POLY CHORD MODE, the switch will no longer be illuminated.

**Note:** In POLY CHORD mode you can play a sequence of chords using the trigger keys while playing individual notes using unassigned keys.

**Note:** You can use the rotary knob and/or the -/NO and +/YES switches to scroll the zoomed view up and down the keyboard. This is useful when you want to see any playing notes which are outside of the current zoom position.

**Note:** When the keyboard local control is on, all chords will be sent to any connected devices. When keyboard local control is off only the trigger note will be sent to any connected devices. When the trigger notes are received the DeepMind 12 will play respective chords based on incoming trigger notes.

**Note:** The number of POLY CHORDs you can program is limited, depending on the number of notes used in each POLY CHORD. There is enough space for 216 notes, e.g. 36 x 6 note POLY CHORDs.

### 8.1.3 ARP ON/OFF SWITCH

The ON/OFF switch in the ARP/SEQ section turns the ARPEGGIATOR function ON and OFF. When the ARPEGGIATOR is switched ON and you hold down one or more keys the ARPEGGIATOR will start playing. When you release all keys the ARPEGGIATOR will stop playing.



**Note:** The ON/OFF switch only affects the ARPEGGIATOR, it does not affect the CONTROL SEQUENCER.

The default ON/OFF setting is OFF.

### 8.1.4 TAP/HOLD SWITCH



The TAP/HOLD switch has two functions:

**TAP** - When you strike the TAP switch successively the DeepMind 12 will calculate the Master BPM value from the tempo of your tapping. After 5 taps the BPM will update to the tempo of your tapping.

The BPM is calculated on an average of the last 5 taps, so you can continue tapping until you feel the displayed tempo is correct.

**Note:** If you are using an external sync source the TAP/HOLD switch will flash at the rate of the external source.

The supported TAP TEMPO range for both internal and external sources is from 20.0-275.0 BPM

**HOLD** - When you press and hold the TAP/HOLD switch for more than 1 second, the switch is illuminated and HOLD mode is active. In this mode when you press any key it will be held on and the ARPEGGIATOR will continue playing.

If you press a key and hold it down, you can add other notes to the ARPEGGIATOR. Once you release all keys the ARPEGGIATOR will continue to play until you press another key.

**Note:** The HOLD switch can also be used without the ARPEGGIATOR function. When the ARPEGGIATOR is off and the HOLD switch is pressed it will hold and played notes in their SUSTAIN phase of all ENVELOPES. This can be useful during sound design when you want to work on the sustained content of a program and operate the surface controls with both hands.

To turn HOLD mode off press and hold the TAP/HOLD switch again for more than 1 second, the switch is no longer illuminated and HOLD mode is no longer active.

The default HOLD setting is OFF.

### 8.1.5 ARP RATE FADER

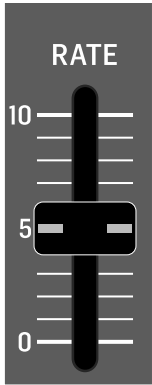

The RATE fader controls the Master BPM RATE of the ARPEGGIATOR. The Master BPM is used by the ARPEGGIATOR, CONTROL SEQUENCER and is also used in any parameters which can be linked to the Master BPM, such as the LFO, Envelopes and some Effect parameters.

Decreasing the value will make the Master BPM RATE slower, and increasing the value will make the Master BPM rate faster as shown below:

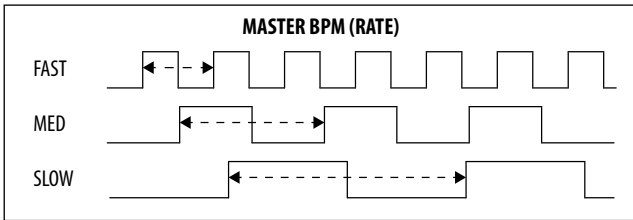

The Master BPM RATE range is from 20.0 to 275.0 BPM. The default Master BPM RATE value is 120.0 BPM.

The fader position, current value and stored value for the ARP RATE fader is shown on the PROG screen. There is also a visualization of the ARP RATE as shown below:

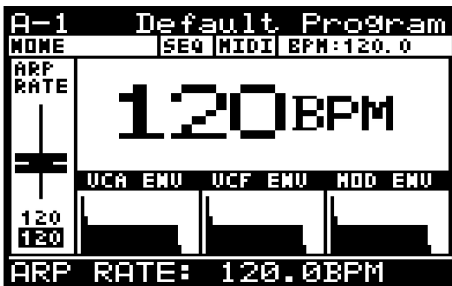

### 8.1.6 ARP GATE TIME FADER

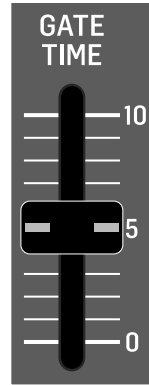

The GATE TIME fader controls the length of the note as shown below.

With the fader in the middle position, the GATE TIME is equally split so that the note length is exactly half of a step. Decreasing the value will make the GATE TIME shorter, and increasing the value will make the GATE TIME longer as shown below:

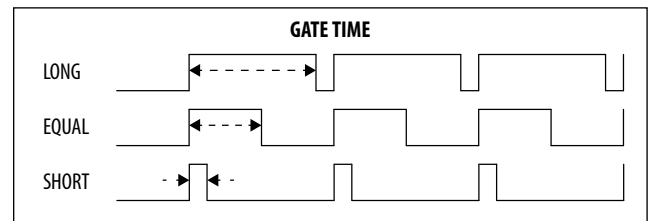

**Note:** The GATE TIME FADER on the front panel, and the GATE TIME PARAMETER in the PATTERN EDITOR both affect the length of the notes.

With the GATE TIME FADER at maximum the note length matches the full length of the PATTERN GATE TIME.

When the GATE TIME fader is in the middle then the note length is half of the PATTERN GATE TIME.

The GATE TIME range is from 0 to 255, with 0 being no note and 255 being a full note. The default GATE TIME value is 128, which represents half of a step.

The fader position, current value and stored value for the ARP GATE TIME fader is shown on the PROG screen. There is also a visualization of the ARP GATE TIME period, using the width of two consecutive notes as shown below:

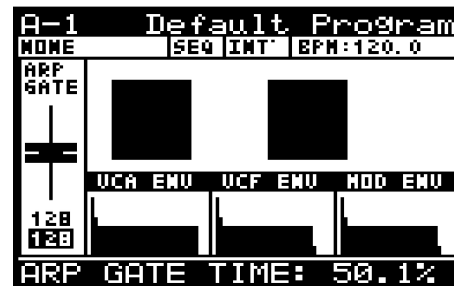



### 8.1.7 EDIT ARP/SEQ SWITCH

The DeepMind 12 ARPEGGIATOR allows you to play a pattern of notes based on the individual keys being held. This section covers in detail all the parameters related to the ARPEGGIATOR.

To enter the EDIT page for the ARPEGGIATOR & CONTROL SEQUENCER press the EDIT switch.

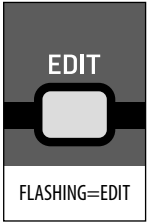

The EDIT switch will then start flashing and the ARPEGGIATOR menu will then appear:

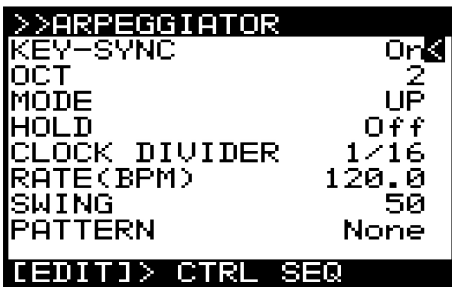

**Note:** In the ARP/SEQ EDIT menu there are three pages (ARPEGGIATOR, CONTROL SEQUENCER and SYNC SETTINGS). This section covers the ARPEGGIATOR menu. To cycle through the pages use consecutive presses of the EDIT switch. The bottom line of the screen will show guidance to the next page.

To navigate the options in the ARPEGGIATOR menu, use the UP, DOWN, switches.

Selected parameters are adjusted using the -NO/+YES switches, the rotary knob or the fader. The rotary knob has a click which allows very accurate control. The fader allows rapid adjustment across the full range.

**KEY SYNC** - This option allows you to turn KEY-SYNC (Key Synchronisation) On and Off. When KEY-SYNC is On, the arpeggiator will start playing at soon as you strike the first note (when no keys are pressed). When KEY-SYNC is Off, the arpeggiator will start playing using the Master BPM (internal or external) and ARP CLOCK (after division) as its timing source. The default value is Off.

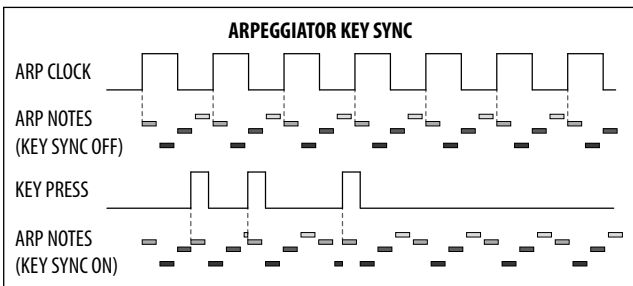

**OCT** - This option allows you to choose how many OCTAVES the ARPEGGIATOR will cycle through. The OCTAVE range is from 1 to 6. If you only choose one OCTAVE the ARPEGGIATOR will simply cycle the notes based on the root note and the MODE. If you choose more than one OCTAVE the ARPEGGIATOR will cycle through the notes/MODEs for each OCTAVE sequentially.

The default value is **2 OCTAVES**.

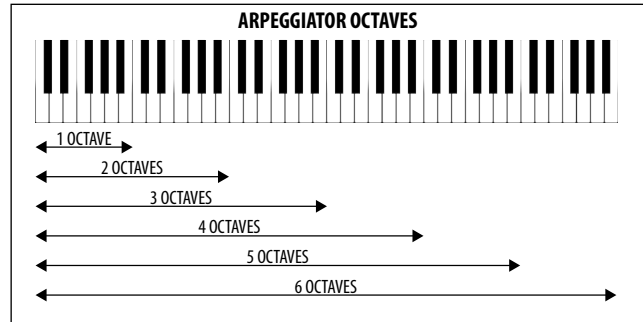

**MODE** - This option allows you to select the note order for the arpeggiator from one of the options below:

- **UP** - Notes are played from the lowest to the highest, then repeated.

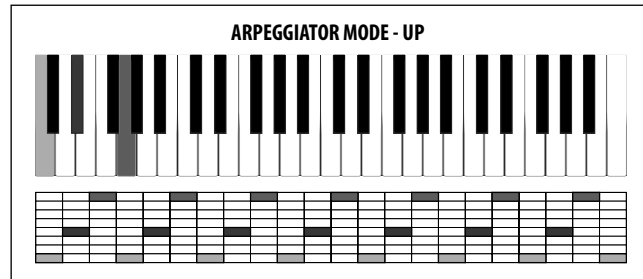

- **DOWN** - Notes are played from the highest to the lowest, then repeated.

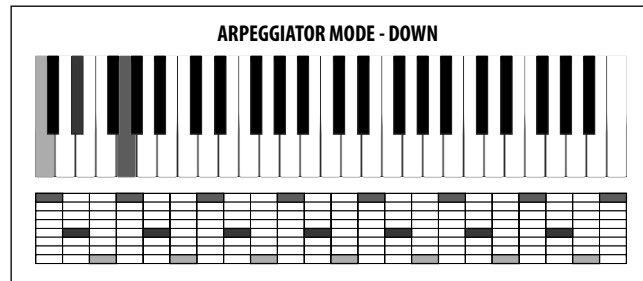

- **UP-DOWN** - Notes are played from the lowest to the highest, then from the highest to the lowest, then repeated. There is no repetition at the highest and lowest notes.

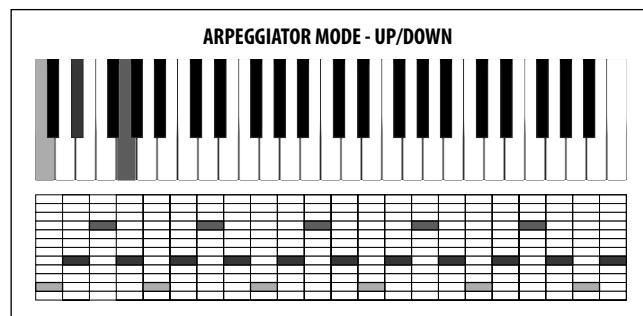

- **UP-INV** - Notes are played from the lowest to the highest, then the chord is inverted and the notes are played from the lowest to the highest. This is then repeated. There is no repetition at the highest and lowest notes.

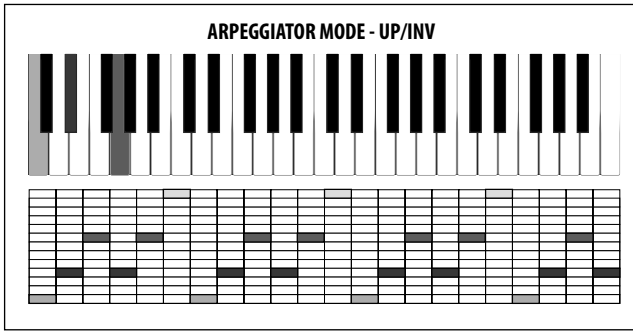

- **DOWN-INV** - Notes are played from the highest to the lowest, then the chord is moved to its 2nd inversion and lowered one octave then the notes are played from the highest to the lowest. This is then repeated. There is no repetition at the highest and lowest notes.

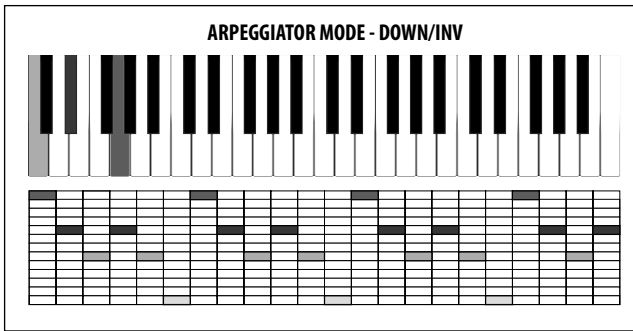

- **UP-DN-INV** - Notes are played from the lowest to the highest, then the chord is moved to its 1st inversion and the notes are played from the lowest to the highest. Next the chord is moved to its 2nd inversion and the notes are played from the highest to the lowest. Then the chord is moved back to the 1st inversion and the notes are played from the highest to the lowest. This is then repeated. There is no repetition at the highest and lowest notes.

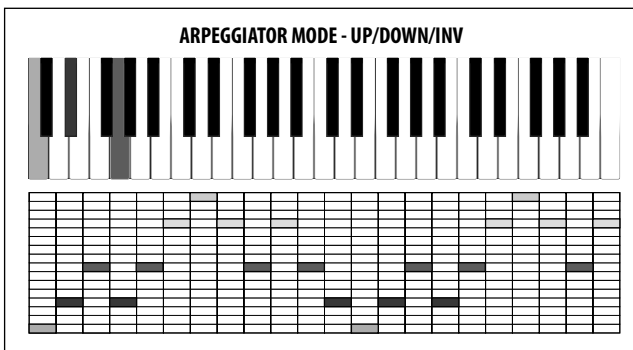

- **UP-ALT** - Notes are played as lowest, then highest, then next lowest, then next highest and so on until the notes have all been played. This is then repeated. There is no repetition at the highest and lowest notes.

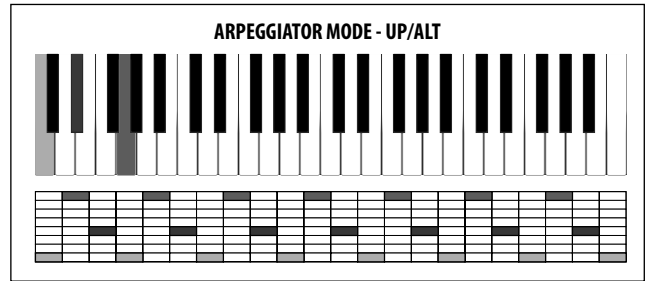

- **DOWN-ALT** - Notes are played as highest, then lowest, then next highest, then next lowest and so on until the notes have all been played. This is then repeated. There is no repetition at the highest and lowest notes.

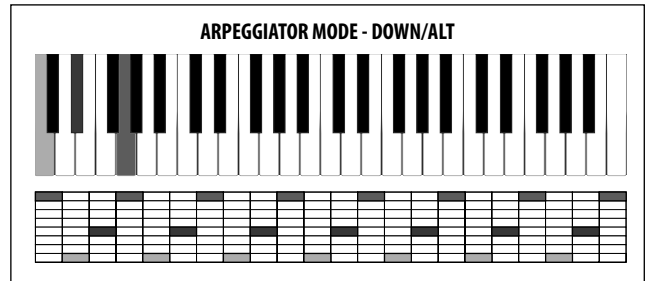

- **RAND** - The notes are played at random.

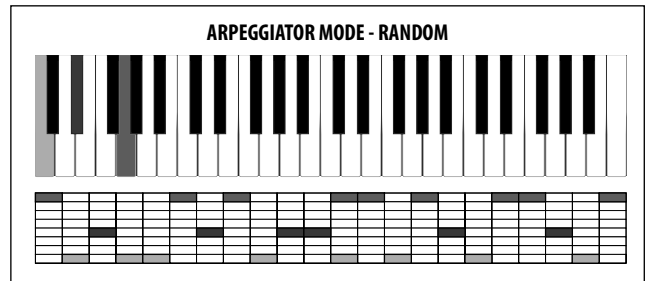

- **AS PLAYED** - The notes are played by the ARPEGGIATOR in the order that you play the notes. This is then repeated. There is no repetition at the highest and lowest notes.

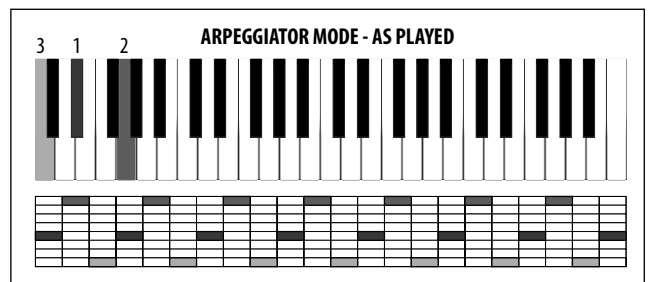

- **CHORD** -The notes are played together for each step of the ARPEGGIATOR.

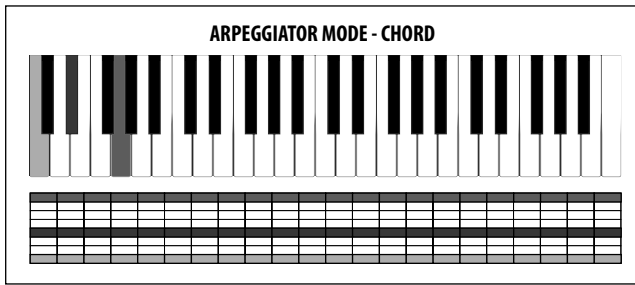

The default mode of the ARPEGGIATOR is **UP**.

**HOLD** - This option is the same as the HOLD switch on the surface when the ARPEGGIATOR is switched on. The switch will follow any changes made here, and changes on the surface will be reflected here. The default HOLD mode is OFF.

**CLOCK DIVIDER** - This option allows you divide the Master BPM in a number of ways to produce the ARPEGGIATOR CLOCK.

**Note:** When the SUSTAIN input is set to any of the GATE modes in the PEDAL SETTINGS the value will be replaced by "(Gate)" to indicate that the CLOCK DIVIDER is not used and the ARPEGGIATOR notes are controlled by the GATE input.

You can select one of the division modes from the list below:

Note: For a timing diagram please consult the section later in this document.

RATIO	DESCRIPTION
1/2	Half note
3/8	Dotted quarter note
1/3	Third note (Half note triplets)
1/4	Quarter note
3/16	Dotted eighth note
1/6	Sixth note(Quarter note triplets)
1/8	Eighth note
3/32	Dotted sixteenth note
1/12	Twelfth note (Eighth note triplets)
1/16	Sixteenth note
1/24	Twenty-fourth note (Sixteenth note triplets)
1/32	Thirty-second note
1/48	Forty-eighth note (Thirty-second note triplets)

The default value is 1/16 (sixteenth note).

**RATE(BPM)** - This option is the same as the RATE fader on the surface. Any changes on the surface will be reflected here.

The Master BPM RATE range is from 20.0 to 275.0 BPM. The default RATE value is 120.0 BPM.

**Note:** When the SUSTAIN input is set to any of the GATE modes in the PEDAL SETTINGS the value will be replaced by "(Gate)" to indicate that the RATE is not used and the ARPEGGIATOR notes are controlled by the GATE input.

**SWING** - This option allows you to adjust the swing (or groove) of the ARPEGGIATOR.

When applying SWING, every other step is delayed by an amount set by the swing value. The swing value represents the ratio of time between two steps. I.e. When the swing is at 50% there will be equal timing between the steps. When wanting to adjust the SWING timing to fall where a triplet would, you should set the SWING to 66%.

You can use the SWING parameter to add timing element which can help create propulsive rhythms, or laid back styles which can help give the sequence of notes movement, or allow it to breath, or make room for other parts of the mix.

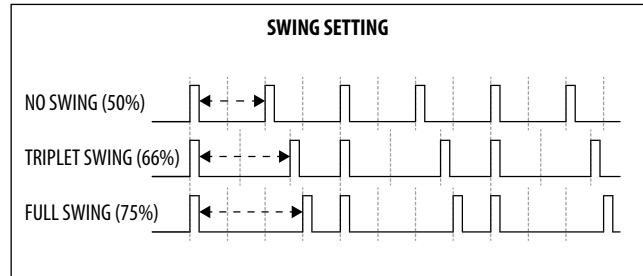

The SWING RATE range is from 50 to 75. The default SWING value is 50.

**Note:** When the SUSTAIN input is set to any of the GATE modes in the PEDAL SETTINGS the value will be replaced by "(Gate)" to indicate that the SWING is not used and the ARPEGGIATOR notes are controlled by the GATE input.

**PATTERN** - The ARPEGGIATOR has a looping PATTERN function which can dynamically control the VELOCITY and GATE TIME values for each step.

When the ARPEGGIATOR starts playing and a PATTERN is selected, the VELOCITY and GATE TIME values from the PATTERN editor will be applied to the notes of the ARPEGGIATOR. The PATTERN will continue to cycle while the ARPEGGIATOR is playing.

You can set the PATTERN LENGTH to match the ARPEGGIATOR notes, or use a different PATTERN LENGTH to create variations and movement. E.g. When using DOWN-INV 6 notes are played during each cycle of the ARPEGGIATOR. With a PATTERN LENGTH setting of 4, you will hear the pattern moving through the ARPEGGIATOR cycle.

The pattern editor has 32 fixed "Preset Patterns" allowing you to start using the patterns quickly and 32 "User Patterns" so that you can store your own unique patterns. The patterns can be up to 32 steps long allowing a large range of creative possibilities.

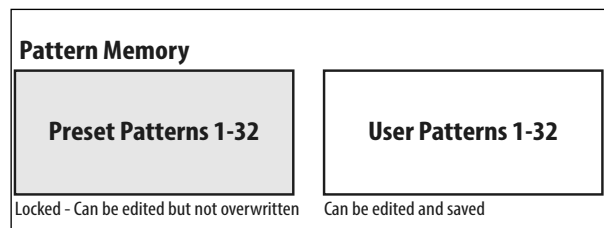

**ARP PATTERN SELECTION** - To select an ARPEGGIATOR PATTERN, make sure that the '<' symbol on the PATTERN line is highlighted. The default setting is Off, to select a PATTERN (Preset or User) use the rotary knob, or the fader.

EN

**ARP PATTERN EDITING** - To use the PATTERN EDITOR make sure that the '<' symbol on the PATTERN line is highlighted. Then press the +/YES switch and the PATTERN EDITOR will then be displayed.

If no PATTERN is selected it will look like this:

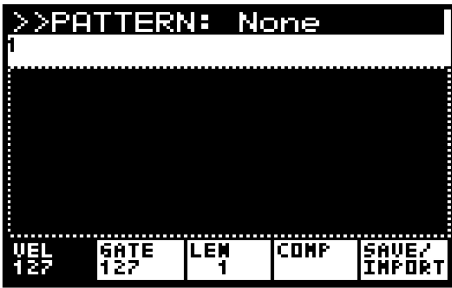

If a PATTERN is selected it will look something like this:

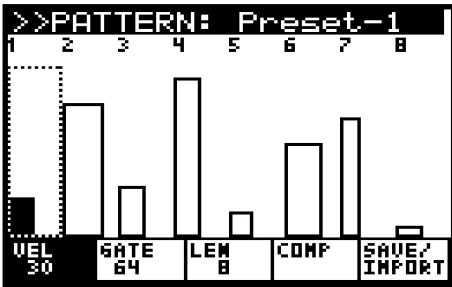

The controls for the PATTERN EDITOR are as follows:

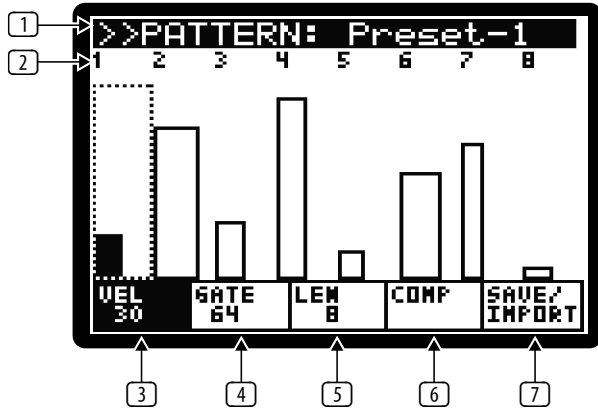

**Note:** The parameter being edited is selected using the switches directly under the tabs at the bottom of the screen.

- 1 **PATTERN NAME** - The PATTERN name is displayed at the top of the screen. The pattern can be changed by pressing the -NO/+YES switches.

**Note:** If a PATTERN is edited a \* will be displayed by its name to indicate that editing has been done and is not yet saved.

**Note:** Navigating away from edited pattern allows you to return to it without losing changes. However, if you begin to edit a different pattern, your edits to the original PATTERN will be lost.

- 2 **STEP INDICATORS** - The STEP values are shown at the top of the screen. The current step can be selected using the rotary knob, each click will move the selection forward or backward one step. The current step number is displayed in the header and the step is highlighted in black and indicated using a dotted rectangle.



**Note:** When the ARPEGGIATOR is ON and running, you will see a PATTERN POSITION POINTER (PPP) under the step being played. The PPP is a small black bar which is updated in real-time.



**Note:** To duplicate steps, start by selecting the step to duplicate, hold the PROG switch then navigate to the target step and release the PROG switch.

- 3 **VELOCITY** - The VELOCITY of each step is shown by the height of the bar within the step. To adjust the velocity for a step, press the PROG switch (under the VEL text) to enter VELOCITY editing mode. When you are in VELOCITY editing mode the virtual switch will be reversed (white on black).



The height of the bar indicates the current velocity setting.

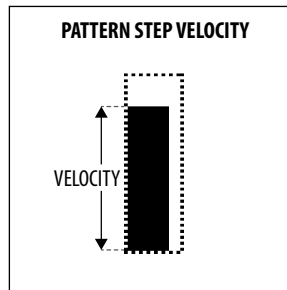

The VELOCITY for each step can then be changed by using the UP/DOWN switches or using the data entry fader.

- 4 **GATE** - The GATE TIME of each is shown by the width of the bar within each step. To adjust the GATE TIME for a step, press the FX switch (under the GATE text) to enter GATE TIME editing mode. When you are in GATE TIME editing mode the virtual switch will be reversed (white on black).



The GATE TIME for each step can then be changed by using the UP/DOWN switches or using the data entry fader.

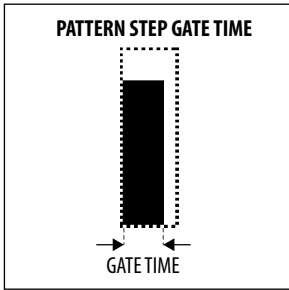

**Note:** To tie steps start by selecting the step you want to tie to the next one, hold the FX switch, then turn rotary knob clockwise. You can tie several steps together by continuing to rotate the rotary knob without having to release the FX switch. To remove the tie, select the note that is tied to previous, hold FX switch, turn rotary knob anti-clockwise. You can also do this with several steps in the same way as creating a tie.

**Note:** The GATE TIME FADER on the front panel, and the GATE TIME PARAMETER in the PATTERN EDITOR both affect the length of the notes.

With the GATE TIME FADER at maximum the note length matches the full length of the PATTERN GATE TIME.

With the GATE TIME fader is in the middle then the note length is half of the PATTERN GATE TIME.

- 5 **LENGTH** - To adjust the LENGTH of the pattern (the number of steps), press the GLOBAL switch (under the LEN text) to enter LENGTH editing mode. When you are in LENGTH editing mode the virtual switch will be reversed (white on black).



The LENGTH of the PATTERN can then be changed by using the UP/DOWN switches or using the data entry fader.

- 6 **COMP** - This switch allows you to COMPARE the current status of the PATTERN being edited against the stored PATTERN. To use the PATTERN COMPARE function, press the COMPARE switch (under the COMP text) to enter COMPARE mode. When you are in COMPARE mode the virtual switch will be reversed (white on black).

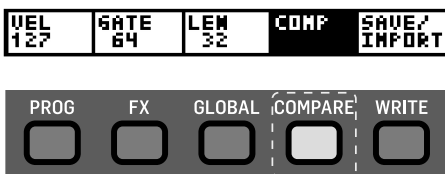

**Note:** The COMP switch is only available when a USER PATTERN is selected.

- 7 **SAVE/IMPORT** - This switch allows you to SAVE the current PATTERN, or IMPORT a PATTERN. When you press the WRITE switch (under the SAVE/IMPORT text) you will be presented with two options:

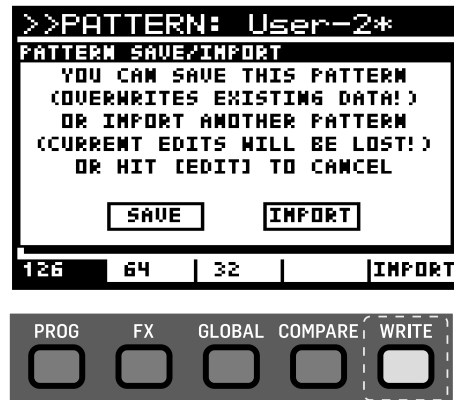

You can now use the -/NO and +/YES switches to select SAVE or IMPORT, or the EDIT ARP/SEQ switch to exit the dialog. All three switches will flash to show that they are the available options:

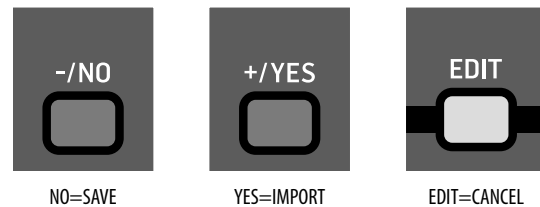

**SAVE** - This will save your edits into the currently selected location. This will overwrite the PATTERN stored in the current location.

**Note:** You can only SAVE into USER PATTERN locations, as the PRESET PATTERNS are protected.

**IMPORT** - Selecting IMPORT will open a read only version of the PATTERN EDITOR page, so that you can preview the pattern which will be imported into the current location. Parameters cannot be edited in this page.

To select a PATTERN to IMPORT use the -/NO and +/YES switches. To IMPORT a PATTERN press the WRITE switch (under the IMPORT text). To cancel the IMPORT, press the PROG switch (under the BACK text).

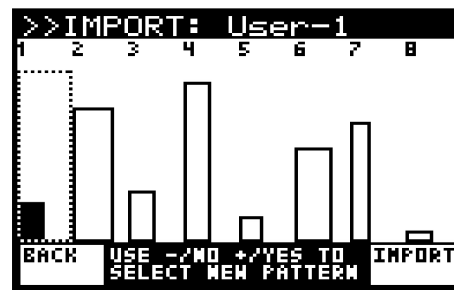

**CANCEL** - This will cancel the SAVE/IMPORT function and return you to the PATTERN EDITOR.

**Note:** The SAVE/IMPORT switch is only available when a USER PATTERN is selected.

**Note:** If you have edited a PATTERN and then go to select another PATTERN without saving your changes you will be presented with a warning message that unsaved edits will be lost. You can press +/YES to allow the change, or -/NO to cancel the change.

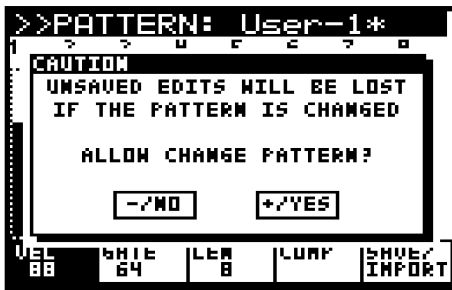

To exit the PATTERN page press the ARP/SEQ EDIT switch to return to the main ARPEGGIATOR/CONTROL SEQUENCE/SYNC SETTINGS menu.

To exit the ARPEGGIATOR/CONTROL SEQUENCE/SYNC SETTINGS menu press the EDIT switch again (or press the PROG switch) to return the main display.

### 8.1.8 EDIT CTRL SEQUENCER

The CONTROL SEQUENCER allows you to create a pattern which can be used to modulate other parameters. This section covers in detail all the parameters related to the CONTROL SEQUENCER.

For more information on using the CONTROL SEQUENCER as a modulation source please consult the MOD MATRIX section later in this document.

To enter the EDIT page for the ARPEGGIATOR & CONTROL SEQUENCER press the EDIT switch.

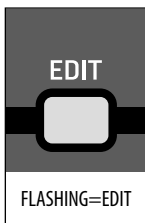

In the ARP/SEQ EDIT menu there are three pages, this section covers the CONTROL SEQUENCER menu. To cycle through the pages use consecutive presses of the EDIT switch. The bottom line of the screen will show guidance to the next page.

To access the CONTROL SEQUENCER menu directly you can press the ARP/SEQ EDIT switch twice. The CONTROL SEQUENCER menu is then shown:

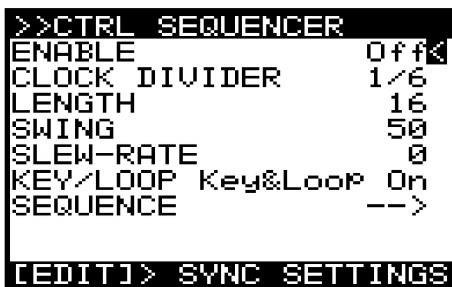

To navigate the options in the CONTROL SEQUENCER menu, use the UP, DOWN, switches.

Selected parameters are adjusted using the -NO/+YES switches, the rotary knob or the fader. The rotary knob has a click which allows very accurate control. The fader allows rapid adjustment across the full range.

**ENABLE** - This option turns the CONTROL SEQUENCER function On and Off.

**CLOCK DIVIDER** - This option allows you divide the Master BPM in a number of ways to produce the CONTROL SEQUENCER CLOCK. You can select any of the options from the following table:

**Note:** For a timing diagram please consult the section later in this document.

RATIO	DESCRIPTION
4	Four bars
3	Three bars
2	Two bars
1	One bar
1/2	Half note
3/8	Dotted quarter note
1/3	Third note (Half note triplets)
1/4	Quarter note
3/16	Dotted eighth note
1/6	Sixth note(Quarter note triplets)
1/8	Eighth note
3/32	Dotted sixteenth note
1/12	Twelfth note (Eighth note triplets)
1/16	Sixteenth note
3/64	Dotted thirty-second note
1/24	Twenty-fourth note (Sixteenth note triplets)
1/32	Thirty-second note
3/128	Dotted sixty-fourth note
1/48	Forty-eighth note (Thirty-second note triplets)
1/64	Sixty-fourth note

The default value is 1/16.

**Note:** When the SUSTAIN input is set to any of the GATE modes in the PEDAL SETTINGS the value will be replaced by "(Gate)" to indicate that the CLOCK DIVIDER is not used and the CONTROL SEQUENCER steps are controlled by the GATE input.

**LENGTH** - This option allows you to adjust the length (number of steps) of the CONTROL SEQUENCE. This can also be adjusted within the SEQUENCE EDITOR.

The default value is 6.

**SWING** - This option allows you to adjust the swing (or groove) of the CONTROL SEQUENCER.

When applying SWING, every other step is delayed by an amount set by the swing value. The swing value represents the ratio of time between two steps. I.e. When the swing is at 50% there will be equal timing between the steps. When wanting to adjust the SWING timing to fall where a triplet would, you should set the SWING to 66%.

You can use the SWING parameter to add timing element which can help create propulsive rhythms, or laid back styles which can help give the sequence of notes movement, or allow it to breath, or make room for other parts of the mix.

The SWING RATE range is from 50 to 75. The default SWING value is 50.

**Note:** When the SUSTAIN input is set to any of the GATE modes in the PEDAL SETTINGS the value will be replaced by "(Gate)" to indicate that the SWING is not used and the CONTROL SEQUENCER steps are controlled by the GATE input.

**SLEW-RATE** - This option allows you to adjust the SLEW RATE of the CONTROL SEQUENCER. The SLEW RATE is the rate at which the value changes from one step to the next. With a high slew rate you will get a sloped transition between steps, and with a SLEW RATE of 0, you will get an instantaneous change from one step to the next.

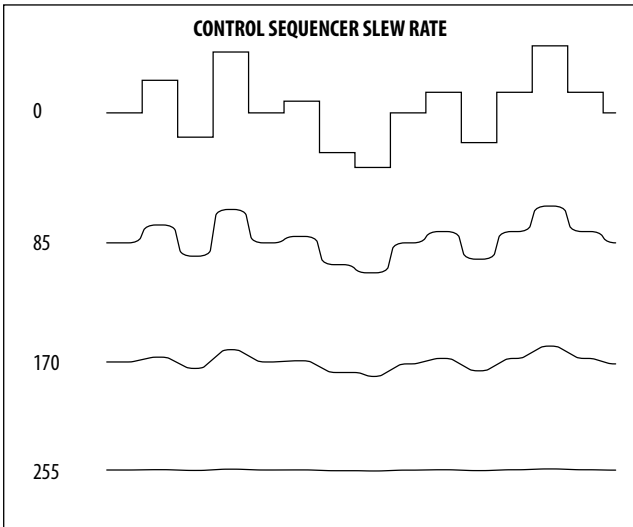

The SLEW RATE range is from 0-255, with 0 being no change and 255 full smoothing.

The default SLEW RATE setting is 0.

**KEY/LOOP** - The KEY/LOOP mode controls how the CONTROL SEQUENCER looping and key synchronisation operate. The choices are as follows:

- **Loop On** - This option makes the CONTROL SEQUENCE loop continuously but does not restart when keys are pressed. This mode is useful when using the CONTROL SEQUENCER in conjunction with the ARPEGGIATOR and the SEQUENCE LENGTH is longer than the ARPEGGIATOR CLOCK DIVIDER.
- **Key Sync On** - This option will force the SEQUENCE to restart when a key is pressed. Note in this mode the CONTROL SEQUENCER will not loop.
- **Key&Loop On** - This option makes the CONTROL SEQUENCE loop continuously and also forces a reset when keys are pressed.

**SEQUENCE EDITING** - To use the SEQUENCE EDITOR make sure that the '<' symbol on the SEQUENCE line is highlighted. Then press the +/YES switch and the SEQUENCE EDITOR will then be displayed:

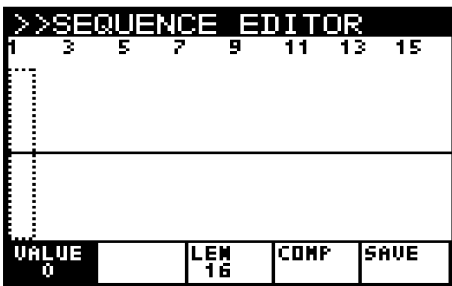

The controls for the SEQUENCE EDITOR are as follows:

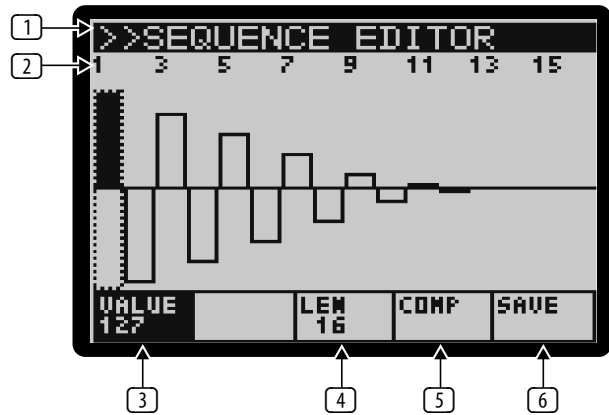

**Note:** The parameter being edited is selected using the switches directly under the tabs at the bottom of the screen.

- 1 **TITLE** - The top bar shows the text "SEQUENCE EDITOR".
- 2 **STEP INDICATORS** - The STEP values are shown at the top of the screen. The current step can be selected using the rotary knob, each click will move the selection forward or backward one step. The current step number is displayed in header and the step is highlighted in black and indicated using a dotted rectangle.



**Note:** When the CONTROL SEQUENCER is ON and running, you will see a SEQUENCE POSITION POINTER (SPP) under the step being played. The SPP is a small black bar which is updated in real-time.



**Note:** To duplicate steps start by selecting the step to duplicate, hold the PROG switch, then navigate to target step and release the PROG switch.

- 3 **VALUE** - The VALUE of each step is shown by the height of the bar within the step. To adjust the value for a step, press the PROG switch (under the VALUE text) to enter VALUE editing mode. When you are in VALUE editing mode the virtual switch will be reversed (white on black).



The height of the bar indicates the current value setting.

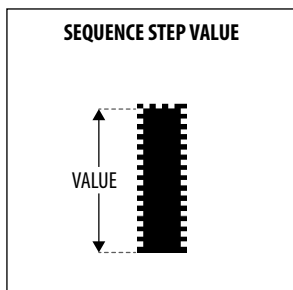

The VALUE for each step can then be changed by using the UP/DOWN switches or using the data entry fader.

- 4 **LENGTH** - To adjust the LENGTH of the SEQUENCE (the number of steps), press the GLOBAL switch (under the LEN text) to enter LENGTH editing mode. When you are in LENGTH editing mode the virtual switch will be reversed (white on black).

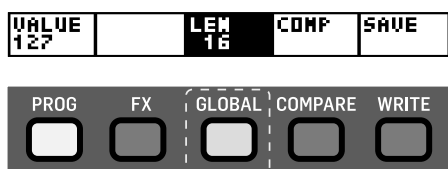

The LENGTH of the SEQUENCE can then be changed by using the UP/DOWN switches or using the data entry fader.

- 5 **COMP** - This switch allows you to COMPARE the current status of the SEQUENCE being edited against the stored SEQUENCE. To use the SEQUENCE COMPARE function, press the COMPARE switch (under the COMP text) to enter COMPARE mode. When you are in COMPARE mode the virtual switch will be reversed (white on black).

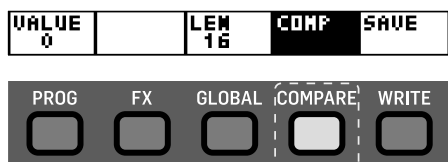

- 6 **SAVE** - This switch takes you to the WRITE PROGRAM dialog (i.e. the normal use of the WRITE switch).

To exit this menu press the ARP/SEQ EDIT switch to return to the main ARPEGGIATOR/CONTROL SEQUENCE/ARP SETTINGS menu.

To exit the ARPEGGIATOR/CONTROL SEQUENCE/ARP SETTINGS menu press the EDIT switch twice, (cycling past the ARP SETTINGS menu to exit), or press the PROG switch to return the main display.

## 8.1.9 ARP SETTINGS

To access the ARP SETTING menu directly you can press the ARP/SEQ EDIT switch three times. The ARP SETTINGS menu is then shown



To navigate the options in the SYNC SETTINGS menu, use the UP, DOWN, switches.

Selected parameters are adjusted using the -NO/+YES switches, the rotary knob or the fader. The rotary knob has a click which allows very accurate control. The fader allows rapid adjustment across the full range

**CLOCK** - This option allows you to select the Master BPM clock source for the DeepMind 12 ARPEGGIATOR, CONTROL SEQUENCER, LFOs, ENVELOPES and certain time based FX parameters.

- **Internal** - The Master BPM clock is generated internally and uses the RATE fader to control the tempo.
- **MIDI (Auto)** - The Master BPM clock is sourced from the MIDI IN socket and uses the RATE fader to control the CLOCK DIVIDER. If no MIDI clock is present at the MIDI IN socket, the DeepMind 12 will AUTO revert to the internally generated clock.
- **USB Auto** - The Master BPM clock is sourced from the USB port and uses the RATE fader to control the CLOCK DIVIDER. If no MIDI clock is present at the USB port, the DeepMind 12 will AUTO revert to the internally generated clock.

The default CLOCK setting is MIDI(Auto).

**ARP-TO-MIDI** - This option sends the notes played by the ARPEGGIATOR to all MIDI sources. This allows you to record the ARPEGGIATOR note sequence.

The default ARP-TO-MIDI setting is Off.

**Note:** When an external source (MIDI or USB) is used you can nudge the sync point back and forward by using the -NO/+YES switches when "ARP RATE" is selected in the ARPEGGIATOR menu. This allows you to offset the synchronisation if required when working with other hardware/software and associated latencies.

**Note:** Please ensure that you do not create any MIDI loops in your DAW MIDI routing, as feeding back the ARPEGGIATOR notes will cause unpredictable results.

**ARP-PARAMS** - This option controls how the ARPEGGIATOR is linked.

- **PROGRAM** - In this mode the ARPEGGIATOR is stored with the program.
- **GLOBAL** - In this mode the ARPEGGIATOR keeps its current settings and status even when you change programs. This can be useful for creating a sequence and then browsing programs while the ARPEGGIATOR continues to play the same notes/pattern/sequence.

**Note:** The CONTROL SEQUENCER remains unaffected by this option.

**Note:** When switching from GLOBAL to PROGRAM mode, the current settings are preserved and are used in place of the settings contained in the selected program.

To exit the ARPEGGIATOR/CONTROL SEQUENCE/ARP SETTINGS menu press the EDIT switch again (or press the PROG switch) to return the main display.



## 8.2 LFO (1&2)

**Note:** The operation of LFO1 and LFO2 is identical and therefore only described once in this section.

The Low Frequency Oscillator (LFO) creates signals which are used to modulate or control other parameters. LFOs are traditionally used to add vibrato by modulating the pitch, tremolo by modulating the amplitude or a ripple effect by modulating the filter cut off frequency. The DeepMind 12 LFO uses traditional shapes such as sinusoidal and ramping, but also offers advanced LFO shapes such as sample and hold, and sample and glide.

The LFOs are also MOD MATRIX sources and can be applied to any of 130 destinations allowing for a huge amount of options to enhance your sound design.

The LFOs can also be used to trigger any of the ENVELOPES, for more detail please consult the ENVELOPE section later in this document.

The DeepMind 12 offers an LFO speed which can reach into audio frequencies, opening another door to creative modulation possibilities.

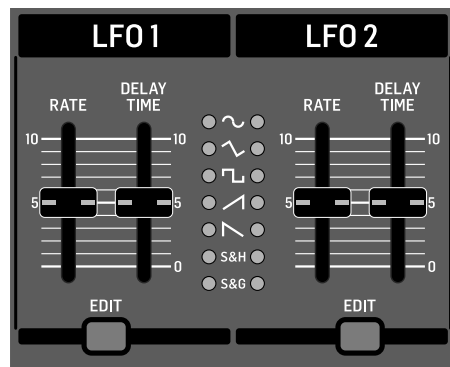

### 8.2.1 LFO RATE FADER

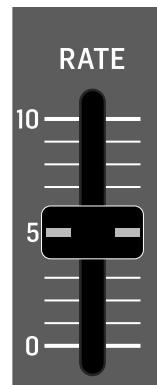

The LFO RATE fader controls the speed of the LFO.

Decreasing the value will make the LFO RATE slower, and increasing the value will make the LFO RATE faster as shown below:

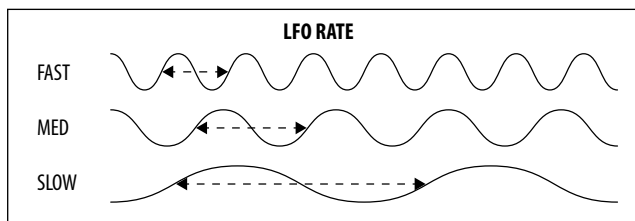

The LFO RATE range is from 0 to 255, with 0 being 0.041 Hz (24.1 s) and 255 being 65.4 Hz (15.3 ms) The default LFO RATE value is 0.

**Note:** The LFO RATE can extend beyond the rate set by the fader when the LFO1 RATE MOD MATRIX DESTINATION is modulated by a MOD MATRIX SOURCE. The maximum rate when controlled via the MOD MATRIX is 1280 Hz. When the NOTE NUMBER is used as the source for modulation you can create cross modulation type effects.

**Note:** When the ARP-SYNC is on, the LFO RATE fader no longer controls the RATE directly but chooses a time division of the Master BPM RATE as described in the EDIT LFO section.

The fader position, current value and stored value for the LFO RATE fader is shown on the PROG screen. There is also a visualization of the waveform as shown below:

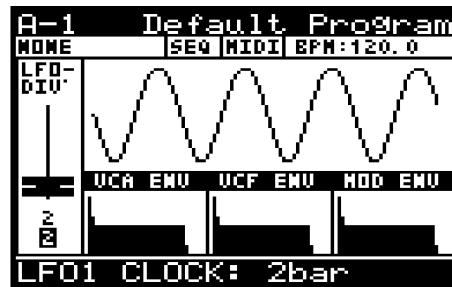

### 8.2.2 LFO DELAY TIME FADER

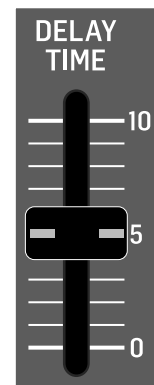

The DELAY TIME fader controls the amount of delay before the LFO starts.

When the LFO waveform starts it is faded in over a period of time. If you think of the time to reach the full LFO waveform as 100%, then 40% of that time is used for the delay period where no waveform is produced and 60% of that time is used for the fade duration.

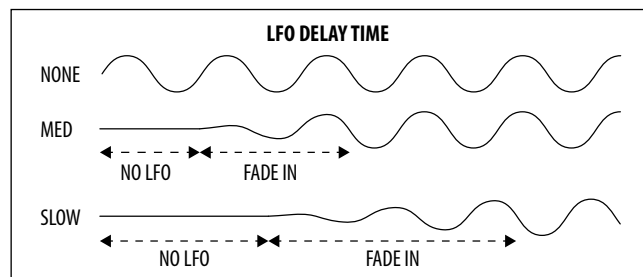

The DELAY TIME range is from 0.00s to 6.59s. The default DELAY TIME value is 0.00s.

EN

The fader position, current value and stored value for the LFO DELAY TIME fader is shown on the PROG screen. There is also a visualization of the waveform as shown below:

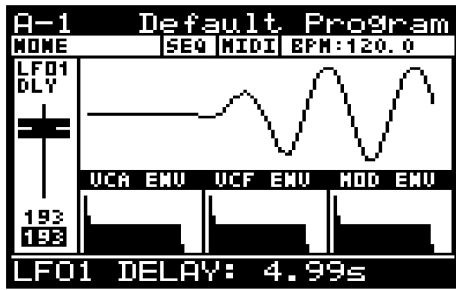

### 8.2.3 LFO WAVEFORMS INDICATORS

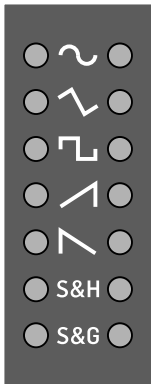

The LFO waveform shape setting is always shown on the LEDs.

The LFO waveform shape in use will have an illuminated LED next to it.

The LED will glow to show the status of the waveform as shown below:

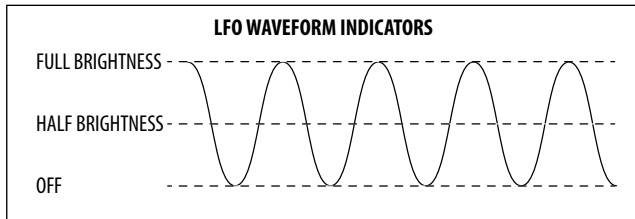

### 8.2.4 LFO EDIT MENU

To access the LFO EDIT menu press the LFO EDIT switch.

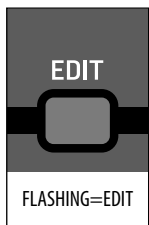

**Shortcut Note:** To change the LFO waveform shape press and hold the LFO EDIT switch. While holding the switch you can use the LFO RATE fader to set the LFO waveform shape.

The LFO EDIT switch will then start flashing and the LFO EDIT menu is then shown:

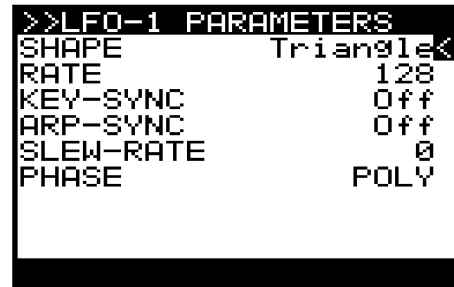

To navigate the options in the LFO EDIT menu, use the UP, DOWN, switches.

Selected parameters are adjusted using the -NO/+YES switches, the rotary knob or the fader. The rotary knob has a click which allows very accurate control. The fader allows rapid adjustment across the full range .

**SHAPE** - This option allows you to select one of the waveform shapes from the following options (shown with their respective visualization waveforms from the PROG display).

**Sine** - A mathematically correct sinusoidal waveform.



**Triangle** - A symmetrical triangular waveform.



**Square** - A symmetrical square waveform.



**Ramp Up** - An up ramping triangular waveform.

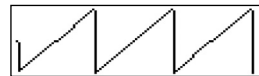

**Ramp Down** - An up ramping triangular waveform.

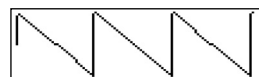

**Smp&Hold (Sample and Hold)** - A random stepped waveform which transitions instantly from step to step.

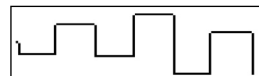

**Smp&Glide (Sample and Glide)** - A random stepped waveform which glides from step to step.

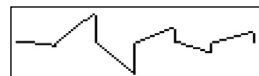

The default LFO SHAPE setting is Triangle.

**RATE** - This option is the same as the LFO RATE fader on the surface. Any changes on the surface will be reflected here.

The LFO RATE range is from 0 to 255, with 0 being 0.05371 Hz (18.6 s) and 255 being 85 Hz The default LFO RATE setting is 0.

**Note:** When the ARP-SYNC is ON, the RATE parameter is not shown, but CLOCK-DIVIDE instead. This shows values based on time division of the Master BPM RATE as shown below:

**Note:** For a timing diagram please consult the section later in this document.

4	Four bars
3	Three bars
2	Two bars
1	One bar
1/2	Half note
3/8	Dotted quarter note
1/3	Third note (Half note triplets)
1/4	Quarter note
3/16	Dotted eighth note
1/6	Sixth note(Quarter note triplets)
1/8	Eighth note
3/32	Dotted sixteenth note
1/12	Twelfth note (Eighth note triplets)
1/16	Sixteenth note
3/64	Dotted thirty-second note
1/24	Twenty-fourth note (Sixteenth note triplets)
1/32	Thirty-second note
3/128	Dotted sixty-fourth note
1/48	Forty-eighth note (Thirty-second note triplets)
1/64	Sixty-fourth note

**KEY SYNC** - This option allows you to turn KEY-SYNC (Key Synchronisation) On and Off. When KEY-SYNC is On, the LFO waveform generation will be reset as you strike a note (keeping in mind the LFO DELAY TIME is also part of the waveform generation). When KEY-SYNC is Off, the LFO will free run.

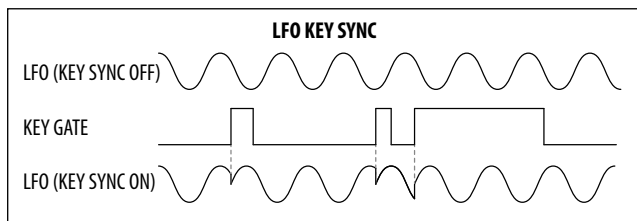

The default KEY-SYNC setting is Off.

**ARP SYNC** - This option allows you to turn ARP-SYNC (Arpeggiator Synchronisation) On and Off. When ARP-SYNC is On, the LFO waveform will synchronize to the Master BPM. When ARP-SYNC is off the LFO will run at the rate set by the LFO RATE fader/parameter.

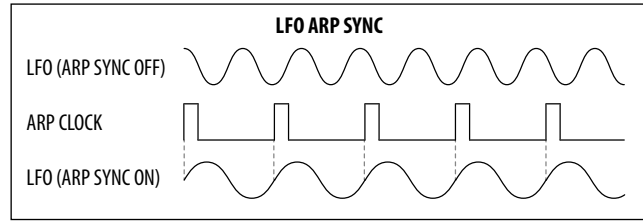

The default ARP-SYNC setting is Off.

**SLEW-RATE** - This option allows you to smooth out the transitions of the LFO waveform. The SLEW RATE reduces the rate of change of the LFO waveform shape.

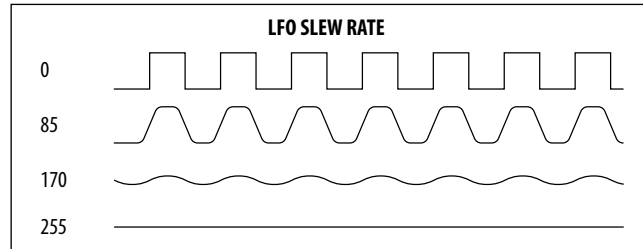

The SLEW RATE range is from 0-255, with 0 being no change and 255 full smoothing.

The default SLEW RATE setting is 0.

**PHASE** - As each voice has independent LFOs, this option allows you to control the phase relationship between the LFO waveforms.

- **POLY** - All voices use an independent LFO. This is the default mode.
- **MONO** - All voices use a common LFO.
- **SPREAD** - With a setting of 1 there is a 1 degree shift between the LFOs for each voice. As you begin to increase the SPREAD value the phase of the LFO for each consecutive voice will be shifted by the amount of SPREAD applied. I.e. with a 90 degree setting, the first voice will always be at 0 degrees, and each consecutive voice will be shifted by an additional 90 degrees. So with 4 voice UNISON, voice 1 would be at 0 degrees, voice 2 would be at 90 degrees, voice 3 would be at 180 degrees and voice 4 would be at 270 degrees.

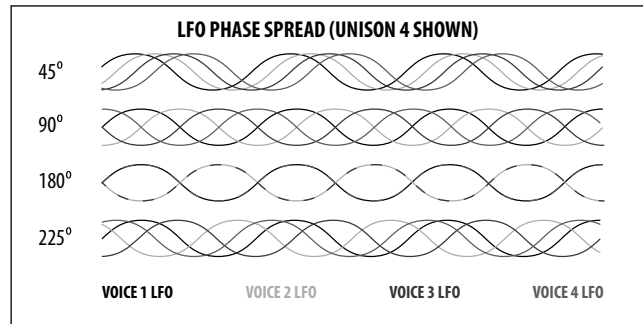

The PHASE range is from 1-254 degrees.

The default PHASE setting is POLY.

To exit the LFO EDIT menu press the EDIT switch again (or press the PROG switch). to return the main display.

### 8.3 OSC

The Oscillators (OSCs) have a completely analog implementation. The signal path of the waveform is purely analog circuitry. The pitch of these analog oscillators is controlled digitally to ensure superior tuning accuracy and stability across the entire range of playable notes.

**OSC 1** - This dual oscillator generates two different waveforms - one SAWTOOTH, and one SQUARE. The waveforms can be used independently or together to create harmonically rich content.

Features include pitch modulation of both the sawtooth and square waveforms, and pulse width modulation of the square waveform.

**OSC 2** - This single oscillator generates a SQUARE waveform.

Features include pitch offset, independent level control, pitch modulation and tone control modulation of the square waveform.

**NOISE** - This generates a NOISE waveform. The NOISE generator is a completely analog implementation and produces pink noise with a gentle roll off of lower frequencies.

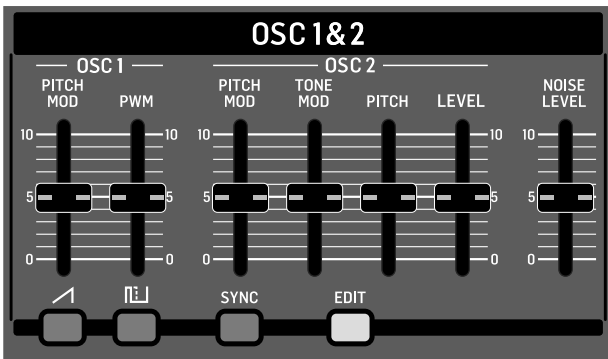

#### 8.3.1 OSC 1 PITCH MOD FADER

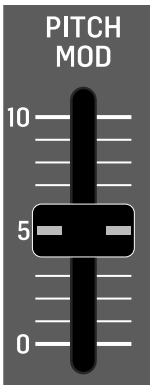

The OSC 1 PITCH MOD fader controls the amount of PITCH MODULATION applied to the OSC1 waveforms. The PITCH MODULATION SOURCE is selected in the OSC EDIT page described later in this section. Pitch modulation is often used to create a vibrato effect, but can be used in many other ways. The range of modulation is very wide, allowing both traditional and creative modulations.

Controlling the frequency using an external signal is a form of frequency modulation (FM), however as FM is more commonly used to describe the use of an audio oscillator modulating another audio oscillator the use of the term PITCH MODULATION is preferred in this instance.

**Note:** Because the DeepMind 12 LFO can reach well into the audio range (1280 Hz) it is possible to create traditional frequency modulation (FM) when the LFO is used as the source for PITCH MODULATION of the OSCs.

The diagram below shows the waveforms obtained with LFO control of OSC 1:

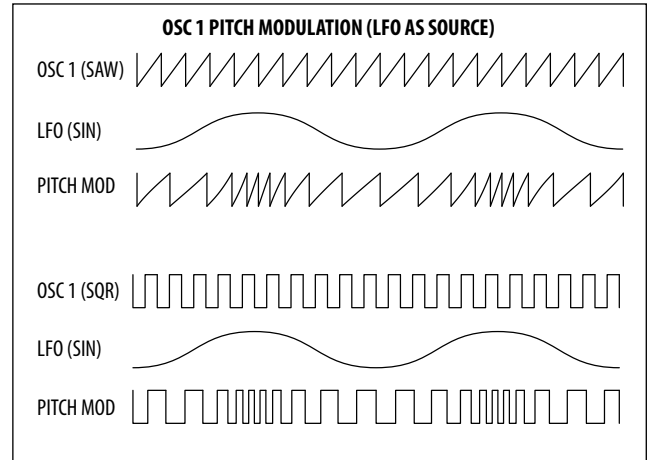

As you increase the amount of PITCH MODULATION the variance in the pitch of oscillator will increase resulting in larger increases and decreases as demonstrated in the diagram below. The PITCH MODULATION will affect both the SAWTOOTH and SQUARE waveforms produced by OSC 1.

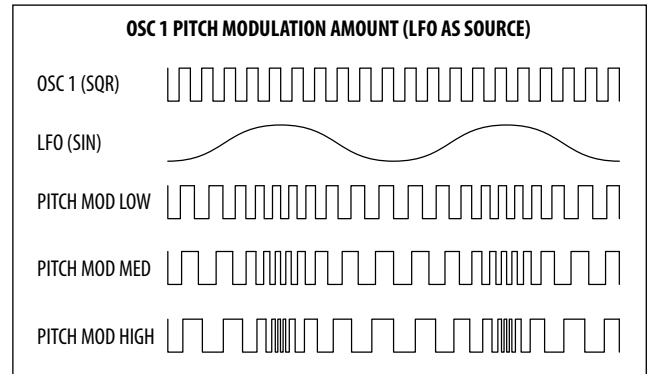

The OSC 1 PITCH MOD range is from 0.00cents to 36.0 semitones. The default OSC 1 PITCH MOD setting is 0.00cents.

The OSC 1 PITCH MOD fader has a non-linear response which gives more resolution at smaller settings, to allow delicate or fine use of the modulation. The response of the OSC 1 PITCH MOD fader is shown below:

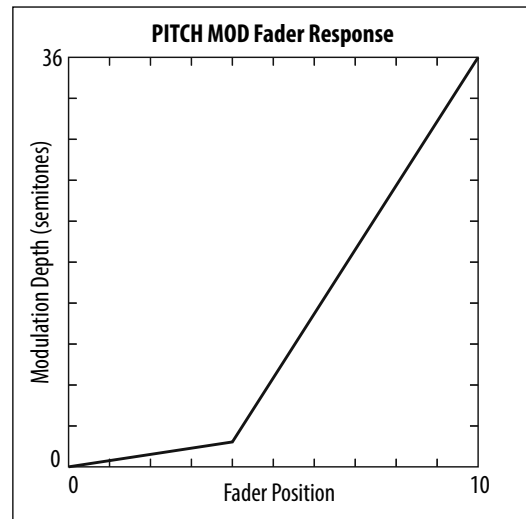

The fader position, current value and stored value for the OSC 1 PITCH MOD fader is shown on the PROG screen. There is also a visualization of the modulation as shown below. The arrows indicate the polarity of the modulation..

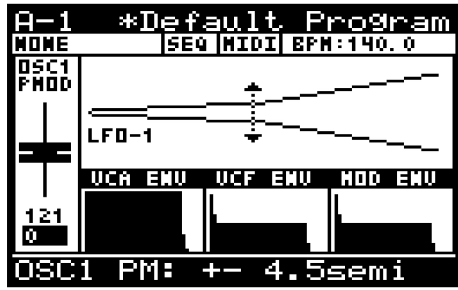

**Note:** for ENVELOPE sources the arrow will only point in the UP direction indicating that the modulation will be positive from the base pitch.

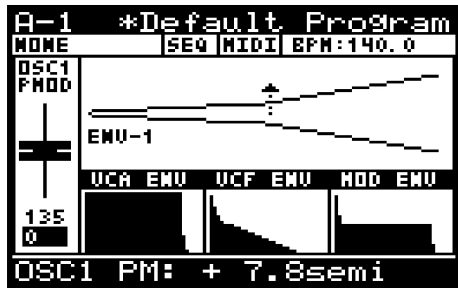

**Note:** for Uni-polar LFO sources the arrow will only point in the UP direction indicating that the modulation will be positive from the base pitch.

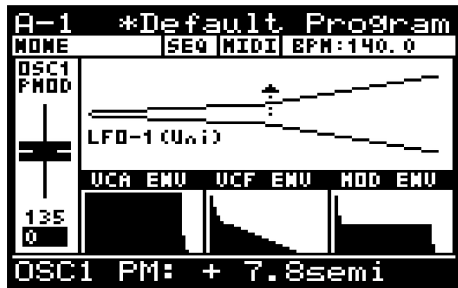

The default source for the pitch modulation is LFO1. For more information on selecting the OSC 1 pitch modulation source please consult the section later in this document.

### 8.3.2 OSC 1 PWM FADER

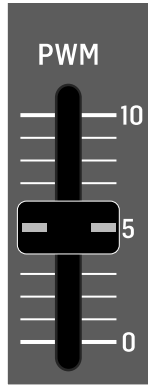

The OSC 1 PWM fader controls the PULSE WIDTH of the OSC 1 SQUARE waveform, or the depth of PULSE WIDTH MODULATION (PWM) applied to the OSC1 SQUARE waveform. The PWM SOURCE is selected in the OSC EDIT page described later in this section. When the PWM source is set to MANUAL, the fader controls the PULSE WIDTH. When the PWM source is set to any of modulation sources the fader controls the depth of PULSE WIDTH MODULATION.

PWM adds harmonic structure to the sound and is often used to create a phasing/movement effect, or used when creating string type sounds and sonic drones.

The pulse wave (aka rectangle wave) is often described as more "narrow sounding" than a fully symmetrical square wave. As the pulse width modulation is increased the "thinner" or "more hollow" the sound will become. Very high values of PWM played at very low frequencies will start to sound like clicks, pops or thumps.

As you increase the PULSE WIDTH the ratio of the positive cycle to the negative cycle (also jointly known as duty cycle) will increase. The PULSE WIDTH MODULATION does not affect the SAWTOOTH waveform.

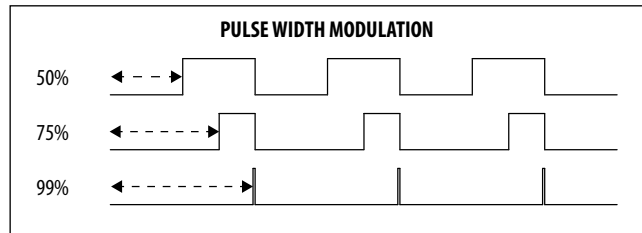

The OSC 1 PWM range is from 50.0% (symmetrical square-wave) to 99.0% (short pulsewave). The default OSC 1 PWM setting is 50.0%.

With a PULSE wave, the harmonic content changes depending on the pulse width. It is characterized by a lack of the nth harmonic series when the pulse width is 1/n. The example below does not have 3rd, 6th, or 9th harmonics because the pulse width is 1/3 (33%).

The characteristics of the PULSE waveform are shown below:

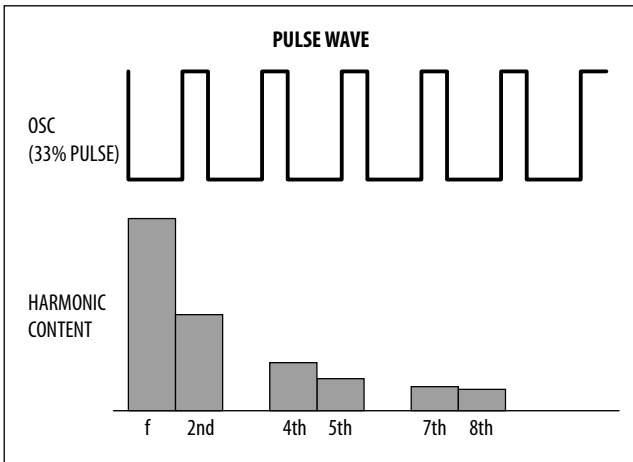

The fader position, current value and stored value for the OSC 1 PWM fader is shown on the PROG screen. There is also a visualization of the modulation as shown below.

**Note:** Whenever two waveforms are shown, the top waveform represents the summed output of the OSCs and the bottom waveform shows the parameter being adjusted.

The summed output shows 4 cycles and the parameter being adjusted shows a single cycle allowing you to see the detail of the changes you are making while adjusting the parameter.

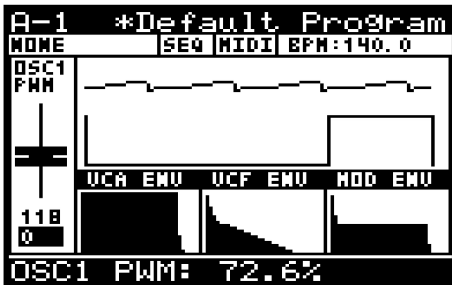

**Note:** When an LFO is used as a PWM source, the arrows indicate the range of modulation as shown below. In this mode the PWM fader is used to adjust the amount of modulation from 0 to +/- 49%..

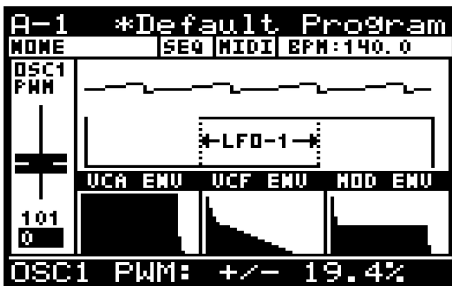

**Note:** When an ENVELOPE is used as a PWM source, the arrows indicate the range of modulation as shown below. In this mode the PWM fader is used to adjust the amount of modulation from 0 to +/- 49%..

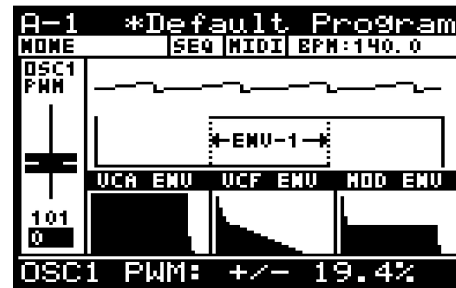

### 8.3.3 SAWTOOTH WAVEFORM SWITCH

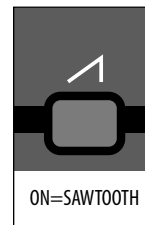

This switch controls the SAWTOOTH waveform output for OSC 1.

The SAWTOOTH waveform has a rasping, buzzy and hard sound. Classic synthesizer basses, strings, brass and pad sounds are often created using sawtooth waveforms. The large range of harmonic content makes the SAWTOOTH waveform a good candidate to start with when creating a program that you want to sound "fat".

The SAWTOOTH waveform contains a fundamental sine wave and all of its integral harmonic sine waves at a fixed ratio.

The characteristics of the SAWTOOTH waveform are shown below:

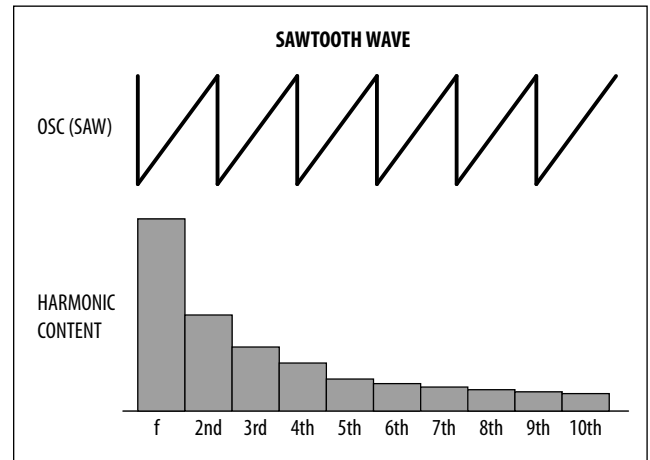

The SAWTOOTH waveform output can be On/Off. The default program setting is On.

**Note:** The OSC 1 SAWTOOTH waveform output can be used independently or in combination with the OSC 1 SQUARE waveform output.

There is also a visualization of the SAWTOOTH waveform as shown below:

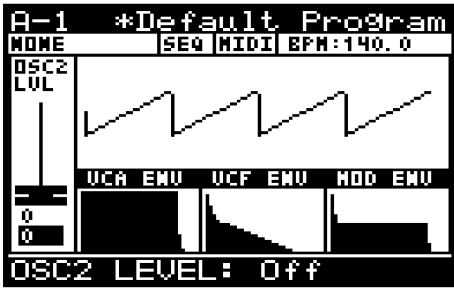

**Note:** The OSC 1 SQUARE waveform output can be used independently or in combination with the OSC 1 SAWTOOTH waveform output.

There is also a visualization of the SQUARE waveform as shown below:

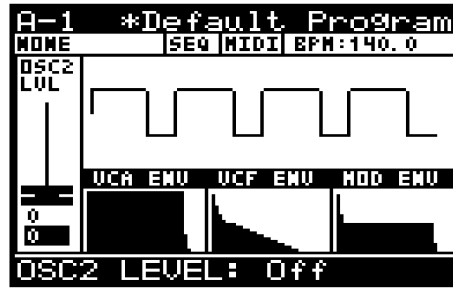

### 8.3.4 SQUARE WAVEFORM SWITCH

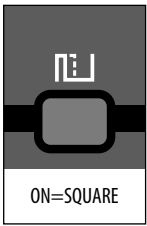

This switch controls the SQUARE waveform output for OSC 1.

The SQUARE waveform has a hollow sound, which does not sound as rich as a sawtooth waveform due to the lack of even harmonics. Traditionally it is often used to emulate a clarinet because of its similarity to the output of the instrument. However in modern electronic music it is commonly used to thin, nasal or cavernous sounds.

The SQUARE waveform contains a fundamental sine wave and its odd numbered harmonics at a fixed ratio. The level of each harmonic is the same as sawtooth wave. I.e. the content of nth harmonic is 1/n, except there are no even numbered harmonics present.

The characteristics of the SQUARE waveform are shown below:

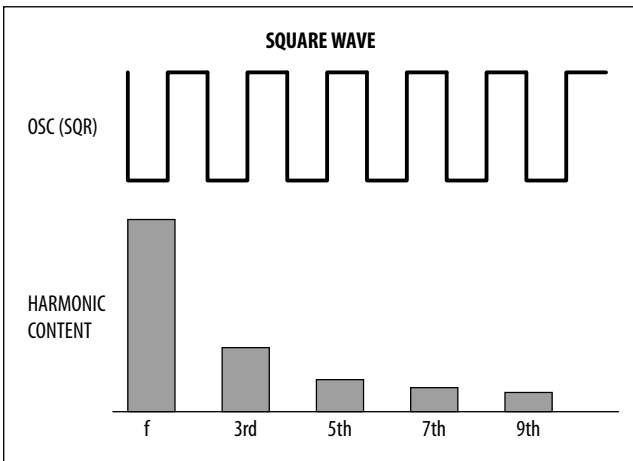

The SQUARE waveform output can be On/Off. The default program setting is On.

### 8.3.5 OSC 2 PITCH MOD FADER

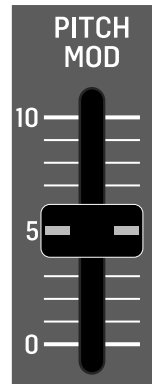

The OSC 2 PITCH MOD fader controls the amount of PITCH MODULATION applied to the OSC 2 SQUARE waveform. The PITCH MODULATION SOURCE is selected in the OSC EDIT page described later in this section. Pitch modulation is often used to create a vibrato effect, but can be used in many other ways. The range of modulation is very wide, allowing both traditional and creative modulations.

Controlling the frequency using an external signal is a form of frequency modulation (FM), however as FM is more commonly used to describe the use of an audio oscillator modulating another audio oscillator the use of an LFO signal the term PITCH MODULATION is preferred in this instance.

**Note:** Because the DeepMind 12 LFO can reach well into the audio range (1280 Hz) it is possible to create traditional frequency modulation (FM) when the LFO is used as the source for PITCH MODULATION of the OSCs

The diagram below shows the waveforms obtained with LFO control of OSC 2.

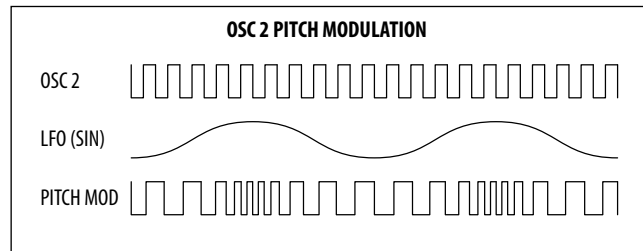

**EN**

As you increase the amount of PITCH MODULATION the variance in the pitch of oscillator will increase resulting in larger increases and decreases as demonstrated in the diagram below:.

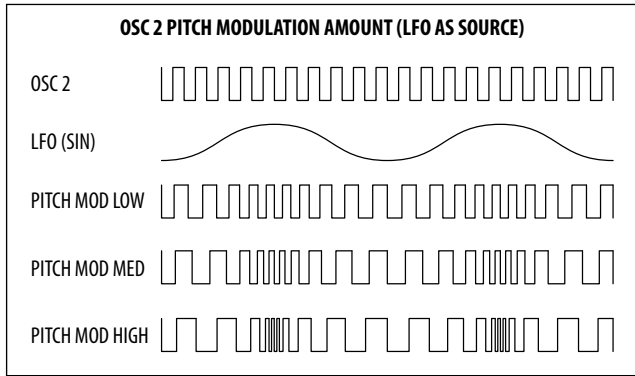

The OSC 2 PITCH MOD range is from 0.00cents to 36.0 semitones. The default OSC 2 PITCH MOD setting is 0.00cents.

The OSC 2 PITCH MOD fader has a non-linear response which gives more resolution at smaller settings, to allow delicate or fine use of the modulation. The response of the OSC 2 PITCH MOD fader is shown below:

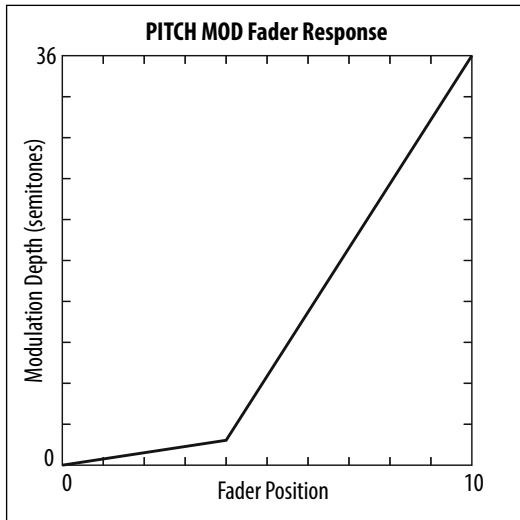

The fader position, current value and stored value for the OSC 2 PITCH MOD fader is shown on the PROG screen. There is also a visualization of the waveform as shown below. The arrows indicate the polarity of the waveform.

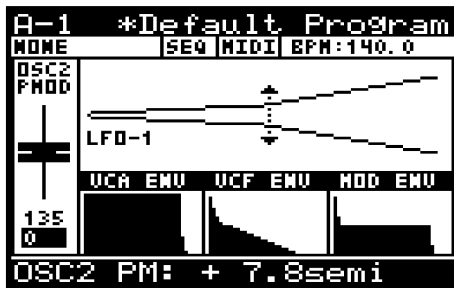

**Note:** for ENVELOPE sources the arrow will only point in the UP direction indicating that the base modulation will be positive from the base pitch.

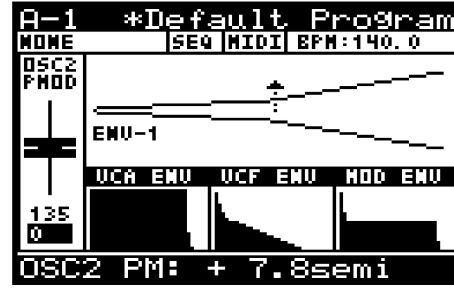

**Note:** for Uni-polar LFO sources the arrow will only point in the UP direction indicating that the base modulation will be positive from the base pitch.

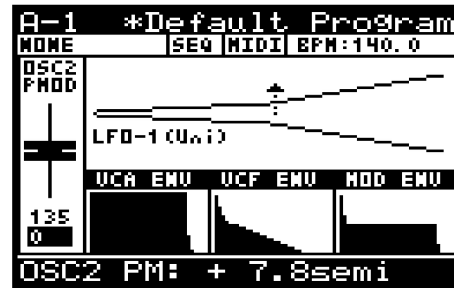

The default source for the pitch modulation is LFO1. For more information on selecting the OSC 1 pitch modulation source please consult the section later in this document.

**8.3.6 OSC 2 TONE MOD FADER**

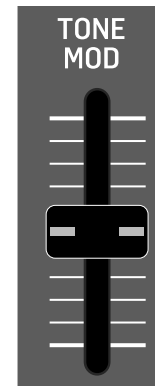

The OSC 2 TONE MOD fader controls the TONE MODULATION of the OSC 2 SQUARE waveform, The TONE MOD SOURCE is selected in the OSC EDIT page described later in this section. When the TONE MOD source is set to MANUAL, the fader controls the TONE MODULATION. When the TONE MOD source is set to any of the modulation sources the fader controls the depth of TONE MODULATION.

TONE MODULATION can be used in many ways e.g. to create a double phasing effect, or used when creating complex string type sounds. The harmonic structure of the OSC changes considerably when using TONE MODULATION, and the results can often have a metallic quality.



As you increase the amount of TONE MODULATION the positive and negative parts of the cycle are split by a pulse. The further you increase the fader, the width of the pulse increases.

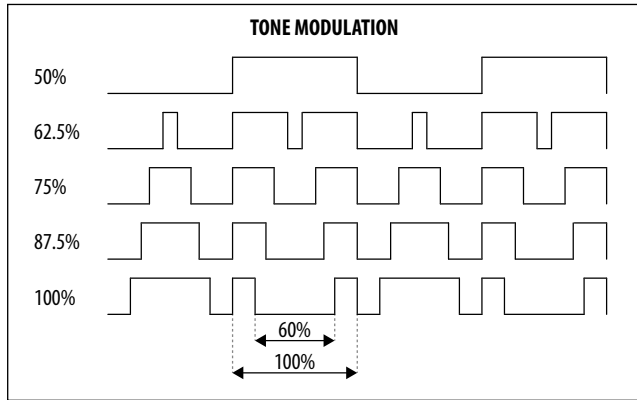

The TONE MOD range is from 50% (symmetrical square-wave) to 100% (pulse interrupt is 60% of half cycle). The default TONE MOD setting is 50%.

The fader position, current value and stored value for the TONE MOD fader is shown on the PROG screen. There is also a visualization of the waveform as shown below

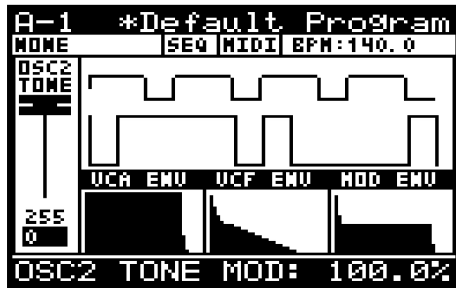

**Note:** for ENVELOPE sources the arrow will only point in the UP direction indicating the range of modulation. In this mode the TONE MOD fader is used to adjust the amount of modulation from 0 to +/- 49%

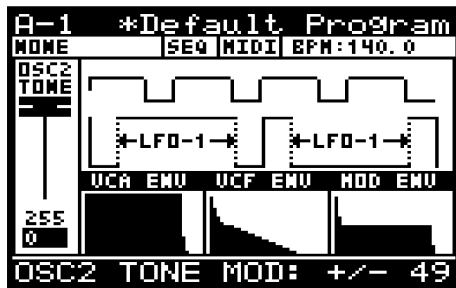

**Note:** for Uni-polar LFO sources the arrow will only point in the UP direction indicating the range of modulation. In this mode the TONE MOD fader is used to adjust the amount of modulation from 0 to +/- 49%.

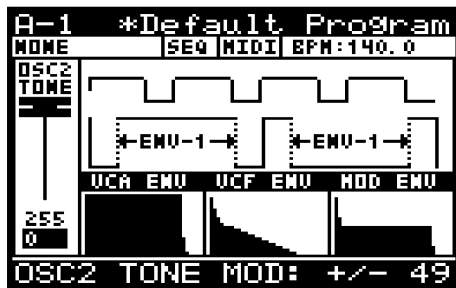

### 8.3.7 OSC 2 PITCH FADER

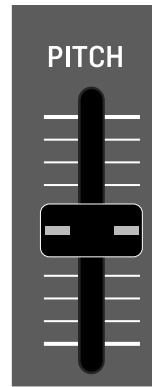

The OSC 2 PITCH fader controls the PITCH of the OSC 2 SQUARE waveform. The pitch can be tuned to match the pitch of OSC1, offset slightly to create a wider sound, or offset more to create harmonic overtones.

As you increase/decrease the PITCH fader the pitch of the oscillator will increase/decrease.

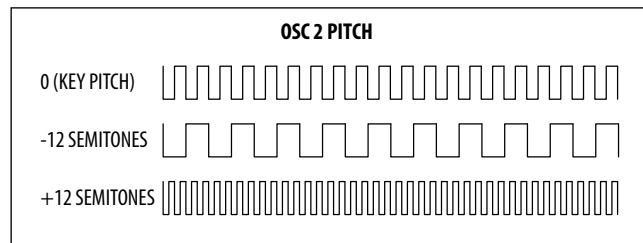

The OSC 2 PITCH range is from -12.0 semitones to +12.0 semitones. The default OSC 2 PITCH setting is 0 semitones.

The fader position, current value and stored value for the OSC 2 PITCH fader is shown on the PROG screen. There is also a visualization of the pitch setting as shown below:

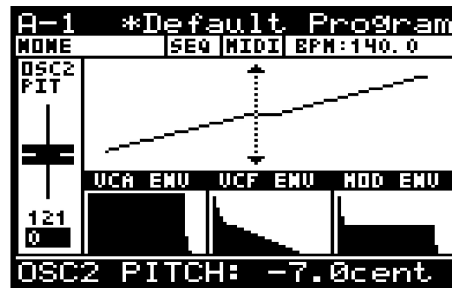

**Note:** The centre of the line shown on the visualization highlights the fine resolution that is available around the centre point. Here the units of adjustment will change from semitones to cents

### 8.3.8 OSC 2 LEVEL FADER

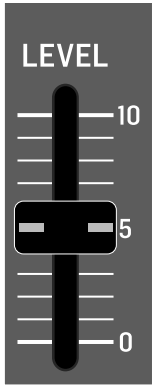

The OSC 2 LEVEL fader controls the LEVEL of the OSC 2 SQUARE waveform. The level setting can be used to adjust balance between OSC 1 and OSC 2.

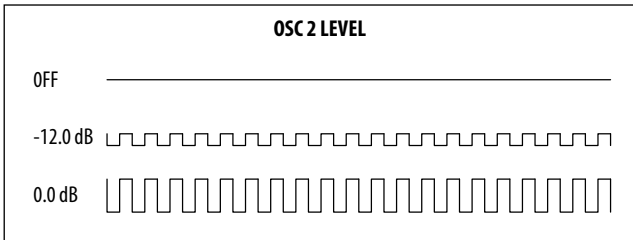

The balance between OSC 1 and OSC 2 when used together allows you to increase the sonic palette of the program. Combining oscillators can be done to create new waveforms and the harmonic structure of the program. By slightly detuning the oscillators you can create bigger, thicker sounds. Detuning in small and equal increments will not make a noticeable difference to the base pitch of the sound, but as you increase the amount of detuning it will start to become noticeable. Detuning can be done in musical intervals e.g. a fifth, or a seventh, to add harmony to a pad sound or even an entire octave to give a bass program a deeper sound.

The OSC 2 LEVEL can be set to Off, or its operational range is from -48 to 0.0 dB.

The default OSC 2 LEVEL setting is Off.

The fader position, current value and stored value for the OSC 2 LEVEL fader is shown on the PROG screen. There is also a visualization of the waveform as shown below.

**Note:** It is important to note that the visualization shows the combination of OSC 1 and OSC 2.

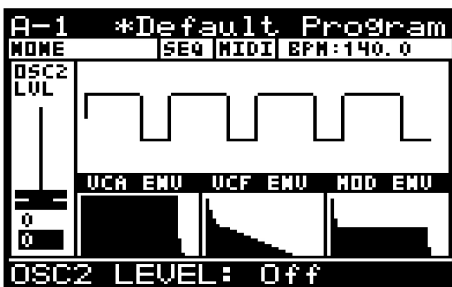

### 8.3.9 OSC SYNC SWITCH

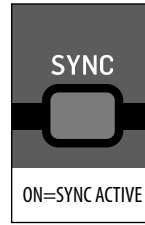

This switch controls the synchronisation of the OSCs.

The OSC 1 pitch is set by the keys that you play, and the OSC 2 pitch may be tuned to (or detuned from) this frequency. By applying hard synchronisation of OSC 2 to OSC1, every time the OSC 1 cycle starts again, the OSC 2 will be re-triggered, regardless of its position. If OSC 2 is tuned to a lower frequency than OSC 1 it will be re-triggered before it completes an entire cycle, and if it is tuned to a higher frequency it will be re-triggered during a later cycle. This ensures that the OSCs are playing at the same frequency, however the irregular cycle of OSC 2 can create complex timbres and rich harmonies.

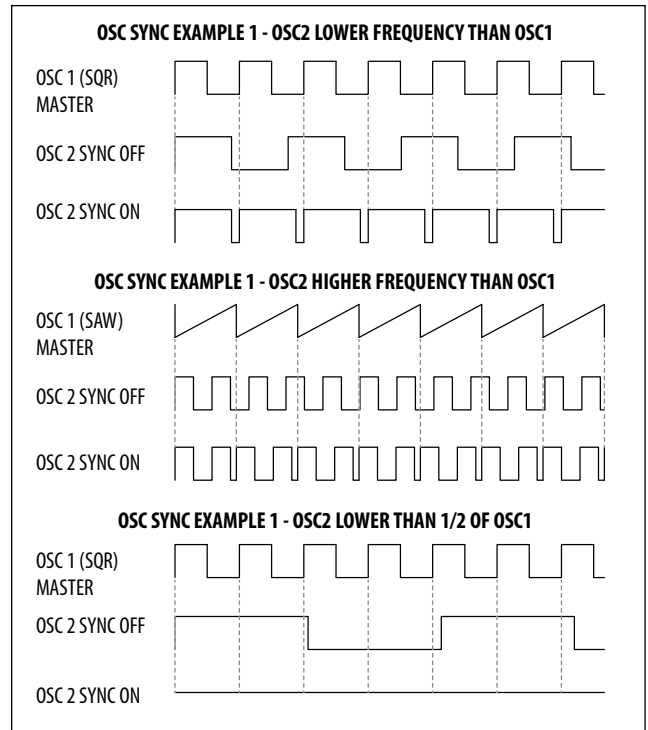

**Note:** If OSC 2 is lower than 1/2 of the frequency of OSC 1 then there will be no output from OSC 2 when SYNC is ON because the waveform will never reach its negative cycle.

The OSC SYNC option can be On/Off. The default program setting is Off.

There is also a visualization of the SYNC waveform as shown below

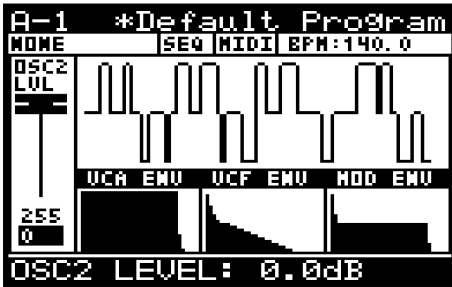

### 8.3.10 NOISE LEVEL FADER

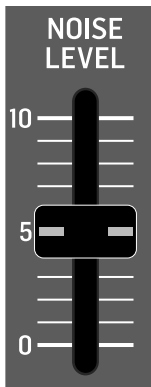

The NOISE LEVEL fader controls the LEVEL of the NOISE signal.

The noise generator is implemented using analog circuitry and creates pink noise with a low frequency roll-off designed specifically for the DeepMind 12. The noise generator is commonly used with non-pitched sounds or non-pitched components of a sound e.g. a snare drum or an atmospheric sound.

Pink noise contains equal amounts of energy in each octave. As human hearing is roughly logarithmic, this type of noise sounds as if it has an equal amount of all frequencies and produces a rushing sound similar to that of a waterfall.

The NOISE LEVEL can be set to Off, or its operational range is from -48.1 dB to 0.0 dB. The default NOISE LEVEL setting is Off.

The fader position, current value and stored value for the NOISE LEVEL fader is shown on the PROG screen. There is also a visualization of the noise signal as shown below:

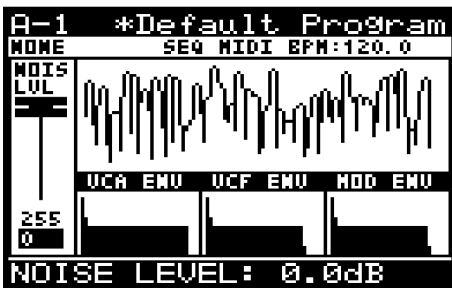

### 8.3.11 OSC EDIT SWITCH (OSC 1)

To access the OSC EDIT menu press the OSC EDIT switch.

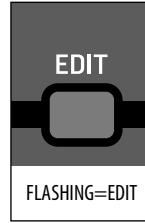

The OSC EDIT switch will then start flashing and the OSC 1 EDIT menu is then shown:

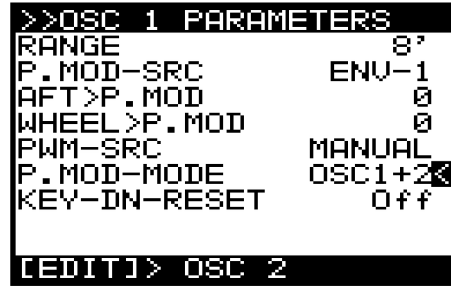

To navigate the options in the OSC 1 EDIT menu, use the UP, DOWN, switches.

Selected parameters are adjusted using the -NO/+YES switches, the rotary knob or the fader. The rotary knob has a click which allows very accurate control. The fader allows rapid adjustment across the full range:

**Note:** At this point if you wish to access the OSC 2 EDIT menu, press the EDIT switch again.

**Shortcut Note:** To change any of the OSC Modulation sources press and hold the OSC EDIT switch. While holding the switch you can use any of the following faders to set the source for the respective parameter

### 8.3.12 OSC 1 MENU

The following options are available in the OSC 1 EDIT menu:

**RANGE** - This option allows you select the base pitch of the OSC as follows:

**16'** - The lowest note on the keyboard (C) is tuned to 16.35 Hz.

**8'** - The lowest note on the keyboard (C) is tuned to 32.7 Hz.

**4'** - The lowest note on the keyboard (C) is tuned to 65.4 Hz.

The default setting for the RANGE is 8'.

**P.MOD-SRC** - This option allows you to select the source for the amount of PITCH MODULATION from the following:

- **LFO-1** - Bipolar use of the LFO 1 waveform.
- **LFO-2** - Bipolar use of the LFO 2 waveform.

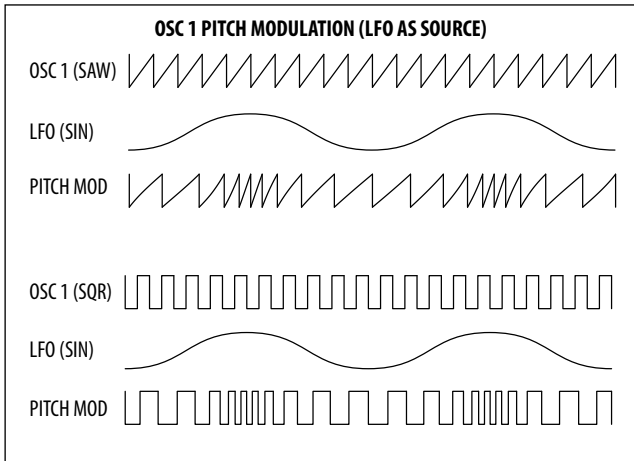

There is also a visualization of the modulation as shown below. The arrows indicate the polarity of the modulation.

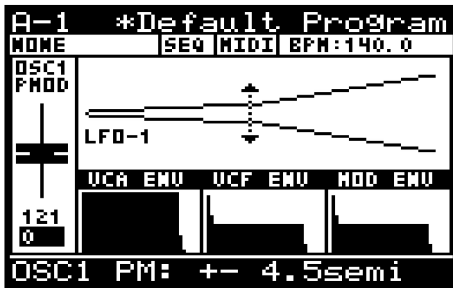

- **ENV-1** - Unipolar use of the ENV 1 envelope.
- **ENV-2** - Unipolar use of the ENV 2 envelope.
- **ENV-3** - Unipolar use of the ENV 3 envelope.

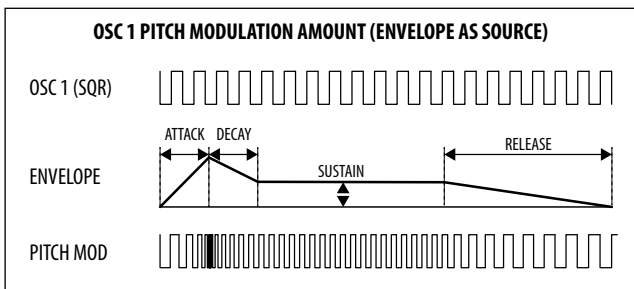

**Note:** In the visualization for ENVELOPE sources the arrow will only point in the UP direction indicating that the modulation will be positive from the base pitch.

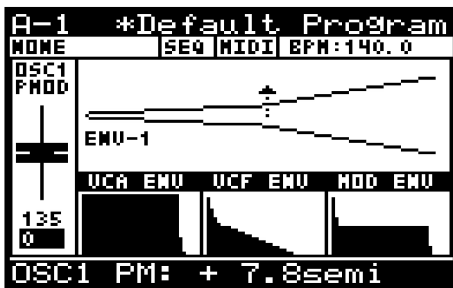

- **LFO-1(Uni)** - Unipolar use of the LFO 1 waveform.
- **LFO-2(Uni)** - Unipolar use of the LFO 1 waveform.

**Note:** In any of the Unipolar (Uni) modes the waveform is only used for positive modulation. This is useful when you want the note to play at the original frequency and modulation uses that as a reference point (Unipolar), rather than have the note modulated to positive and negative offsets (Bipolar).

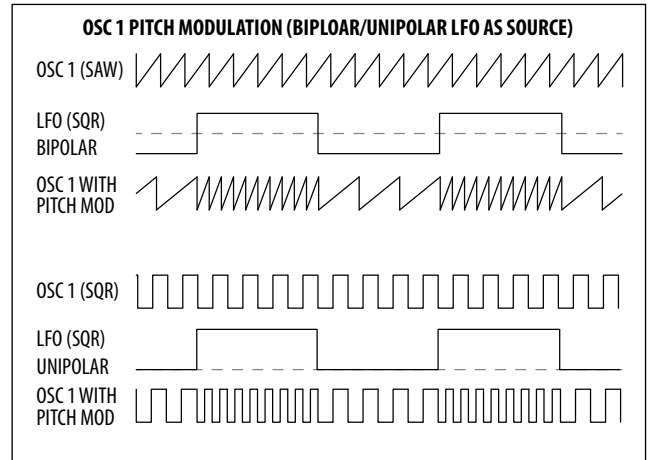

The default setting for the P.MOD-SRC is LFO-1.

**Note:** In the visualization for Uni-polar LFO sources the arrow will only point in the UP direction indicating that the modulation will be positive from the base pitch.

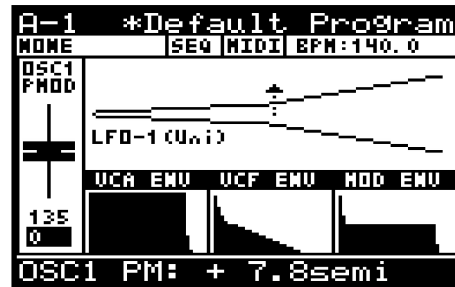

**AFT>P.MOD** - This option controls how much PITCH MODULATION is increased by AFTERTOUC pressure. This allows you to expressively control the PITCH MODULATION and its effect using key pressure

The AFT>P.MOD range is from 0-255, and the default setting is 0 (Off).

**WHEEL>P.MOD** - This option controls how much PITCH MODULATION depth is increased by the MOD WHEEL position. This allows you to expressively control the PITCH MODULATION and its effect using the MOD WHEEL.

The AFT>P.MOD range is from 0-255, and the default setting is 0 (Off).

**PWM-SRC** - This option allows you to select the source for the amount of PULSE WIDTH MODULATION from the following:

- **MANUAL** - In this mode the PWM fader is used to manually adjust the PULSE WIDTH.

- **LFO-1** - Bipolar use of the LFO 1 waveform. In this mode the PWM fader is used to adjust the amount of modulation from 0 to +/- 49%.
- **LFO-2** - Bipolar use of the LFO 2 waveform. In this mode the PWM fader is used to adjust the amount of modulation from 0 to +/- 49%.

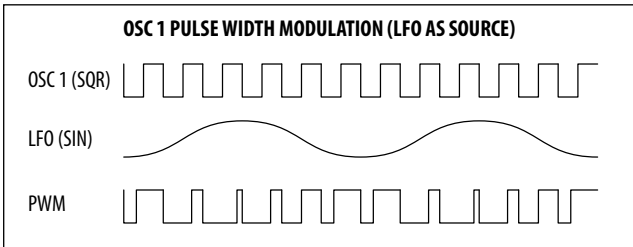

**Note:** When an LFO is used as a PWM source, the arrows indicate the range of modulation as shown below:

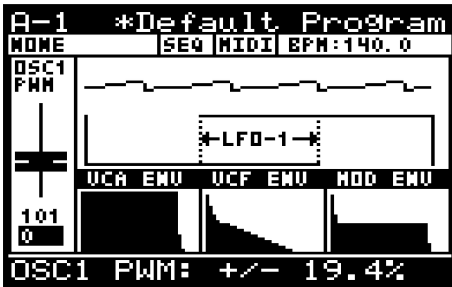

- **ENV-1** - Unipolar use of the ENV 1 envelope. In this mode the PWM fader is used to adjust the amount of modulation from 0 to +/- 49%.
- **ENV-2** - Unipolar use of the ENV 2 envelope. In this mode the PWM fader is used to adjust the amount of modulation from 0 to +/- 49%.
- **ENV-3** - Unipolar use of the ENV 3 envelope. In this mode the PWM fader is used to adjust the amount of modulation from 0 to +/- 49%.

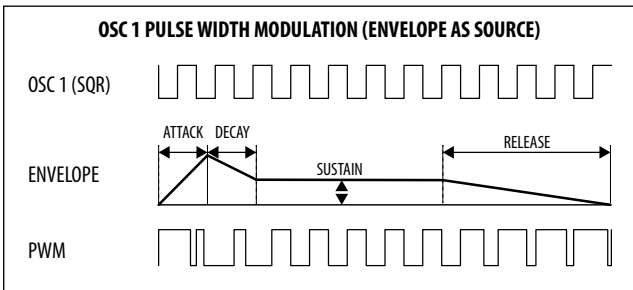

**Note:** When an ENVELOPE is used as a PWM source, the arrows indicate the range of modulation as shown below:

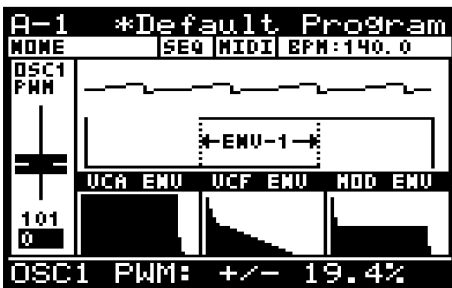

**P.MOD MODE** - This option allows you to select which oscillators are controlled by the OSC 1 PITCH MOD fader.

**Note:** It is useful to have both OSCs responding for effects like tremolo.

- **OSC1+2** - Both OSCs have PITCH MODULATION applied to them.
- **OSC1** - Only OSC 1 has PITCH MODULATION applied to it.

**KEY-DN-RESET** - This option allows you to reset the phase of oscillator waveform to start from its reset point each time a key is pressed.

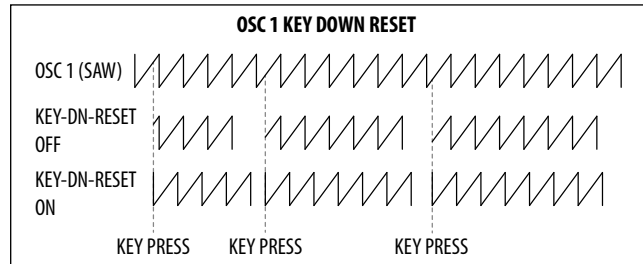

The default setting for KEY-DN-RESET is Off.

To exit the OSC EDIT menu press the PROG switch to return the main display, or to continue to the OSC 2 EDIT menu press the OSC EDIT switch again.

### 8.3.13 OSC EDIT SWITCH (OSC 2)

To access the OSC EDIT menu press the OSC EDIT switch.

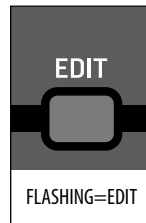

The OSC EDIT switch will then start flashing and the OSC 1 EDIT menu is then shown. Press the EDIT switch again to show the OSC 2 EDIT menu:

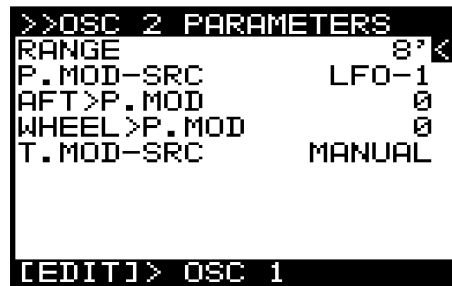

To navigate the options in the OSC 2 EDIT menu, use the UP, DOWN, switches.

Selected parameters are adjusted using the -NO/+YES switches, the rotary knob or the fader. The rotary knob has a click which allows very accurate control. The fader allows rapid adjustment across the full range.

### 8.3.14 OSC 2 MENU

The following options are available in the OSC 2 EDIT menu:

**RANGE** - This option allows you selects the base pitch of the OSC as follows:

- 16'** - The lowest note on the keyboard (C) is tuned to 16.35 Hz.
- 8'** - The lowest note on the keyboard (C) is tuned to 32.7 Hz.
- 4'** - The lowest note on the keyboard (C) is tuned to 65.4 Hz.

The default setting for the RANGE is 8'.

**P.MOD-SRC** - This option allows you to select the source for the amount of PITCH MODULATION from the following:

- **LFO-1** - Bipolar use of the LFO 1 waveform.
- **LFO-2** - Bipolar use of the LFO 2 waveform.

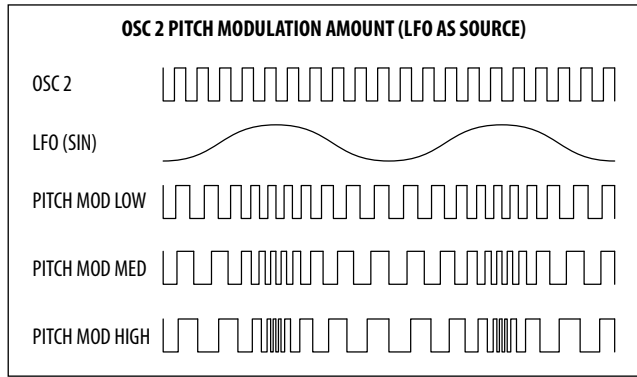

- **LFO-1(Uni)** - Unipolar use of the LFO 1 waveform.
- **LFO-2(Uni)** - Unipolar use of the LFO 1 waveform.

Note: In any of the Unipolar (Uni) modes the waveform is only used for positive modulation.

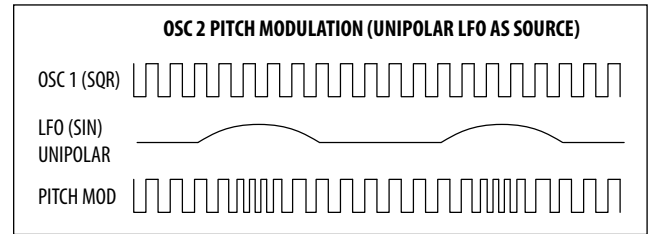

The default setting for the P.MOD-SRC is LFO-1.

**Note:** In the visualization for Uni-polar LFO sources the arrow will only point in the UP direction indicating that the modulation will be positive from the base pitch.

There is also a visualization of the modulation as shown below. The arrows indicate the polarity of the modulation..

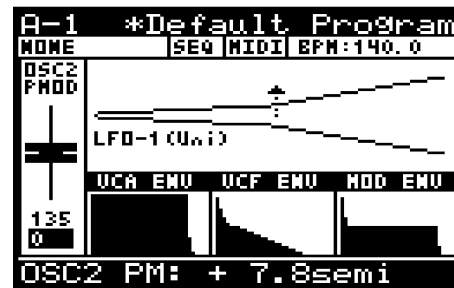
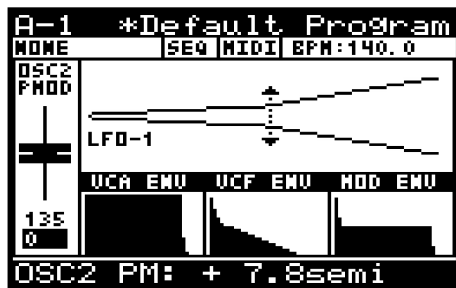

- **ENV-1** - Bipolar use of the ENV 1 envelope.
- **ENV-2** - Bipolar use of the ENV 2 envelope.
- **ENV-3** - Bipolar use of the ENV 3 envelope.

The default setting for the P.MOD-SRC is LFO-1.

**AFT>P.MOD** - This option controls how much PITCH MODULATION is increased by AFTERTOUCH pressure. This allows you to expressively control the PITCH MODULATION and its effect using key pressure.

The AFT>P.MOD range is from 0-255, and the default setting is 0 (Off).

**WHEEL>P.MOD** - This option controls how much PITCH MODULATION depth is increased by the MOD WHEEL position. This allows you to expressively control the PITCH MODULATION and its effect using the MOD WHEEL.

The MOD WHEEL>P.MOD range is from 0-255, and the default setting is 0 (Off).

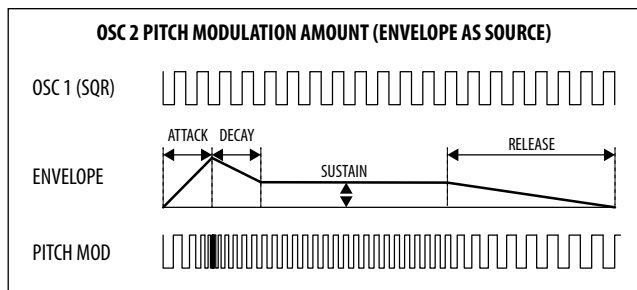

**T.MOD-SRC** - This option allows you to select the source for the amount of TONE MODULATION from the following:

- **MANUAL** - In this mode the TONE MOD fader is used to manually adjust the PWM.
- **LFO-1** - Bipolar use of the LFO 1 waveform. In this mode the TONE MOD fader is used to adjust the amount of modulation from 0 to +/- 49%.
- **LFO-2** - Bipolar use of the LFO 2 waveform. In this mode the TONE MOD fader is used to adjust the amount of modulation from 0 to +/- 49%.

**Note:** In the visualization for ENVELOPE sources the arrow will only point in the UP direction indicating that the modulation will be positive from the base pitch.

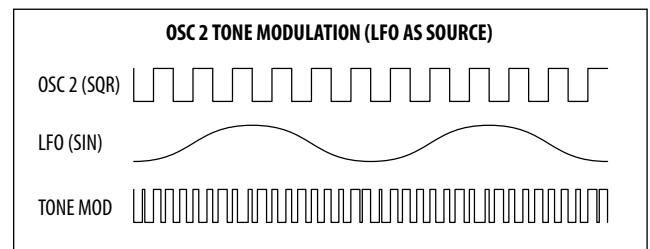
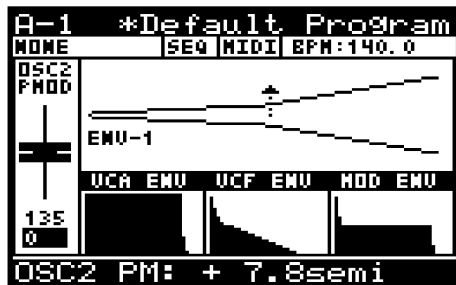

**Note:** When an LFO is used as a TONE MOD source, the arrows indicate the range of modulation as shown below:

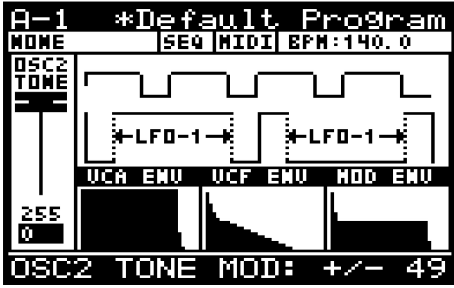

- **ENV-1** - Bipolar use of the ENV 1 envelope. In this mode the TONE MOD fader is used to adjust the amount of modulation from 0 to +/- 49%.
- **ENV-2** - Bipolar use of the ENV 2 envelope. In this mode the TONE MOD fader is used to adjust the amount of modulation from 0 to +/- 49%.
- **ENV-3** - Bipolar use of the ENV 3 envelope. In this mode the TONE MOD fader is used to adjust the amount of modulation from 0 to +/- 49%.

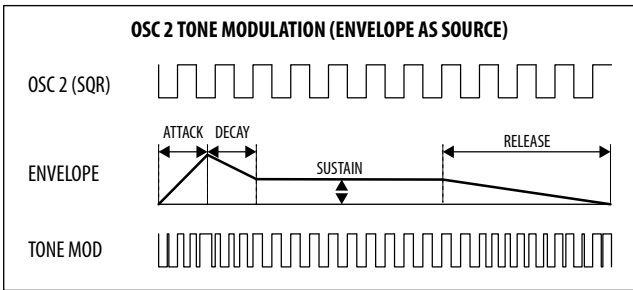

**Note:** When an ENVELOPE is used as a TONE MOD source, the arrows indicate the range of modulation as shown below.:

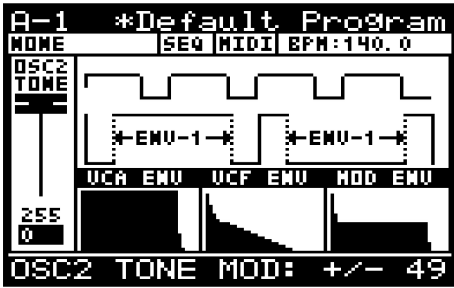

To exit the OSC EDIT menu press the PROG switch to return the main display, or because you are in the OSC 2 EDIT menu you can press the OSC EDIT switch again to return to the main display.

## 8.4 POLY

The POLY section is where you can control all settings related to the POLYPHONY of the DeepMind 12. The options allow you to be highly creative in your use of the polyphonic, unison and monophonic capabilities of the voice structure.

Having 12 voices gives you the ability to play 12 simultaneous notes, allowing the creation of large chords, or being able to play complex sequences without needing to worry about a note being cut off because there are not enough voices.

When playing voices in unison, you also have the ability to de-tune the voices.

The POLY EDIT menu also allows access to all settings related to PITCH management, including transposition, portamento, pitch bend and tuning.

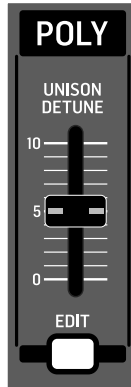

### 8.4.1 UNISON DETUNE FADER

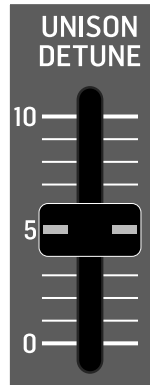

The UNISON DETUNE fader controls how much detuning is applied across voices when using any of the UNISON modes. The UNISON DETUNE can be used to create thicker and richer sounds. This is a powerful aspect of the DeepMind 12 architecture. Having 12 independent analog voices can make some extremely luxurious and sonically gigantic sounds.

When UNISON DETUNE is applied, up to +/- 50 cents of tuning is spread over the number of voices used in UNISON.

The UNISON DETUNE range is from +/-0.0cents to 50.0cents. The default UNISON DETUNE setting is 0.0cents(Off).

**Note:** When using UNISON DETUNE in combination with the OSC KEYDOWN RESET setting you will hear the affects of phase drift much more clearly as the OSCs will all start from the same point on their waveforms.

The fader position, current value and stored value for the UNISON DETUNE fader is shown on the PROG screen. There is also a visualization of the detuning amount as shown below:

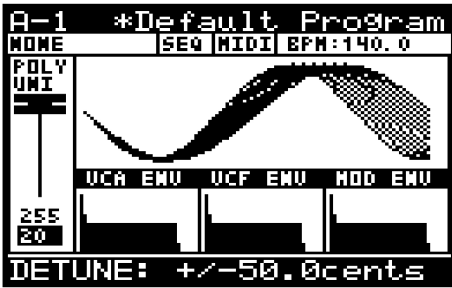

### 8.4.2 POLY EDIT SWITCH

To access the POLY EDIT menu press the POLY EDIT switch.

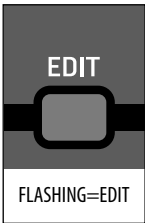

The POLY EDIT switch will then start flashing and either the VOICE PARAMETERS or PITCH PARAMETERS menu is then shown (depending on what you had last worked on, as the location is remembered).

### 8.4.3 VOICE PARAMETERS MENU

This is the VOICE PARAMETERS menu:



To navigate the options in the VOICE PARAMETERS menu, use the UP, DOWN, switches.

Selected parameters are adjusted using the -NO/+YES switches, the rotary knob or the fader. The rotary knob has a click which allows very accurate control. The fader allows rapid adjustment across the full range:

**Note:** At this point if you wish to access the PITCH PARAMETERS menu, press the EDIT switch again.

The following options are available in the VOICE PARAMETERS menu:

**POLYPHONY** - This allows you to choose how the DeepMind 12 voices are allocated from one of the following options:

- **Poly** - A single voice is allocated to each note.
- **Unison-2** - The next available two voices are allocated to each note played. Detuning is applied as shown below:

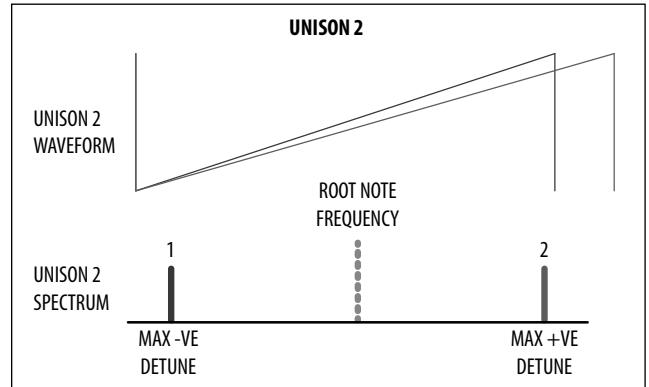

Unison-3 - The next available three voices are allocated to each note played. Detuning is applied as shown below:

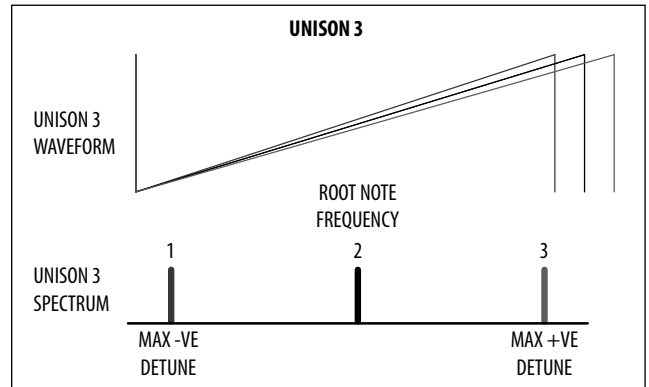

- **Unison-4** - The next available four voices are allocated to each note played. Detuning is applied as shown below:

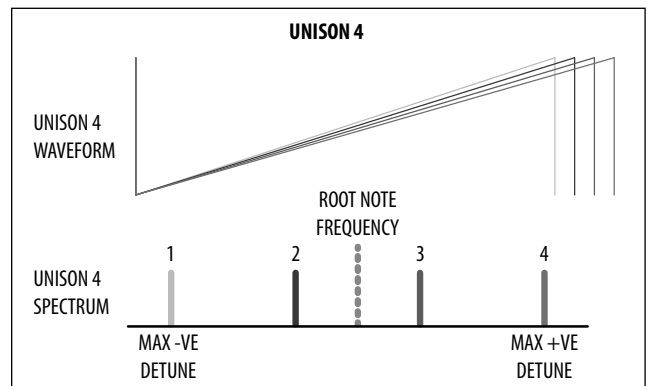



- **Unison-6** - The next available six voices are allocated to each note played. Detuning is applied as shown below:

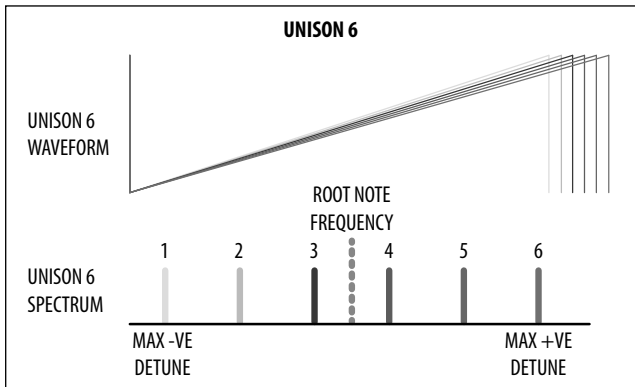

- **Unison-12** - All 12 voices are allocated to each note played

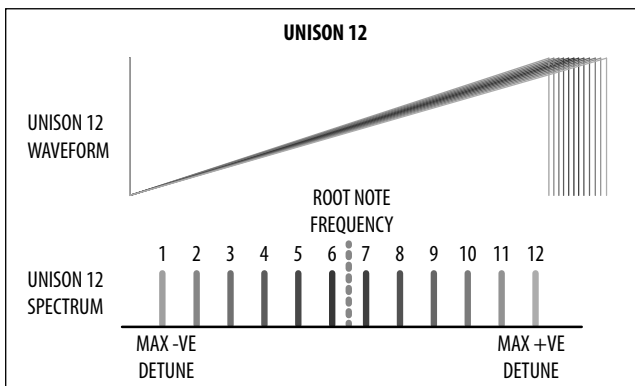

- **Mono** - The same voice is allocated to every note played.
- **Mono-2** - The same two voices are allocated to each note played. Voices are spread in the same way as Unison-2 mode.
- **Mono-3** - The same three voices are allocated to each note played. Voices are spread in the same way as Unison-3 mode.
- **Mono-4** - The same four voices are allocated to each note played. Voices are spread in the same way as Unison-4 mode.
- **Mono-6** - The same six voices are allocated to each note played. Voices are spread in the same way as Unison-6 mode.
- **Poly-6** - A single voice is allocated to each note played, but polyphony is limited to the next available six notes.
- **Poly-8** - A single voice is allocated to each note played, but polyphony is limited to the next available eight notes.

**Note:** When an even number of voices are used (Unison 2/4/6/12, Mono 2/4/6) the voices are spread across the spectrum evenly which means the root note is not actually played. However if an odd number of voices are used, when the voices are spread across the spectrum one voice will be playing the root note.

**UNISON DETUNE** - This option is the same as the UNISON DETUNE fader on the surface. Any changes on the surface will be reflected here.

The UNISON DETUNE range is from +/-0.0cents to 50.0cents (0 to 255). The default UNISON DETUNE setting is 0.0cents(Off).

**PRIORITY** - When in monophonic mode, or when more notes are played than there are voices available (due to polyphonic/unison settings), this mode controls which notes are prioritized.

- **Lowest** - In lowest note priority, when a newly requested note is lower in pitch than the notes currently being played then it will be given priority and will steal the voice that is playing the highest note.
- **Highest** - In highest note priority, when a newly requested note is higher in pitch than the notes currently being played then it will be given priority and will steal the voice that is playing the lowest note.
- **Last** - In this mode the notes are prioritized based on the order in which they are played. When a newly requested note is triggered while all voices are playing, it steals the voice used by the note played least recently.

The default PRIORITY setting is Last.

**ENV-TRIGGER** - The envelopes can be triggered in different ways. This allows you to choose a mode from the following options:

- **Mono** - In this triggering mode the voice will start its attack stage from the current envelope level. I.e. its last level from the previous release.
- **Retrigger** - In this triggering mode the envelope will be reset to zero and then start its attack stage.
- **Legato** - In this triggering mode the envelope does not re-trigger when a new note is played. The only time the envelope will start the attack stage again is once the note is released.
- **One-shot** - In this triggering mode the envelope will be reset to zero and then start its attack stage. Once the decay phase is complete the envelope will jump immediately to its release stage (i.e. there is no sustain phase)

The default triggering mode is Mono.

**OSC-DRIFT** - This option allows you to recreate the tuning drift that vintage analog synthesizers have.

As you increase the OSC-DRIFT value, the pitch of the oscillators will be slowly modulated at random.

OSC-DRIFT is applied to both OSC 1 and OSC 2.

The OSC-DRIFT range is from 0 to 255. The default OSC-DRIFT setting is 0.

**PARAM-DRIFT** - This option allows you to recreate the drift that many parameters in a vintage analog synthesizers have.

As you increase the PARAM-DRIFT value, the drift distances will increase.

**Note:** The parameters which DRIFT is applied to are OSC1 PITCH MOD, OSC1 PWM, OSC2 PITCH MOD, OSC2 TONE MOD, VCF FREQ, VCF RES, VCF ENV DEPTH, VCF LFO DEPTH, VCA ENV DEPTH and MOD ENV DEPTH.

The PARAM-DRIFT range is from 0 to 255. The default PARAM-DRIFT setting is 0.

**DRIFT-RATE** - This controls the RATE at which the OSC-DRIFT and PARAM-DRIFT operate at. It is important to note that each voice has independent random DRIFT generators for the OSC-DRIFT and the PARAM-DRIFT to more closely replicate the characteristics of a vintage synthesizer.

The rate is controlled by a random timer which generates a ramp between a multiplier of 1x and a multiplier of 2x the rate set by the DRIFT-RATE parameter.

The OSC-DRIFT range is from 0(25 ms-50 ms) to 255(2.5 s-5.0 s). The default OSC-DRIFT setting is 0.

To summarize, if at 0, each "drift" will be a random time between 25 and 50 ms and then the parameter drifts to another random value. At 255, each "drift" will be a random time between 2.5 s and 5.0 s and then the parameter drifts to another random value.

To exit the VOICE PARAMETERS menu press the PROG switch to return the main display.

### 8.4.4 PITCH PARAMETERS MENU

To access the PITCH PARAMETERS menu press the POLY EDIT switch.

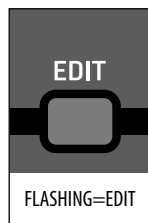

The POLY EDIT switch will then start flashing and the VOICE PARAMETERS menu is then shown. Press the EDIT switch again to show the PITCH PARAMETERS menu:



**Note:** The page location memory function can be turned off using the REMEMBER PAGES function in the GLOBAL SETTINGS menu.

To navigate the options in the PITCH PARAMETERS menu, use the UP, DOWN, switches.

Selected parameters are adjusted using the -NO/+YES switches, the rotary knob or the fader. The rotary knob has a click which allows very accurate control. The fader allows rapid adjustment across the full range:

The following options are available in the PITCH PARAMETERS menu:

**TRANSCOPE** - This option allows you to TRANSCOPE notes played on the keyboard. The notes played can be transposed in steps of single semitones.

The TRANSCOPE range is from -48 to +48. The default TRANSCOPE setting is 0.

So a transpose of -7 would mean that all played keys would be transposed down by seven semitones.

**PORTA-TIME** - This option is the same as the PORTAMENTO knob on the surface. Any changes on the surface will be reflected here.

The PORTAMENTO function makes the pitch of a note glide up or down from the previously played note. The PORTAMENTO knob controls the time taken to transition from the previous note to the currently played note.

The PORTAMENTO range is from 0(0.00s - instant change of note) to 255(10.00s of glide). The default PORTAMENTO setting is 0(0.00s/Off).

**PORTA-MODE** - This option allows you to configure the PORTAMENTO function to operate in different ways depending on your requirements. The options are as follows:

- **Normal** - In this mode the slide time between played notes is a fixed time, regardless of overlapping notes or pitch distance. The sliding between notes is linear.
- **Fingered** - In this mode the slide time between played notes is a fixed time, regardless of pitch distance. Sliding is only applied when notes overlap. The sliding between notes is linear.
- **Fix-Rate** - In this mode the slide time between played notes is a fixed rate, regardless of overlapping notes. The pitch distance from note to note will affect the time it takes to slide between notes. The sliding between notes is linear.
- **Fix-Fing** - In this mode the slide time between played notes is a fixed rate. The pitch distance from note to note will affect the time it takes to slide between notes. Sliding is only applied when notes overlap. The sliding between notes is linear.
- **Exp** - In this mode the slide time between played notes is a fixed rate. The pitch distance from note to note will affect the time it takes to slide between notes. Sliding is only applied when notes overlap. The sliding between notes is exponential.
- **Exp-Fing** - In this mode the slide time between played notes is a fixed rate. The pitch distance from note to note will affect the time it takes to slide between notes. Sliding is only applied when notes overlap. The sliding between notes is exponential.
- **Fixed+2** - In this mode the note always starts at a pitch two semitones above the played note regardless of overlapping notes or pitch distance. The sliding between notes is exponential.
- **Fixed-2** - In this mode the note always starts at a pitch two semitones below the played note regardless of overlapping notes or pitch distance. The sliding between notes is exponential.
- **Fixed+5** - In this mode the note always starts at a pitch five semitones above the played note regardless of overlapping notes or pitch distance. The sliding between notes is exponential.
- **Fixed-5** - In this mode the note always starts at a pitch five semitones below the played note regardless of overlapping notes or pitch distance. The sliding between notes is exponential.
- **Fixed+12** - In this mode the note always starts at a pitch twelve semitones (one octave) above the played note regardless of overlapping notes or pitch distance. The sliding between notes is exponential.
- **Fixed-12** - In this mode the note always starts at a pitch twelve semitones (one octave) below the played note regardless of overlapping notes or pitch distance. The sliding between notes is exponential.
- **Fixed+24** - In this mode the note always starts at a pitch twenty-four semitones (two octaves) above the played note regardless of overlapping notes or pitch distance. The sliding between notes is exponential.
- **Fixed-24** - In this mode the note always starts at a pitch twenty-four semitones (two octaves) below the played note regardless of overlapping notes or pitch distance. The sliding between notes is exponential.

**PORTA-OSC-BAL** - This option allows you to balance the application of PORTA-TIME (i.e. the slide time between played notes) between OSC 1 and OSC 2.

When a positive setting is chosen, the OSC 1 PORTA-TIME will decrease. At its maximum value (127) the OSC 1 PORTA-TIME will be zero and the pitch change will happen immediately (no sliding).

When a negative setting is chosen, the OSC 2 PORTA-TIME will decrease. At its minimum value (-127) the OSC 2 PORTA-TIME will be zero and the pitch change will happen immediately (no sliding).

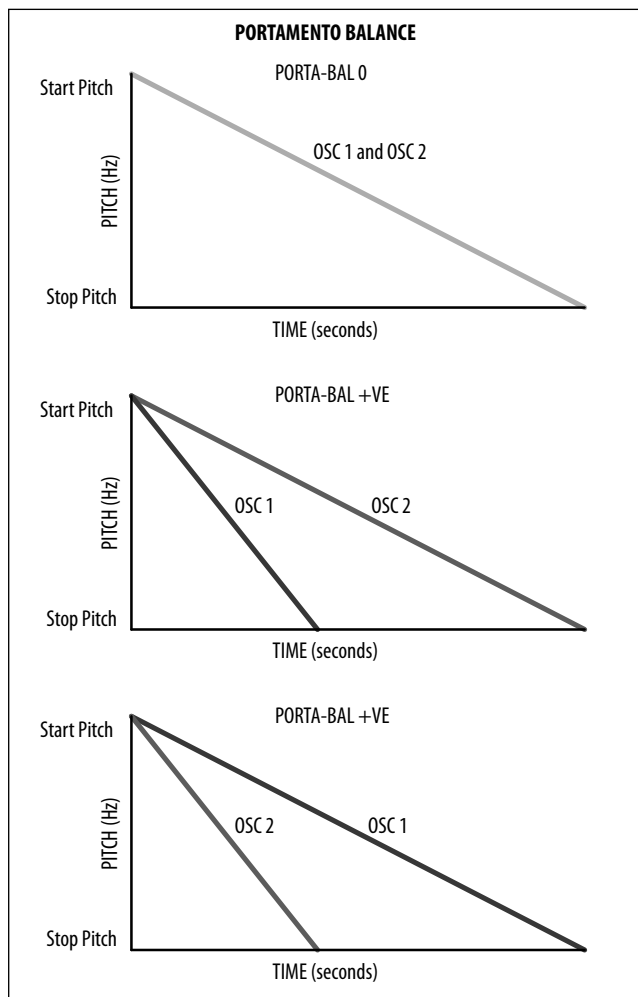

The PORTA-OSC-BAL parameter ranges from -128 to 127. The default setting is 0.

**P.BEND RANGE+** - This option allows you to set the upper limit of the PITCH WHEEL.

The P.BEND RANGE+ parameter can be varied from 0(0 notes) to 24(24 notes). The default P.BEND RANGE+ setting is 2(2 notes).

**P.BEND RANGE-** - This option allows you to set the lower limit of the PITCH WHEEL.

The P.BEND RANGE- parameter can be varied from 0(0 notes) to 24(24 notes). The default P.BEND RANGE- setting is 2(2 notes).

**GLOBAL-TUNE** - This option allows you to adjust the GLOBAL TUNING for the synthesizer. The range is -128 to 127.

To exit the PITCH PARAMETERS menu press the PROG switch to return the main display, or because you are in the PITCH PARAMETERS menu you can press the POLY EDIT switch again to return to the main display.

## 8.5 VCF

The VOLTAGE CONTROLLED FILTER (VCF) is an advanced filter designed specifically for the DeepMind 12. The VCF filter changes the tone color created by the OSCs and NOISE generator by cutting off, or emphasizing frequencies/harmonics. The VCF stage allows the low frequencies to pass and cuts off higher frequencies. This approach is used by many classic subtractive synthesizers.

The VCF is a fully analog filter, with the ability to be switched from a 2-pole/12 dB per octave filter to 4-pole/24 dB per octave filter. The dB per octave refers to the angle of the filter's slope/response curve.

The VCF also has adjustable resonance which creates a narrow peak around the filter cut-off frequency. The DeepMind 12 filter is capable of being driven into self oscillation when the resonance setting is high. Unlike many other synthesizers, the synthesizer is capable of accurate pitch tracking even when the filter resonance is pushed to (and past) the point where the filter starts to self-oscillate. The self-oscillation is tuned so that you can play it as a fully polyphonic 3rd oscillator across the entire range of playable notes.

The VCF can be modulated dynamically by the VCF Envelope, LFO or Keyboard Tracking. The VCF Frequency is also available in the Mod Matrix as a destination where it can be modulated from any of the Mod Matrix sources.

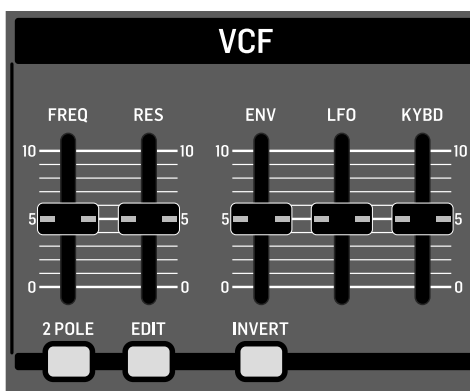

### 8.5.1 VCF FREQ FADER

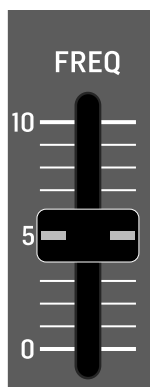

The VCF FREQ fader controls the cut-off frequency of the VCF. The VCF will begin cutting frequencies below the cut-off frequency and continue to cut them at a rate depending on the number of poles used.

You can use the filter to sculpt the sonic characteristics of the OSCs and noise generator, or you can dynamically adjust the fader to create sweeps of the filter which will create distinctive movement.

Modulating the cut-off frequency with sources such as an envelope generator, with fast attack settings can help emulate the attack transients of natural instruments, or be used to creative effect.

The diagram below shows the results from high, medium and low settings of the cut-off frequency when applied to the SAWTOOTH and SQUARE waveforms.

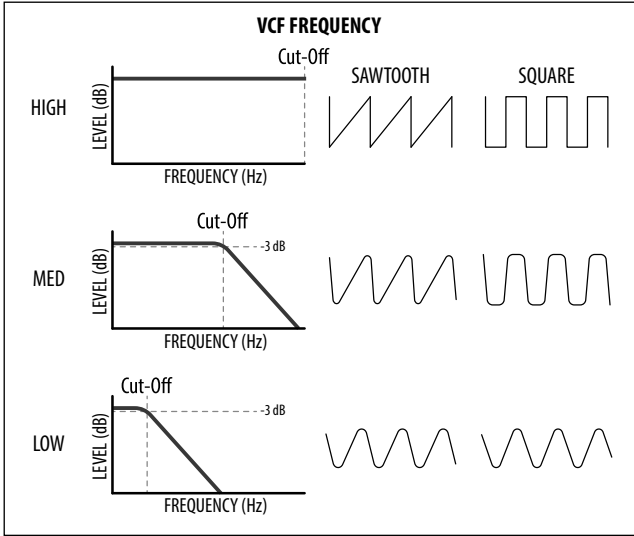

The VCF FREQ range is from 50.0 Hz to 20000.0 Hz. The default VCF FREQUENCY setting is 20000.0 Hz (fully open).

The fader position, current value and stored value for the VCF FREQ fader is shown on the PROG screen. There is also a visualization of the filter curve as shown below.

**Note:** The slope of the filter will update depending on the use of a 2-pole or 4-pole configuration.

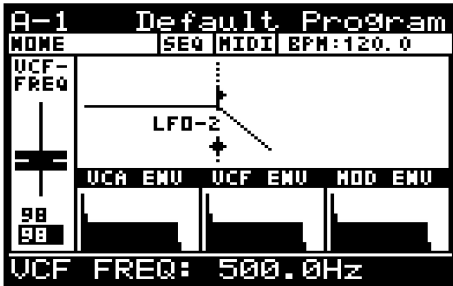

**8.5.2 VCF RES FADER**

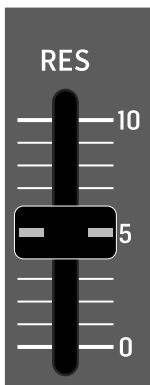

The VCF RES fader controls the resonance of the filter. When resonance is increased the frequencies/harmonics/partial around the cut-off frequency are emphasized. The resonance along with the filter slope help define the character of the filter.

The DeepMind 12 filter is capable of being driven into self oscillation. Unlike many other synthesizers, the synthesizer can guarantee an accurate pitch even when the filter resonance is pushed to (and past) the point where the filter starts to self-oscillate. When using this self-oscillating feature of the VCF as a sound source, the VCF calibration ensures the correct response when playing the entire scale of the keyboard. For more information please consult the section on calibration later in this document.

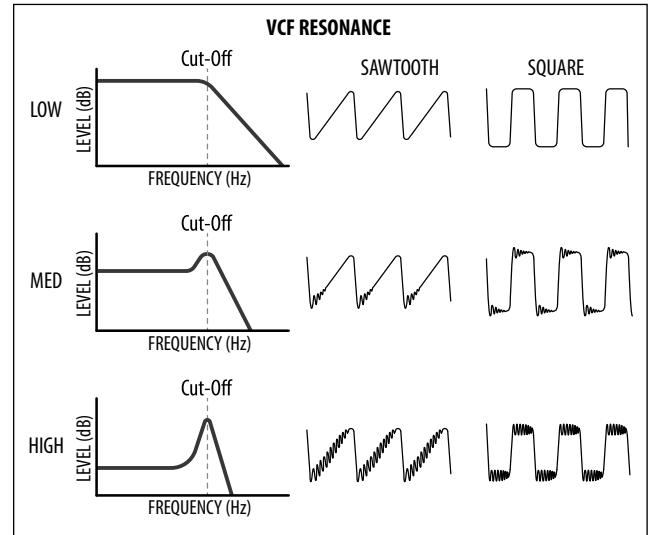

The VCF RES range is from 0.0% to 100.0%. The default VCF RES setting is 0.0%.

The fader position, current value and stored value for the VCF RES fader is shown on the PROG screen. There is also a visualization of the resonance as shown below

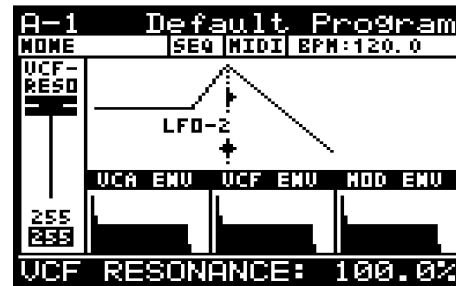

**8.5.3 2-POLE SWITCH**

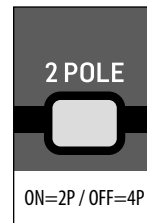

This switch controls the configuration of poles used in the VCF.

The number of poles used in the filter determines the angle of the filters slope/ response curve.

The VCF uses 4-poles, but can be switched into 2-pole operation. If configured for 4-pole operation the low-pass filter rolls off signals above the cut-off frequency at a rate of 24 dB/octave. When configured for 2-pole operation the low-pass filter rolls off signals above the cut-off frequency at a rate of 12 dB/octave.

This can be useful to control the sonic character of the filter as the 2-pole mode will allow more of the signal above the cut-off frequency to pass and sound brighter / more natural. The 4-pole mode allows less of the signal above the cut-off frequency to pass and sounds deeper/ more unusual.

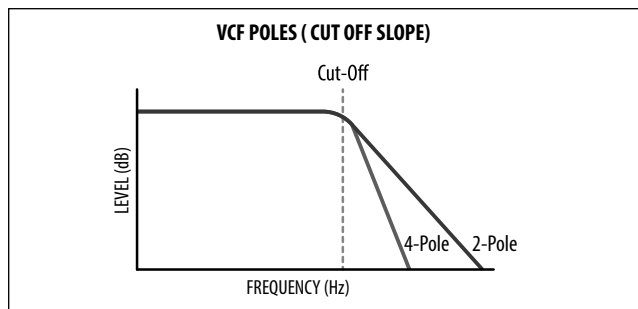

The 2-POLE configuration can be On(2-Pole) or Off(4-Pole). The default program setting is Off(4-Pole).

#### 8.5.4 VCF EDIT SWITCH

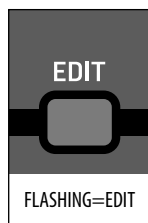

To access the VCF menu press the VCF EDIT switch.

The VCF EDIT switch will then start flashing and the VCF PARAMETERS menu is then shown:

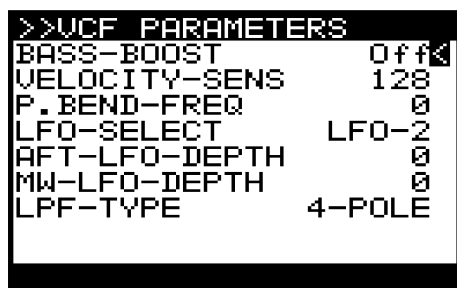

To navigate the options in the VCF PARAMETERS menu, use the UP, DOWN, switches.

Selected parameters are adjusted using the -NO/+YES switches, the rotary knob or the fader. The rotary knob has a click which allows very accurate control. The fader allows rapid adjustment across the full range:

The following options are available in the VCF PARAMETERS menu:

**BASS-BOOST** - This option engages an analog bass boost circuit. This setting follows the BOOST switch status.

**VELOCITY-SENS** - This option controls how much the velocity at which you strike the keys will affect how much VCF envelope modulation is applied. I.e. the harder you strike the keys, the more the filter will open and the brighter the sound will become (unless the operation is inverted using the INVERT switch).

The VELOCITY-SENS range is from 0 to 255. The default VELOCITY-SENS setting is 128.

**P.BEND-FREQ** - This option controls how much the PITCH BEND WHEEL position will affect the cut-off frequency. I.e. the further you move the wheel forward from its central position, the more the filter will open and the brighter the sound will become, the further you move the wheel backward from its central position, the more the filter will close and the darker the sound will become.

The P.BEND-FREQ range is from 0 to 255. The default P.BEND-FREQ setting is 128.

**LFO-SELECT** - This option allows you to select which LFO is assigned to the VCF LFO MODULATION FADER.

You can select either LFO 1 or LFO 2. The default setting is LFO 2, which allows you to use LFO 1 for voice modulation and keep the functionality separated. You can of course use the same LFO to modulate the OSC and VCF if you desire.

**AFT-LFO-DEPTH** - This option controls how much the AFTERTOUC pressure will increase the LFO MODULATION DEPTH. This allows you to add LFO modulation of the filter frequency expressively while you play.

The AFT-LFO-DEPTH range is from 0 to 255. The default AFT-LFO-DEPTH setting is 0.

**MW-LFO-DEPTH** - This option controls how much the MOD WHEEL position will affect the LFO MODULATION DEPTH. This allows you to add LFO modulation of the filter frequency expressively while you play.

The MW-LFO-DEPTH range is from 0 to 255. The default MW-LFO-DEPTH setting is 0.

**LPF-TYPE** - This option is the same as the 2-POLE switch on the surface. Any changes on the surface will be reflected here.

The LPF-TYPE configuration can be 2-POLE or 4-POLE. The default program setting is 4-POLE.

#### 8.5.5 VCF ENV FADER

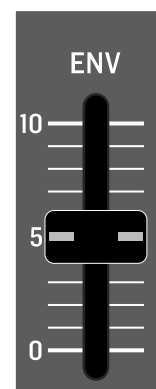

The VCF ENV fader controls the amount of VCF ENVELOPE modulation that will be applied to the cut-off frequency value.

When the cut-off frequency is modulated by the VCF ENVELOPE each note will be affected by the ADSR (and Curves) stages for the VCF ENVELOPE. You can use this to apply subtle or aggressive modulation to the harmonic characteristics of each note played for the duration they are playing.

When modulating the cut-off frequency using the VCF ENVELOPE, it is advised to set the fader to a lower level when using normal polarity, and set it to a higher level when using the INVERT function of the VCF ENVELOPE MODULATION parameter.

When no ENV MODULATION is applied the filter cut-off frequency will stay fixed (unless other sources of modulation are applied).

The cut-off frequency setting can limit the modulation from the VCA ENVELOPE. If the VCF FREQ fader is already at its maximum setting, and the filter is already wide open then no positive modulation can take the cut-off frequency higher.

## EN

This is also true for negative values when the VCF ENVELOPE is inverted.

The VCF ENV range is from 0.0% to 100.0%. The default VCF ENV setting is 0.0%(Off).

The fader position, current value and stored value for the VCF ENV fader is shown on the PROG screen. There is also a visualization of the envelope amount (the arrow pointing to the right) as shown below:

**Note:** When you invert the polarity of the envelope, the arrow indicating the envelope modulation will be reversed and point to the left to indicate negative modulation.

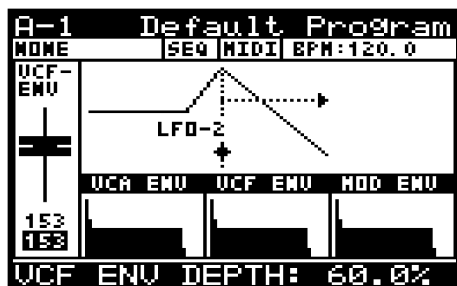

### 8.5.6 INVERT SWITCH

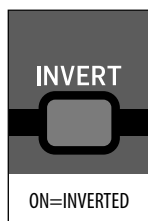

This switch controls the polarity of the VCF ENVELOPE modulation. When the switch is on, the polarity of the envelope will be inverted.

It is advised to set the fader to a lower level when using normal polarity, and set it to a higher level when using the INVERT function of the VCF ENVELOPE MODULATION parameter.

The INVERT switch can be set to On or Off. The default program setting is On.

### 8.5.7 VCF LFO FADER

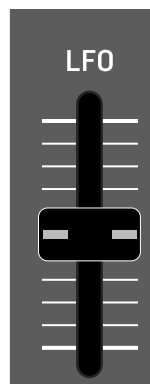

The VCF LFO fader controls the amount of VCF LFO modulation that will be applied to the cut-off frequency value. You can select which LFO will be used as the modulation source in the VCF PARAMETERS menu.

When the cut-off frequency is modulated by the VCF LFO each note will be affected by the shape and speed of the LFO. You can use this aggressively to create a wah pedal type effect, or used subtly to add movement and variation to the program.

When no LFO MODULATION is applied the filter cut-off frequency will stay fixed (unless other sources of modulation are applied).

The cut-off frequency setting can limit the modulation from the LFO. If the VCF FREQ fader is already at its maximum setting, and the filter is already wide open then no positive modulation can take the cut-off frequency higher.

The VCF LFO range is from 0.0% to 100.0%. The default VCF LFO setting is 0.0%(Off).

The fader position, current value and stored value for the VCF LFO fader is shown on the PROG screen. There is also a visualization of the LFO amount (the arrows pointing left and right below the LFO-1 text) as shown below:

**Note:** The distance between the arrows represents the amount of LFO modulation which is being applied to the filter cut-off frequency.

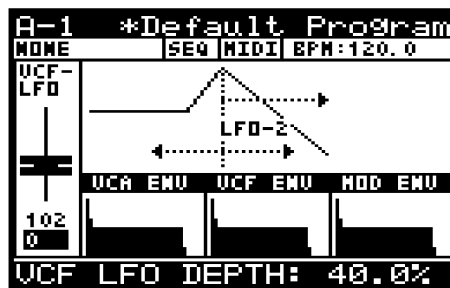

**Shortcut Note:** To change the VCF LFO source press and hold the VCF EDIT switch. While holding the switch you can use the VCF LFO fader to select the source LFO. The following message will be shown to give you guidance while holding the LFO 1 EDIT switch.

### 8.5.8 VCF KYBD FADER

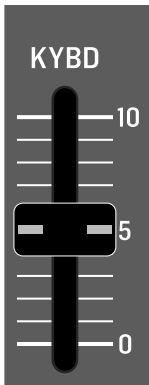

The VCF KYBD fader controls the keyboard tracking of the VCF. The keyboard tracking can be used to compensate the cut-off frequency of the filter depending on the notes being played.

It can prevent inconsistencies in the harmonic content caused by pitch changes.

When the VCF KYBD fader is raised, the higher the note (above the middle C) played on the keyboard, the more the filter opens. At the same time the lower the note (below the middle C) played on the keyboard, the more the filter closes.

This modulation can be used to emulate the response of a natural instrument, or used to creative effect.

The VCF KYBD range is from 0.0% to 100.0%. The default VCF KYBD setting is 0.0%(Off).

The fader position, current value and stored value for the VCF KYBD fader is shown on the PROG screen. There is also a visualization of the modulation amount as shown below:

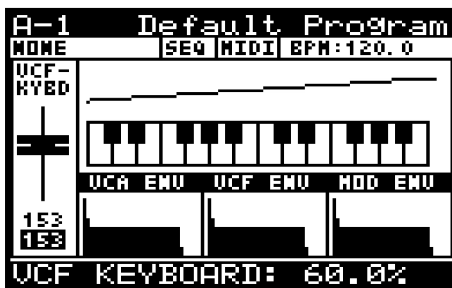

### 8.6 VCA

The VOLTAGE CONTROLLED AMPLIFIER (VCA) is split into two stages. The first is a per voice stereo VCA which can be modulated by the VCA ENVELOPE, the PAN-SPREAD setting, the VELOCITY SENSITIVITY of the keyboard and the Pan Destination in the Mod Matrix.

The second stage is a common VCA used to correct, or compensate the level so that it is consistent between programs.

Both stages use a voltage to control the amount of signal passed through to the next stage. The higher the control voltage, the more of the signal will be passed.

The per voice VCA Level is also available in the Mod Matrix as a destination where it can be modulated from any of the Mod Matrix sources.

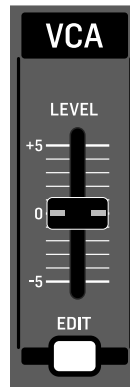

#### 8.6.1 LEVEL

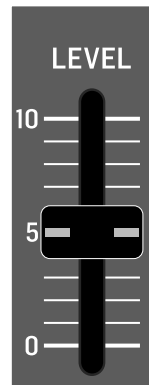

The VCA LEVEL fader controls the second stage of the VCA, i.e. how much amplification or attenuation is applied to the summed voice signals.

The VCA LEVEL range is from -12.0 dB to 6.0 dB. The default VCA LEVEL setting is 0.0 dB(Off).

The fader position, current value and stored value for the VCA LEVEL fader is shown on the PROG screen. There is also a visualization of the position as shown below:

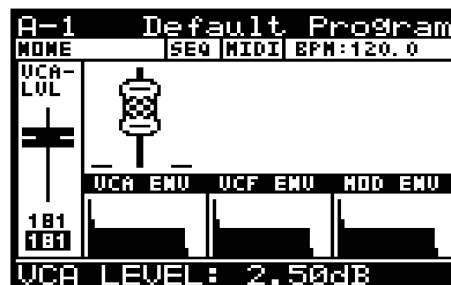

### 8.6.2 VCA EDIT MENU

To access the VCA PARAMETERS menu press the VCA EDIT switch.

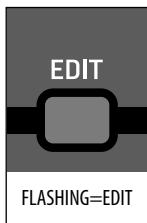

The VCA EDIT switch will then start flashing and the VCA PARAMETERS menu is then shown.



To navigate the options in the VCA PARAMETERS menu, use the UP, DOWN, switches.

Selected parameters are adjusted using the -NO/+YES switches, the rotary knob or the fader. The rotary knob has a click which allows very accurate control. The fader allows rapid adjustment across the full range:

The following options are available in the VCA PARAMETERS menu:

**ENVELOPE-DEPTH** - This option allows you to control how much the VCA ENVELOPE will be used to modulate the per voice VCA.

This is the primary method to sculpt the shape of a sound. For more information please consult the section on the VCA ENVELOPE

The ENVELOPE-DEPTH range is from 0 to 255. The default ENVELOPE-DEPTH setting is 255.

**VELOCITY-SENS** - This option allows you to control how much the velocity at which you strike the keys will affect the per voice VCA. I.e. the harder you strike the keys, the louder the sound and the softer you strike the keys the quieter the sound will be.

The VELOCITY-SENS range is from 0 to 255. The default VELOCITY-SENS setting is 128.

**PAN-SPREAD** - This option allows you to control how much the individual voices will be spread across the stereo image.

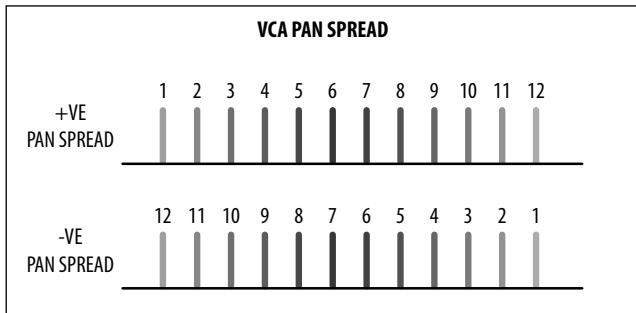

The PAN-SPREAD range is from 0 to 255. The default PAN-SPREAD setting is 0.

### 8.7 HPF

The HIGH PASS FILTER (HPF) is applied to the output of the VCA. Because the VCA has summed all the voices the HPF will affect all voice simultaneously by design.

#### 8.7.1 HPF FREQ FADER

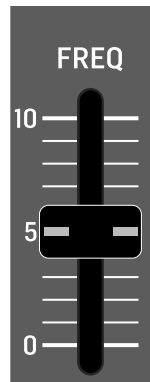

The HPF FREQ fader controls the cut-off frequency of the HPF. The HPF will begin cutting frequencies above the cut-off frequency at continue to cut them at a rate of -6 dB per octave.

The HPF filter can be useful to remove subsonic frequencies from your sound if required. You can also use the filter to sculpt the sonic characteristics of the program, or you can dynamically adjust the fader to create sweeps of the filter which will create distinctive movement.

The HPF Frequency is available in the Mod Matrix as a destination where it can be modulated from any of the Mod Matrix sources.

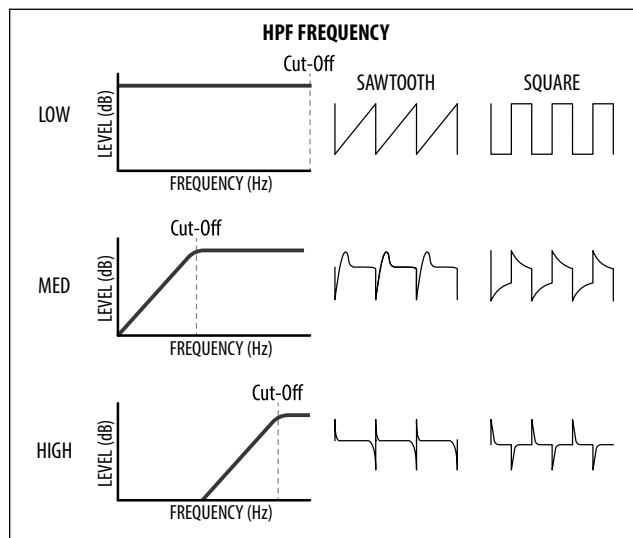

The HPF FREQ range is from 20.0 Hz to 2000.0 Hz. The default HPF FREQ setting is 20.0 Hz (fully open).



The fader position, current value and stored value for the HPF FREQ fader is shown on the PROG screen. There is also a visualization of the filter curve as shown below.

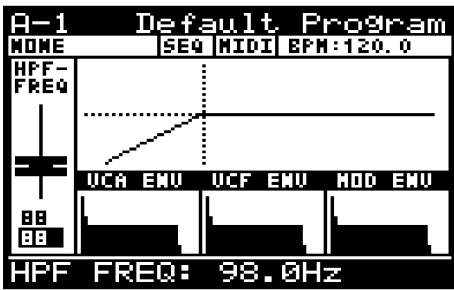

### 8.7.2 BOOST SWITCH

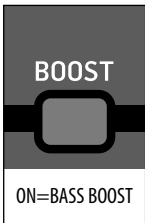

This switch controls the BOOST stage of the DeepMind 12.

The boost function enables an analog circuit which is designed to boost low frequencies at 100 Hz using a shelving equalization and DC blocking functionality..

The BOOST function can be used to give programs an enhanced low frequency response resulting in more depth and body

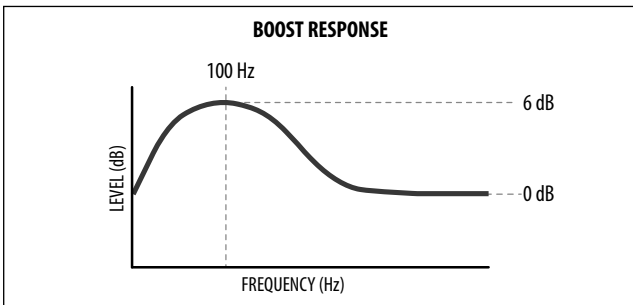

The BOOST function can be On/Off. The default program setting is Off.

There is also a visualization of the BOOST filter curve on the PROG screen as shown below.

**Note:** You will only see the BOOST visualization if the HPF fader was the last fader that was moved..

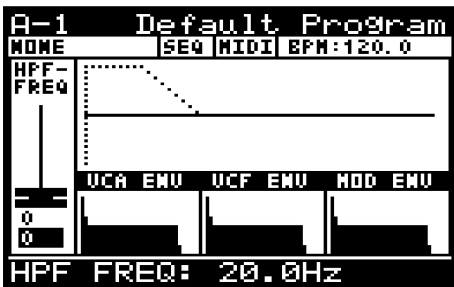

## 8.8 ENVELOPES

The DeepMind 12 has three envelope generators. Each of these generates a control signal with 4 stages (Attack, Decay, Sustain and Release).

The VCA envelope is used to adjust the level of the note being played over time.

The VCF envelope is used to adjust the cut-off frequency of the filter for each note played over time.

The MOD envelope can be used to modulate any of the MOD MATRIX destinations for each note being played over time.

The envelopes are normally triggered by the playing of a key, but they also have different triggering modes (LFO, Looping & Sequencer).

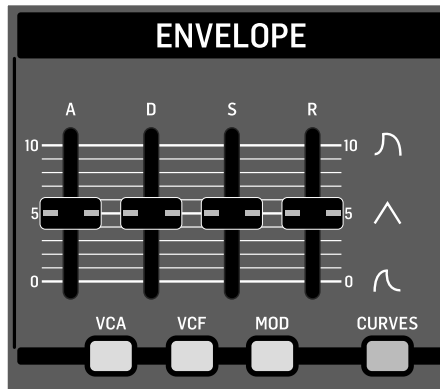

It is important to note that the ATTACK, DECAY and SUSTAIN stages are measured in units of time, and the SUSTAIN stage is measured in units of level.

The stages of the ENVELOPE are shown below:

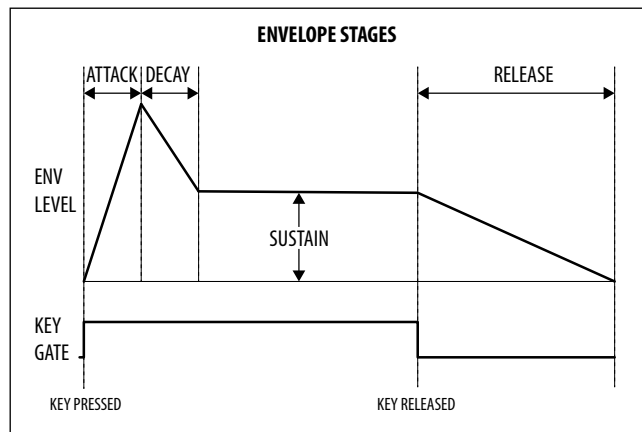

**Note:** In any of the looping modes the sustain stage is not considered and as soon as the envelope reaches the sustain stage it immediately starts the release stage.

### 8.8.1 VCA ENVELOPE SWITCH

To access the VCA ENVELOPE page press the VCA Envelope switch.

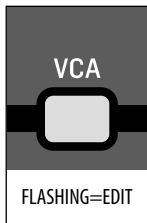

The VCA ENVELOPE switch will then start flashing and the VCA ENVELOPE menu is then shown:

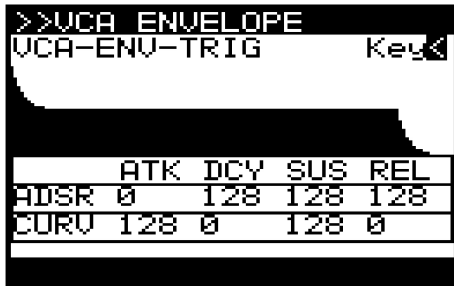

To navigate the options in the VCA ENVELOPE menu, use the UP, DOWN, switches.

Selected parameters are adjusted using the -NO/+YES switches, the rotary knob or the dedicated fader. The rotary knob has a click which allows very accurate control. The fader allows rapid adjustment across the full range:

The following options are available in the VCA ENVELOPE menu:

**VCA-ENV-TRIG** - This option allows you to select the triggering mode for the VCA ENVELOPE from the following:

- **Key** - This option will force the envelope to be triggered each time a key is pressed.
- **LFO-1** - This option will force the envelope to be triggered each time LFO 1 starts a new cycle.
- **LFO-2** - This option will force the envelope to be triggered each time LFO 2 starts a new cycle.
- **Loop** - This option will force the envelope to be re-triggered each time the end of the release stage is reached.
- **Seq** - This option will force the envelope to be re-triggered on every step of the CONTROL SEQUENCER.

**ADSR ATK:** - This controls the attack time of the VCA envelope. I.e. the time it takes for the sound to transition from zero to its maximum level. As the value increases, the slower the attack time becomes and the longer it takes for the sound to reach its maximum level.

**ADSR DCY:** This controls the decay time of the VCA envelope. After a sound reaches the maximum level, the decay time controls how quickly the level will transition to the sustain level. As the value increases, the longer the decay time becomes.

**ADSR SUS:** This controls the level for the sustain stage of the VCA envelope. The sound will stay at this level while a note is held on the keyboard.

**ADSR REL:** This option controls the release time of the VCA envelope. This controls how quickly it takes the sound to decay from the sustain level to zero when a key is released.

### 8.8.2 VCF ENVELOPE SWITCH

To access the VCF ENVELOPE page press the VCF ENVELOPE switch.

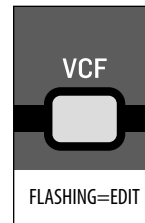

The VCF ENVELOPE switch will then start flashing and the VCF ENVELOPE menu is then shown:

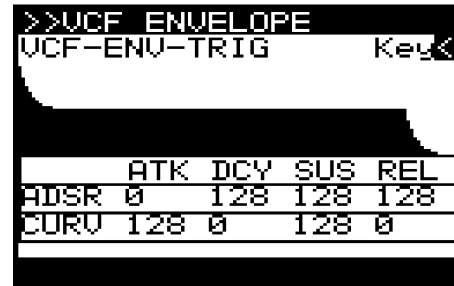

To navigate the options in the VCF ENVELOPE menu, use the UP, DOWN, switches.

Selected parameters are adjusted using the -NO/+YES switches, the rotary knob or the fader. The rotary knob has a click which allows very accurate control. The fader allows rapid adjustment across the full range:

The following options are available in the VCF ENVELOPE menu:

**VCF-ENV-TRIG** - This option allows you to select the triggering mode for the VCF ENVELOPE from the following:

- **Key** - This option will force the envelope to be triggered each time a key is pressed.
- **LFO-1** - This option will force the envelope to be triggered each time LFO 1 starts a new cycle.
- **LFO-2** - This option will force the envelope to be triggered each time LFO 2 starts a new cycle.
- **Loop** - This option will force the envelope to be re-triggered each time the end of the release stage is reached.
- **Seq** - This option will force the envelope to be re-triggered on every step of the CONTROL SEQUENCER.

**ADSR ATK:** This controls the attack time of the VCF envelope. I.e. the time it takes for the filter to open from the VCF FREQ fader setting to the level set by the VCF ENV fader. As the value increases, the slower the attack time becomes and the longer it takes for the filter to open.

**ADSR DCY:** Sets the decay time of the VCF envelope. After a sound reaches the frequency set at its attack stage, the decay controls how quickly the filter then transitions to the frequency set with the sustain knob.

**ADSR SUS:** Sets the filter cut-off frequency for the sustained portion of the sound. The sound will stay at this filter frequency for as long as a note is held on the keyboard.

**ADSR REL:** Sets the release time of the envelope. This controls how quickly the filter closes when a key is released.

## MOD ENVELOPE SWITCH

To access the MOD ENVELOPE page press the MOD ENVELOPE switch.

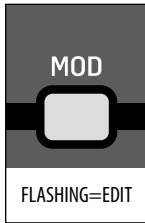

The MOD ENVELOPE switch will then start flashing and the MOD ENVELOPE menu is then shown:

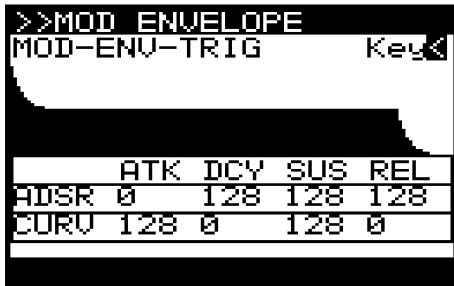

To navigate the options in the MOD ENVELOPE menu, use the UP, DOWN, switches.

Selected parameters are adjusted using the -NO/+YES switches, the rotary knob or the fader. The rotary knob has a click which allows very accurate control. The fader allows rapid adjustment across the full range:

The following options are available in the MOD ENVELOPE menu:

**MOD-ENV-TRIG** - This option allows you to select the triggering mode for the MOD ENVELOPE from the following:

- **Key** - This option will force the envelope to be triggered each time a key is pressed.
- **LFO-1** - This option will force the envelope to be triggered each time LFO 1 starts a new cycle.
- **LFO-2** - This option will force the envelope to be triggered each time LFO 2 starts a new cycle.
- **Loop** - This option will force the envelope to be re-triggered each time the end of the release stage is reached.
- **Seq** - This option will force the envelope to be re-triggered on every step of the CONTROL SEQUENCER.

**ADSR ATK:** - This controls the attack time of the MOD envelope. I.e. the time it takes for the envelope to reach its peak setting. As the value increases, the slower the attack time becomes and the longer it takes for the envelope to reach its maximum point.

**ADSR DCY:** This controls the decay time of the MOD envelope. After the envelope reaches the maximum value, the decay time controls how quickly the envelope will transition to the sustain level. As the value increases, the longer the decay time becomes.

**ADSR SUS:** This controls the value for the sustain stage of the MOD envelope. The sound will stay at this level while a note is held on the keyboard.

**ADSR REL:** This option controls the release time of the MOD envelope. This controls how quickly it takes the envelope to decay from the sustain value to zero when a key is released.

## 8.8.3 CURVES SWITCH

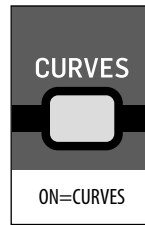

This switch changes the operation of the ADSR faders from adjusting the ADSR stages to adjusting the curve of each stage.

To activate CURVES mode press the CURVES switch. The switch will illuminate and the faders will now control the curve of each stage.

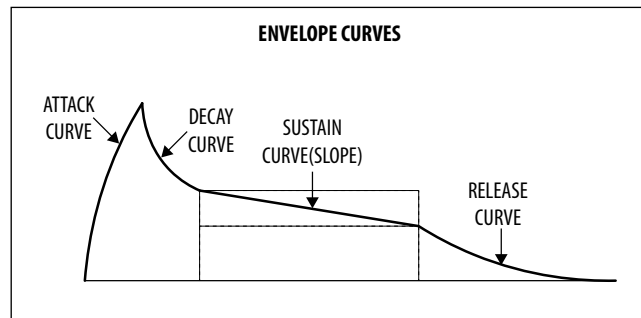

**CURV ATK:** This controls the curve shape of the attack stage.

**CURV DCY:** This controls the curve shape of the decay stage.

**CURV SUS:** This controls the curve shape (or slope) of the sustain stage.

**CURV REL:** This controls the curve shape of the release stage.

Using the curve functionality of the waveforms allows advanced sculpting of any of the envelopes. An example is shown below:

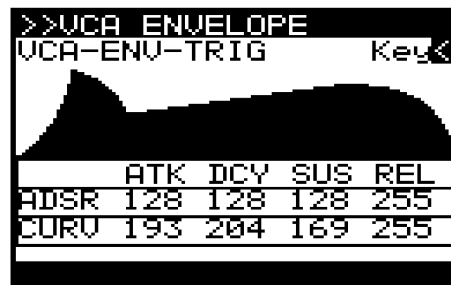

Note: When you adjust any of the envelope faders while viewing the PROG screen you will see a visualization of the envelope. Below the visualization you will see the standard or curve parameter values as shown below:

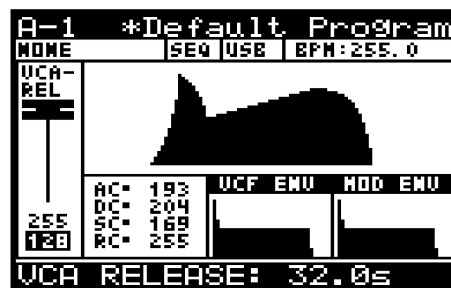

To return to normal operation of the ADSR stages press the CURVES switch again. The switch will no longer illuminate and the faders will now control the ADSR stages.

**Note:** The curve values and the respective response curves are shown below for guidance:

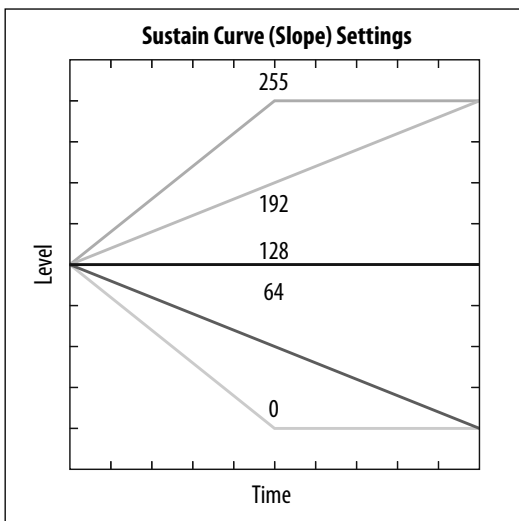
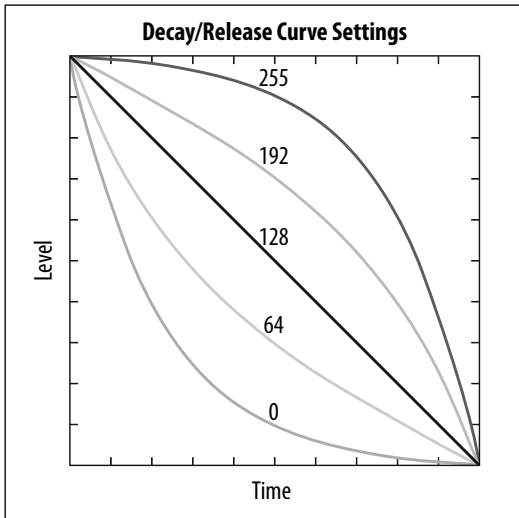
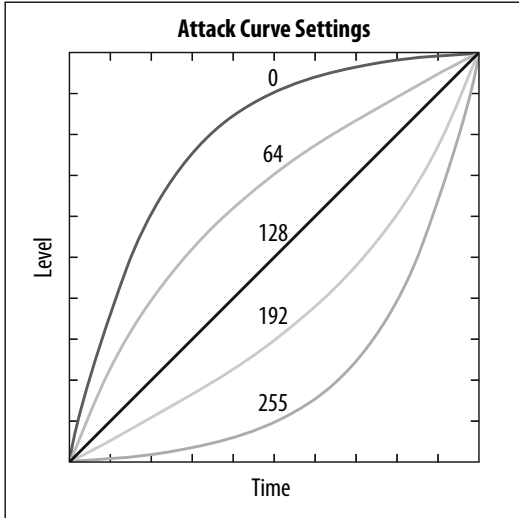

### 8.9 MOD MATRIX

The MODULATION MATRIX (MOD MATRIX) is one of the most powerful aspects of the DeepMind 12 synthesizer. To understand how and why the modulation matrix is so important we need to understand one simple concept, modulation. Modulation is the process of controlling one or more properties (destinations) of a signal using another signal (source).

A simple example would be the control of the VCF cut-off frequency by an sinusoidal LFO signal. The LFO would open and close the filter automatically which you could of course do by moving the fader manually. However, by using a modulation signal you not only free up your hands and mind, you also open up additional options such as:

- Synchronisation with other parameters and actions
- Speeds of modulation well past what you could achieve by hand
- Accuracy, or programmed inaccuracy of modulation signal
- Modulating multiple destinations from the same source
- Using multiple sources to modulate the same destination.
- Using a source to modulate a parameter e.g. LFO Rate, which indirectly affects another modulation e.g. Velocity to Attack Time.
- Using a source to modulate the depth of another modulation

Taking the concept further the DeepMind 12 offers a huge amount of sources and destinations. For a full list please consult the tables at the end of this section.

The DeepMind 12 MOD MATRIX allows creation of eight "busses". Each bus has a source, a destination modulations and a routing depth.

To access the MOD MATRIX page press the MOD switch.

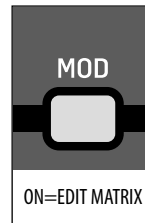

The MOD switch will then start flashing and the MOD MATRIX page is then shown:

```

>>MOD MATRIX (1-8)
SOURCE      DEPTH      DESTINATION
1 None      [ ] [ ]    None
2 None      [ ] [ ]    None
3 None      [ ] [ ]    None
4 None      [ ] [ ]    None
5 None      [ ] [ ]    None
6 None      [ ] [ ]    None
7 None      [ ] [ ]    None
8 None      [ ] [ ]    None
SRC-1      None
    
```

To navigate the options in the MOD MATRIX page, use the UP, DOWN, switches.

Selected parameters are adjusted using the -NO/+YES switches, the rotary knob or the fader. The rotary knob has a click which allows very accurate control. The fader allows rapid adjustment across the full range.

**MODULATION SOURCE** - To add a modulation source navigate to the source on the bus you wish to use and select the required source.

```
>>MOD MATRIX (1-8)
SOURCE DEPTH DESTINATION
1 Mod Wheel [ ] [ ] None
2 None [ ] [ ] None
3 None [ ] [ ] None
4 None [ ] [ ] None
5 None [ ] [ ] None
6 None [ ] [ ] None
7 None [ ] [ ] None
8 None [ ] [ ] None
SRC-1 Mod Wheel
```

**MODULATION ROUTING DEPTH** - To change the bus routing depth navigate to the source on the bus you wish to use and select the required source.

```
>>MOD MATRIX (1-8)
SOURCE DEPTH DESTINATION
1 Mod Wheel [ ] [+100] None
2 None [ ] [ ] None
3 None [ ] [ ] None
4 None [ ] [ ] None
5 None [ ] [ ] None
6 None [ ] [ ] None
7 None [ ] [ ] None
8 None [ ] [ ] None
DEPTH-1 +100
```

**MODULATION DESTINATION** - To add a modulation destination navigate to the destination on the bus you wish to use and select the required source.

```
>>MOD MATRIX (1-8)
SOURCE DEPTH DESTINATION
1 Mod Wheel [ ] [ ] UCF Freq
2 None [ ] [ ] None
3 None [ ] [ ] None
4 None [ ] [ ] None
5 None [ ] [ ] None
6 None [ ] [ ] None
7 None [ ] [ ] None
8 None [ ] [ ] None
DST-1 UCF Freq
```

**Note:** The possible modulation are 8 busses x 22 sources x 129 destinations which will allow over 22,000 possible combinations.

## 8.9.1 MODULATION SOURCES

The following modulation sources are available:

No	Name	Description
1	Pitch Bend	Pitch Bend Wheel
2	Mod Wheel	Modulation Wheel
3	Foot Ctrl	Foot Controller
4	BreathCtrl	Breath Controller
5	Pressure	Aftertouch Pressure
6	LF01	LF0 1
7	LF02	LF0 2
8	Env 1	VCA Envelope
9	Env 2	VCF Envelope
10	Env 3	Mod Envelope
11	Note Num	Note Number
12	Note Vel	Note Velocity
13	Ctrl Seq	Control Sequencer
14	LF01 (Uni)	LF01 (Unipolar)
15	LF02 (Uni)	LF0 2 (Unipolar)
16	LF01 (Fade)	LF0 1 (Fade Envelope)
17	LF02 (Fade)	LF0 2 (Fade Envelope)
18	NoteOffVel	Note Off Velocity
19	Voice Num	Voice Number
20	CC X (114)	Continuous Controller X-Axis (114)
21	CC Y (115)	Continuous Controller Y-Axis (115)
22	CC Z (116)	Continuous Controller Z-Axis (116)

## 8.9.2 MODULATION DESTINATIONS

The following modulation destinations are available:

No	Name	Description
1	LF01 Rate	LF0 1 Rate
2	LF01 Delay	LF0 1 Delay Time
3	LF01 Slew	LF0 1 Slew Rate
4	LF01 Shape	LF0 1 Shape
5	LF02 Rate	LF0 2 Rate
6	LF02 Delay	LF0 2 Delay Time
7	LF02 Slew	LF0 2 Slew Rate
8	LF02 Shape	LF0 2 Shape
9	OSC1+2 Pit	OSC 1 + 2 Pitch
10	OSC1 Pitch	OSC 1 Pitch
11	OSC2 Pitch	OSC 1 Pitch
12	OSC1 PM Dep	OSC 1 Pitch Modulation Depth
13	PWM Depth	OSC 1 Pulse Width Modulation Depth

No	Name	Description
14	TMod Depth	OSC 2 Tone Modulation Depth
15	OSC2 PM Dep	OSC 2 Pitch Modulation Depth
16	Porta Time	Portamento Time
17	VCF Freq	VCF Cut-off Frequency
18	VCF Res	VCF Resonance
19	VCF Env	VCF Envelope
20	VCF LFO	VCF LFO
21	Env Rates	All Envelope Rates
22	All Attack	All Attack Times
23	All Decay	All Decay Times
24	All Sus	All Sustain Levels
25	All Rel	All Release Times
26	Env1 Rates	All Envelope 1 Rates
27	Env2 Rates	All Envelope 2 Rates
28	Env3 Rates	All Envelope 3 Rates
29	Env1CurveS	All Envelope 1 Curves
30	Env2CurveS	All Envelope 2 Curves
31	Env3CurveS	All Envelope 3 Curves
32	Env1 Attack	Envelope 1 Attack Time
33	Env1 Decay	Envelope 1 Decay Time
34	Env1 Sus	Envelope 1 Sustain Level
35	Env1 Rel	Envelope 1 Release Time
36	Env1 AtCur	Envelope 1 Attack Time Curve
37	Env1 DcyCur	Envelope 1 Decay Time Curve
38	Env1 SuSCur	Envelope 1 Sustain Level Curve
39	Env1 RelCur	Envelope 1 Release Time Curve
40	Env2 Attack	Envelope 2 Attack Time
41	Env2 Decay	Envelope 2 Decay Time
42	Env2 Sus	Envelope 2 Sustain Level
43	Env2 Rel	Envelope 2 Release Time
44	Env2 AtCur	Envelope 2 Attack Time Curve
45	Env2 DcyCur	Envelope 2 Decay Time Curve
46	Env2 SuSCur	Envelope 2 Sustain Level Curve
47	Env2 RelCur	Envelope 2 Release Time Curve
48	Env3 Attack	Envelope 3 Attack Time
49	Env3 Decay	Envelope 3 Decay Time
50	Env3 Sus	Envelope 3 Sustain Level
51	Env3 Rel	Envelope 3 Release Time
52	Env3 AtCur	Envelope 3 Attack Time Curve
53	Env3 DcyCur	Envelope 3 Decay Time Curve
54	Env3 SuSCur	Envelope 3 Sustain Level Curve

No	Name	Description
55	Env3 RelCur	Envelope 3 Release Time Curve
56	VCA All**	VCA Gain for All Voices
57	VCA Active**	VCA Gain for Active Voices
58	VCA EnvDep	VCA Envelope Depth
59	Pan Spread	Pan Spread
60	VCA Pan	VCA Pan
61*	OSC2 Lvl	OSC 2 Level
62*	Noise Lvl	Noise Level
63*	HP Freq	HPF Cut-off Frequency
64*	Uni Detune	Unison Detune
65*	OSC Drift	OSC Drift
66*	Param Drift	Parameter Drift
67*	Drift Rate	Drift Rate
68*	Arp Gate	Arpeggiator Gate
69*	Seq Slew	Control Sequencer Slew
70	Mod 1 Dep	Mod Matrix Routing 1 Depth
71	Mod 2 Dep	Mod Matrix Routing 2 Depth
72	Mod 3 Dep	Mod Matrix Routing 3 Depth
73	Mod 4 Dep	Mod Matrix Routing 4 Depth
74	Mod 5 Dep	Mod Matrix Routing 5 Depth
75	Mod 6 Dep	Mod Matrix Routing 6 Depth
76	Mod 7 Dep	Mod Matrix Routing 7 Depth
77	Mod 8 Dep	Mod Matrix Routing 8 Depth
78-89	Fx 1 Params	Effects Slot 1 Parameters
90-101	Fx 2 Params	Effects Slot 2 Parameters
102-113	Fx 3 Params	Effects Slot 3 Parameters
114-125	Fx 4 Params	Effects Slot 4 Parameters
126	Fx 1 Level	Effects Slot 1 Level
127	Fx 2 Level	Effects Slot 2 Level
128	Fx 3 Level	Effects Slot 3 Level
129	Fx 4 Level	Effects Slot 4 Level

**Note:** Destinations marked with a '\*' are common to all voices.

\*\* VCA Active - This destination affects the VCA Gain for all active voices.

\*\*\* VCA All - This destination affects the VCA Gain for all voices, regardless of whether they are active or not.

## 9. Effects Reference Guide

### 9.1 Effects Table

No	Name	Description	Device Inspiration	Type
1	TC-DeepVRB	TC Deep Reverb	TC Hall of Fame	Reverb
2	AmbVerb	Ambient Reverb	Lexicon 480L	Reverb
3	RoomRev	Room Reverb	Lexicon 480L	Reverb
4	VintageRev	Vintage Room Reverb	EMT250	Reverb
5	HallRev	Hall Reverb	Lexicon 480L	Reverb
6	ChamberRev	Chamber Reverb	Lexicon 480L	Reverb
7	PlateRev	Plate Reverb	Lexicon PCM-70	Reverb
8	RichPltRev	Rich Plate Reverb	Lexicon 480L	Reverb
9	GatedRev	Gated Reverb	Lexicon 300/480L	Reverb
10	Reverse	Reverse Reverb	Lexicon 300/480L	Reverb
11	ChorusVerb	Chorus & Reverb	Lexicon PCM-70	Reverb
12	DelayVerb	Delay & Reverb	Lexicon PCM-70	Reverb
13	FlangVerb	Flange & Reverb	Lexicon PCM-70	Reverb
14	MidasEQ	Midas Equaliser	Midas ProX*	Processing
15	Enhancer	Enhancer	SPL Vitalizer	Processing
16	FairComp	Fair Compressor	Fairchild 670	Processing
17	MulBndDist	Multi-Band Distortion	Midas ProX*	Processing
18	RackAmp	Rack Amplifier	Tech 21 SansAmp	Processing
19	EdisonEX1	Stereo Imaging	Edison EX-1	Processing
20	Auto Pan	Auto-Panning	Behringer X32*	Processing
21	NoiseGate	Noise Gate	Midas ProX*	Processing
22	Delay	Delay	Behringer X32*	Delay
23	3TapDelay	3-Tap Delay	Behringer X32*	Delay
24	4TapDelay	4-Tap Delay	Behringer X32*	Delay
25	T-RayDelay	Tel-Ray Delay	Tel-Ray Delay	Delay
26	DecimDelay	Decimator Delay	Decimator Delay	Delay
27	ModDlyRev	Mod, Delay & Reverb	Lexicon PCM-70	Delay
28	Chorus	Chorus	Behringer X32*	Creative
29	Chorus-D	Chorus D	Roland Dimension D	Creative
30	Flanger	Flanger	Behringer X32*	Creative
31	Phaser	Phase	Behringer X32*	Creative
32	MoodFilter	Mood Filter	Moog Type Filter	Creative
33	DualPitch	Dual Pitch Shifter	Harmonizer	Creative
34	RotarySpkr	Rotary Speaker	Leslie	Creative

\* - Direct algorithms from the hardware devices designed by Music Group companies.

### 9.2 Effects Descriptions

Here is a list and brief description of the effects available on the DeepMind 12 synthesizer.

#### TC Deep Reverb



TC Electronic is synonymous with some of the best sounding reverbs out there. There are nine iconic reverb modes you know and love into this effect that simply sounds so insanely good – you just have to try it. It's amazing that just four controls (Decay, Tone and PreDelay) can give such a wide range of tonal options – bright and springy, warm and bouncy or gigantic dark reflections... It's all there – and then some.

The PRE DELAY fader controls the amount of time before the reverb is heard following the source signal. TONE enhances high frequencies for positive settings and enhances low frequencies for negative settings. DECAY controls the amount of time it takes for the reverb to dissipate. Note: The decay range changes depending which of the modes is selected.

#### HallRev, AmbVerb, RichPltRev, RoomRev, ChamberRev



These 5 reverb emulations are inspired by the Lexicon 480L. Hall simulates the reverberation that occurs when sound is recorded in medium to large-sized concert halls. Ambience creates a customizable virtual acoustic space to add warmth and depth without coloring the direct sound.

The PRE DELAY fader controls the amount of time before the reverb is heard following the source signal. DECAY controls the amount of time it takes for the reverb to dissipate. SIZE controls the perceived size of the space being created by the reverb. The DAMP fader adjusts the decay of the high frequencies within the reverb tail. DIFF(usion) controls the initial reflection density, and LEVEL controls the effect output.

LO and HI CUT allow the frequencies affected by the reverb to be narrowed. BASSMULT(plier) controls the low frequency build-up. SPREAD emphasizes the stereo effect of the reverb. SHAPE adjusts the contour of the reverberation envelope. MOD SPEED controls the reverb tail modulation rate and TAIL GAIN adjusts the volume of the reverb tail. The Rich Plate and Room reverbs allow the stereo ECHO DELAY and the delay FEEDBACK to be adjusted independently for each side. The Chamber reverb allows the stereo REFL(ection) DELAY and GAIN to be adjusted independently.

#### VintageRev



Vintage Room simulates the reverberation that occurs when sound is recorded in a small room. When you want to add a bit of warmth and just a touch of reverb, the Vintage Room breathes life into close-mic'd guitar and drum tracks. (Inspired by the Quantec QRS)

Set the early reflection times for the left and right channel with ER DELAY L and ER DELAY R. ER LEVEL sets the loudness of the early reflection level. REV DELAY controls the amount of time before the reverberation is heard following the source signal. HI/LOW MULTIPLY adjusts the decay time of the high and bass frequencies. ROOM SIZE adjusts the size of the room effect being created incrementally from small to large. HIGH CUT sets the frequency above which the source signal does not pass through the reverb. DENSITY manipulates the reflection density in the simulated room. (This slightly changes the reverb decay time). LOW CUT sets the frequency below which the source signal does not pass through the reverb.

## Plate Reverb



A plate reverb was originally created by sending a signal through a transducer to create vibrations on a plate of sheet metal which were then picked up as an audio signal. Our algorithm simulates that sound with high initial diffusion and a bright colored sound. The Plate Reverb will give your tracks the sound heard on countless hit records since the late 1950s. (Inspired by the Lexicon PCM-70)

PRE DELAY controls the amount of time before the reverberation is heard following the source signal. DECAY controls the amount of time it takes for the reverb to dissipate. SIZE adjusts the size of the virtual room created by the reverb effect. The DAMP knob adjusts the decay of high frequencies within the reverb tail. DIFF(USION) controls the initial reflection density. The LO CUT knob sets the frequency beneath which the source signal will not pass through the reverb. The HI CUT knob sets the frequency above which the source signal will not pass through the reverb. The BASS MULT(IPLIER) knob adjusts the decay time of the bass frequencies. XOVER controls the crossover point for bass. MOD DEPTH and SPEED control the intensity and speed of the reverb tail modulation.

## Gated Reverb



This effect was originally achieved by combining a reverb with a noise gate. Our gated reverb creates the same impression by a special shaping of the reverb tail.

Gated Reverb is especially effective for creating a 1980s-style snare sound or to enlarge the presence of a kick drum. (Inspired by the Lexicon 300/480L)

PRE DELAY controls the amount of time before the reverberation is heard following the source signal. DECAY controls the amount of time it takes for the reverb to dissipate. ATTACK controls how fast the reflection density builds up. DENSITY shapes the reverb decay tail. The higher the density, the greater the number of sound reflections. SPREAD controls how the reflection is distributed through the envelope of the reverb. The LO CUT knob sets the frequency beneath which the source signal will not pass through the reverb. The HiSvFr/ HiSvGn knobs adjust a Hi-Shelving filter at the input of the reverb effect. DIFF(USION) controls the initial reflection density.

## Reverse Reverb



Reverse Reverb takes the trail of a reverb, turns it around, and places it in front of the sound source. Use the swelling crescendo of the Reverse Reverb to add an ethereal quality to vocal and snare tracks. (Inspired by the Lexicon 300/480L)

Adjusting the PRE DELAY knob adds up to 200 milliseconds of time before the reverb follows the source signal. The DECAY knob adjusts the time it takes for the reverb to completely dissipate. RISE controls how quickly the effect builds up. DIFF(USION) controls the initial reflection density. SPREAD controls how the reflection is distributed through the envelope of the reverb. The LO CUT knob sets a low frequency beneath which the source signal will not pass through the reverb. The HiSvFr/HiSvGn knobs adjust a Hi-Shelving filter at the input of the reverb effect.

## Chorus + Chamber



Taking up only one FX slot, the Chorus + Chamber effect combines the shimmer and doubling characteristics of a studio-grade Chorus with the sweet sound of a traditional Chamber reverb. (Reverb is Inspired by the Lexicon PCM 70)

The BALANCE knob adjusts the balance between chorus and reverb. Low frequencies can be excluded with the LO CUT knob, and the MIX knob adjusts how much of the effect is added to the signal. SPEED, DELAY and DEPTH adjust the rate, delay, and modulation depth of the chorus. The LFO PHASE between left and right channel can be offset by up to 180 degrees, and WAVE adjusts the LFO waveform from a sine wave to triangular wave. The PREDELAY knob determines the hesitation before the reverb affects the signal. The DECAY knob adjusts how quickly the reverb fades. The SIZE controls how large or small the simulated space is (room, cathedral, etc.). The DAMPING knob determines the decay of high frequencies within the reverb tail.



## Delay + Chamber



Here we have combined Delay and Chamber reverb, so a single device can provide a variety of delay settings, plus add just the right type and amount of reverb to the selected signal. This device only uses one FX slot. (The Reverb is Inspired by the Lexicon PCM 70)

Use the **BALANCE** knob to adjust the ratio between delay and reverb. Low frequencies can be excluded with the **LO CUT** knob, and the **MIX** adjusts how much of the effect is added to the signal. The **TIME** knob adjusts the delay time for the left channel delay, and the **PATTERN** sets the delay ratio for the right channel delay. Adjust the **FEEDBACK** and trim some high frequencies with the **FEED HC** (high-cut) knob. The **XFEED** knob allows you to send the delay sound to the reverb effect, so instead of running completely parallel, the reverb affects the echoes to a selected degree. The **PREDELAY** knob determines the hesitation before the reverb affects the signal. The **DECAY** knob adjusts how quickly the reverb fades. The **SIZE** controls how large or small the simulated space is (room, cathedral, etc.). The **DAMPING** knob determines the decay of high frequencies within the reverb tail.

## Flanger + Chamber



Add the mind-bending, filter-sweeping effect of a state-of-the-art Flanger to the elegant sweetening of a traditional Chamber reverb — all in one FX slot. (Reverb is Inspired by the Lexicon PCM 70)

The **BALANCE** knob adjusts the ratio between flanger and reverb. Low frequencies can be excluded with the **LO CUT** knob, and the **MIX** knob adjusts how much of the effect is added to the signal. **SPEED**, **DELAY** and **DEPTH** adjust the rate, delay, and modulation depth of the flanger. **FEEDBACK** can be adjusted with positive and negative amounts. The **PHASE** can be off set by up to 180 degrees. The **PREDELAY** knob determines the hesitation before the reverb affects the signal. The **DECAY** knob adjusts how quickly the reverb fades. The **SIZE** controls how large or small the simulated space is (room, cathedral, etc.). The **DAMPING** knob determines the decay of high frequencies within the reverb tail.

## MidasEQ



The Midas EQ is a four-band sweep parametric equalizer taken from the Midas Pro X console that allows tonal control of the input signal via the parametric EQ section. The mid bands also have a Q Factor adjustment to tailor the shape of the EQ curve. The four bands are low, low mid, high mid and high. Any combination of the four bands can be used to control the signal.

## Enhancer



These Enhancers are so called “Psycho EQs”. They can enhance the signal spectrum in bass, midrange and high frequencies but they differ from traditional equalizers. When you need to generate maximum punch, clarity and detail, without turning up the overall volume, our enhancers are the solution. (Inspired by the SPL Vitalizer)

Adjust the **BASS**, **MID** and **HI GAIN** knobs to add or reduce content in those spectrums. The **BASS** and **HI** Frequencies can be specifically selected, while the **MID Q** (bandwidth) can be adjusted instead. The **OUT GAIN** knob compensates for changes in level resulting from the effect, and the **SPREAD** knob (Stereo version only) emphasizes the stereo content for a wider mix. Engage the **SOLO MODE** to isolate only the audio resulting from the effect so you can hear exactly what you’re adding to the mix.

## Fair Compressor



This model of a Fairchild 670 delivers some of the finest colorations in compressor history. The two paths **L/M** and **R/S** both have the same functionality. The controls include **input GAIN**, **THRESHOLD**, **TIME** and **DC BIAS** (which controls the ratio and knee of the compression curve). There is also a **BIAS BALANCE** which can help accentuate attacks. There are modes available for dual, stereo-linked, or mid/side operation via the **MOD** control.

## MulBndDist



The Multiband Distortion unit, useful for making sound gritty, adding more warmth through saturation, or even enhancing a specific frequency region. There are three bands, adjustable by a 24 dB per octave crossover filter.

There are six distortion types, going from soft saturation to more aggressive distortion and post filter variants. The ‘Drive’ parameter controls the amount of distortion introduced to the sound. This parameter, together with the right distortion type, can instead bring some soft saturation to the sound.

The effect also features a **Cabinet Unit** applied to the output, which can add the characteristic timbre of 11 different cabinet types.

Finally the level of the sound can be controlled by the input and output gain parameters.

## Rack Amplifier



Modelled after the Tech 21 SansAmp, the Stereo / Dual Guitar Amp simulates the sound of plugging into a real guitar amp. From shimmering cleans to saturated crunch, the Stereo / Dual Guitar Amp allows an electric guitar player to sound great without using an amp on stage. The PREAMP knob adjusts the amount of input gain prior to the band-specific distortion adjustment. BUZZ adjusts the low-end breakup, PUNCH adjusts the midrange distortion, and CRUNCH tailors the high-frequency content and distortion for smooth or cutting notes. The DRIVE knob simulates the amount of power amp distortion from a tube amp. The LOW and HIGH knobs allow EQ adjustment independent of distortion content, and the overall output is controlled by the LEVEL knob. There are 11 CABINET emulations which can be selected using the CAB parameter. The CABINET simulation can also be bypassed which allows the effect to function like a boost or distortion pedal.

## Edison EX1



The EDISON EX1+ is a remarkably effective tool that allows manipulation of the stereo field. The effect offers stereo and mid/side input and output and a phase correlation meter. Exaggerate the stereo field with the ST SPREAD knob and adjust the ratio of mono to stereo content with the BALANCE knob. The CENTER DIST knob allows the mono content to be panned. Compensate for level changes with the OUTPUT GAIN knob.

## Auto-Pan



Auto-pan creates an up and down volume change at a constant and even tempo just like the guitar amps of yesteryear. Use the Auto-pan to add a unique “surf-music” texture.

SPEED adjusts the LFO rate and DEPTH sets the amount of modulation. PHASE can be used to set an LFO phase difference between the left and right channel, which can be used for panning effects. The WAVE knob blends the LFO waveform between triangular and square shape. The signal envelope, shaped by ATTACK, HOLD and RELEASE, can be used to modulate the LFO speed (ENV SPEED) and the LFO modulation depth (ENV DEPTH).

## NoiseGate



The Noise Gate not only handles the duties of a traditional version, but also offers enhanced "Transient Accenting" characteristics to gated signals. Enhance the attack envelope beyond merely opening the gate, and provide up to 12 dB of additional transient energy to percussive programs. In many cases the DN265's control over transients may prove to be a viable alternate to EQ.

Attack is exponential which means it can be set extremely fast to reduce signal loss at the start of sounds while remaining sonically transparent - no clicks.

Gate release is reverse exponential so it can be set relatively fast and blend in seamlessly with the natural decay of the material.

## Delay

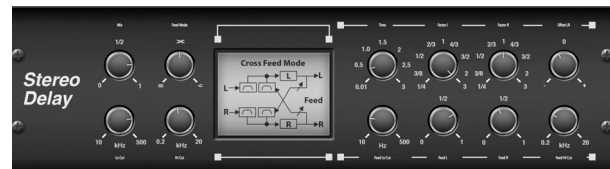

Stereo Delay provides independent control of left and right delay (echo) times and features high and low pass filters for enhanced tone shaping of the delayed signals. Use the Stereo Delay to give your mono signals a wide presence in the stereo field.

The MIX control lets you blend the source signal and the delayed signal. TIME adjusts the master delay time up to three seconds. LO CUT adjusts the low frequency cut, allowing lower frequencies to remain unaffected by the delay. HI CUT adjusts the high frequency cut, allowing higher frequencies to remain unaffected by the delay. FACTOR L sets the delay on the left channel to rhythmic fractions of the master delay time. FACTOR R sets the delay on the right channel to rhythmic fractions of the master delay time. OFFSET LR adds a delay difference between the left and right delayed signals. The FEED LO CUT/HI CUT adjusts filters in the feedback paths. FEED L and FEED R control the amount of feedback for the left and right channels. MODE sets the feedback mode: Mode ST sets normal feedback for both channels, X crosses feedbacks between left and right channels. M creates a mono mix within the feedback chain.

## 3-Tap Delay



Sometimes called a 3-Tap Delay, the Triple Delay provides three delay stages with independent frequency, gain, and pan controls. Create time-based echo effects with the Triple Delay to increase the sense of stereo separation.

TIME sets the master delay time, which is also the delay time for the first stage. GAIN T sets the gain level of the first stage of the delay. BASE T sets the position of the first delay stage in the stereo field. X-FEED indicates that stereo cross-feedback of the delays is active. FEEDBACK adjusts the amount of feedback. FACTOR A controls the amount of delay time in the second stage of the delay. GAIN A controls the gain level of the second delay stage. PAN A sets the position of the second delay stage in the stereo field. FACTOR B controls the amount of delay time in the third stage of the delay. GAIN B controls the gain level of the third delay stage. PAN B sets the position of the third gain stage in the stereo field.

## 4-Tap Delay



The 4-Tap Delay provides 4 stages of delay with independently adjustable gain and rate, allowing unique syncopation to be created in the layered repeats.

TIME sets the master delay time, which is also the delay time for the first stage. GAIN sets the gain for the first stage. SPREAD positions the first delay stage in the stereo field. A global FEEDBACK adjustment is also available. FACTOR A, B and C adjust the delay rate relative to the global TIME setting for the 2nd, 3rd and 4th stages respectively. Each stage also has its own GAIN adjustment. X-FEED indicates that stereo cross-feedback of the delays is active.

## Tel-Ray Delay



Inspired by the original Tel-Ray hardware from the 1960's using a tuna can, some oil and a motor. It has a very simple set of controls but allows you to create delays, echo, chorus, vibrato and reverb type effects. An incredibly versatile and creative effect which has a lush and unique character.

DELAY controls the delay time. SUSTAIN controls how long the delay is sustained for. WOB controls the amount of wobble which is caused by age and quality of materials in the original hardware.

## Decimator Delay



This is a delay effect including a decimator unit in its chain. It will decimate the sound by reducing the sampling frequency and the bit-depth. The Decimator Delay is a creative tool that can be used in many ways, from emulating the aliasing noise, found in older samplers, to generating complex, low-fi and rough delay lines.

Decimate the sound by adjusting the DOWNSAMPLE and BIT-REDUCE. The filter section will help you manipulate your preferred frequencies to smooth or retain the grittiness of the sound. The TIME, FACTOR and FEEDBACK parameters will handle the delay behavior. The DECIMATE (PRE-POST) parameter will set the decimation to affect the input source or the only the delay line accordingly.

## Modulation Delay + Reverb



Modulation Delay combines three of the most used time modulation effects into one easy-to-operate unit, featuring true-stereo delay with a lush chorus, topped off with three reverb models to choose from.

The BALANCE knob adjusts ratio of delay to reverb. The processor chain can operate as serial where one effect flows into the next, or parallel where each effect is applied to the source signal independently. TIME, FEED(back), LOW and HI CUT all affect the delay. Modulation DEPTH and SPEED are adjustable. Three types of reverb are available – ambience, club and hall – with adjustable DECAY and HI DAMP.

## Chorus



Chorus samples the input, slightly detunes it and mixes it with the original signal to produce a somewhat thicker, shimmering sound. Use it to thicken up background vocals, or to double the sound of brass and woodwind instruments.

Where as DELAY L/R set the total amount of delay for the left and right channel, WIDTH determines the amount of modulated delay. SPEED sets the modulation speed. MIX adjusts the balance of the dry and wet signals. You can further sculpt the sound by trimming some of the low and high end from the effected signal with the LO and HI CUT knobs. Additionally, the PHASE knob can tweak the phase offset of the LFO between left and right channel and the SPREAD knob adjusts how much of the left channel is mixed into the right and vice versa. Finally, the WAVE knob blends between the “Danish-style” digital triangular chorus sound and the classic analog sine wave.

## Dimensional Chorus



The Dimensional Chorus offers the most user-friendly and classic sounds, best described as “space” and “dimensional”. The 4 MODE switches can be engaged individually or simultaneously for light chorus or very thick, exaggerated modulation.

## Flanger



The Flanger emulates the phase-shifting sound (comb-filtering) originally created by applying pressure against the flange of the reel on a tape recorder. This effect creates a unique “wobbly” sound that is quite dramatic when used on vocals and instruments.

The controls of this effect are nearly identical to the Chorus effect block. Additionally, the FEEDBACK can be adjusted with positive and negative amounts and also band-limited with the FEED HC (high-cut) and FEED LC (low-cut) knobs.

## Phaser



A Stereo Phaser, or phase shifter, applies multiple STAGES of modulated filters to the input signal to create a “notch” in the frequency response, and then applies a MIX with the original for a “swirling” effect. Use the Stereo Phaser to add a “spaced-out” sound to vocal or instrument tracks.

SPEED adjusts the LFO rate and DEPTH sets the LFO modulation depth. The BASE knob adjusts the frequency range of the modulated filters. The resonance is adjusted with the RESO knob. The WAVE knob shapes the symmetry of the LFO waveform and PHASE dials in an LFO phase difference between the left and right channel. The modulation source can also be the signal envelope, which produces vowel-like opening and closing tones. The ENV knob adjusts how much this effect takes place (positive and negative modulation is possible), and the ATTACK, HOLD and RELEASE knobs all tailor the response of this feature.

## Mood Filter



The Mood Filter uses an LFO generator and an auto-envelope generator to control a VCF (voltage-controlled filter), as well as a side chain function where the channel B signal controls the envelope of channel A.

This filter can be modulated with the signal’s envelope using the ENV MOD (with positive and negative amounts), ATTACK and RELEASE knobs, or the LFO can modulate the filter. The WAVE knob selects between 7 different wave forms – triangular, sine, saw plus, saw minus, ramp, square, and random. The PHASE can be off set by up to 180 degrees. The SPEED knob adjusts the rate of the LFO and the DEPTH adjusts the amount of LFO modulation. Adjust the resonance of the filter until self-oscillation with the RESO(nance) knob. BASE adjusts the range of the filter from 20 Hz to 15 kHz. The MODE switch selects between low pass (LP), high-pass (HP), band-pass (BP) and Notch. Use the MIX knob to blend the effected signal with the dry sound. With the 4 POLE switch engaged, there will be a steeper slope than the OFF (2 pole) setting. The DRIVE knob adjusts the level and can also introduce an overdrive effect (as with real analog filters) if pushed hard.

## Stereo / Dual Pitch



Pitch shifting is often used in two different ways. One is to set the Mix knob lower and only use the Cent knob to make a small off set in pitch between the wet and dry tones. This results in a “voice doubling” effect that thickens the overall sound in a more subtle way. The extreme use of the effect is to turn the Mix knob fully clockwise so the entire signal is effected. This way, the signal can be shifted into other keys up to an octave above or below the original. When used on a voice, this results in a “chipmunk” sound or a low Darth Vader effect.

When the SEMI and CENT knobs are set at 12:00, the pitch is not altered. Making adjustments by semitone will have a very pronounced effect, whereas changes to the CENT knob will be very minor. The DELAY knob creates a time difference between the wet and dry sound. The LO and HI CUT knobs allow the effected signal to be band-limited. The Dual Pitch effect allows the left and right channels to be adjusted independently, and allows GAIN compensation and panning of the two channels.

## Rotary Speaker



Rotary Speaker emulates the sound of a Leslie rotating speaker. The Rotary Speaker provides more flexibility than its electromechanical counterpart, and can be used with a variety of instruments, and even vocals, to create a whirling, psychedelic effect.

The LO SPEED and HI SPEED knobs adjust the rotational speed of the SLOW and FAST Speed selection, and can be toggled with the FAST switch. The ACCEL(eration) knob adjusts how quickly the speed increases and decreases from the Slow mode to the Fast mode. The rotation effect can also be disengaged with the STOP switch, which will stop the movement of the speakers. DISTANCE adjusts the distance between the Rotary speakers and the virtual microphone.

## 9.3 Effects Parameters

**Note:** Effects parameters which appear as modulation destinations are marked with a <sup>\*</sup>.

### TC-DeepVRB (TC DEEP REVERB)

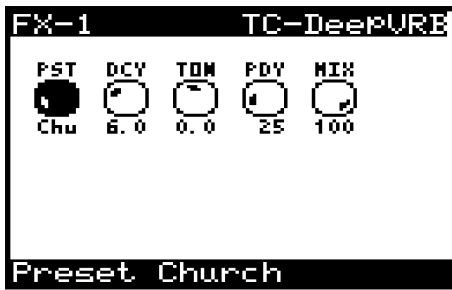

No	DM12 REF	PARAMETER	UNITS	MIN	MAX	DESCRIPTION
1	PST	Preset	—	—	—	Options: Ambience, Church, Gate, Hall, Lo Fi, Modulated, Plate, Room, Spring, Tile, Default.
2*	DCY	Decay	s	0.1 s	6.0 s	Controls the amount of time it takes for the reverb to dissipate (range is preset dependant).
3*	TON	Tone	%	-50.0%	50.0%	Enhances high frequencies/low frequencies for positive/negative settings respectively.
4	PDY	PreDelay	ms	0.0	200.0 ms	Controls the amount of time before the reverb is heard following the source signal.
5*	MIX	Mix	%	0.0%	100%	Controls the mix (or ratio) of wet (processed) and dry (unprocessed) signals.

### AmbVerb (AMBIENT REVERB)

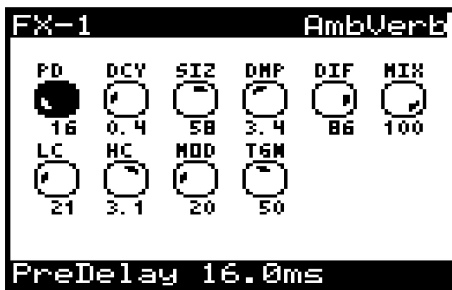

No	DM12 REF	PARAMETER	UNITS	MIN	MAX	DESCRIPTION
1	PD	PreDelay	ms	0.0	200.0 ms	Controls the amount of time before the reverb is heard following the source signal.
2*	DCY	Decay	s	0.2 s	7.3s	Controls the amount of time it takes for the reverb to dissipate.
3	SIZ	Size	—	2.0	100.0	Controls the perceived size of the space being created by the reverb.
4*	DMP	Damping	Hz	1000 Hz	20000 Hz	Adjusts the decay of the high frequencies within the reverb tail.
5	DIF	Diffusion	—	1.0	30.0	Controls the initial reflection density.
6*	MIX	Mix	%	0.0%	100%	Controls the mix (or ratio) of wet (processed) and dry (unprocessed) signals.
7*	LC	LoCut	Hz	10.0 Hz	500.0 Hz	Allows the low frequencies affected by the reverb to be reduced.
8*	HC	Hi Cut	Hz	200.0 Hz	20000.0 Hz	Allows the high frequencies affected by the reverb to be reduced.
9	MOD	Mod	%	0.0%	100%	Controls the reverb tail modulation depth.
10*	TGN	TailGain	%	0.0%	100%	Adjusts the volume of the reverb tail.

## RoomRev (ROOM REVERB)

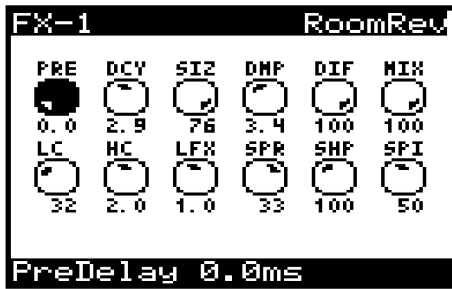

No	DM12 REF	PARAMETER	UNITS	MIN	MAX	DESCRIPTION
1	PRE	PreDelay	ms	0.0	200.0 ms	Controls the amount of time before the reverb is heard following the source signal.
2*	DCY	Decay	s	0.3 s	28.9 s	Controls the amount of time it takes for the reverb to dissipate.
3	SIZ	Size	m	4.0 m	76.0 m	Controls the perceived size of the space being created by the reverb.
4*	DMP	Damping	Hz	1000 Hz	20000 Hz	Adjusts the decay of the high frequencies within the reverb tail.
5	DIF	Diffusion	%	0.0%	100%	Controls the initial reflection density.
6*	MIX	Mix	%	0.0%	100%	Controls the mix (or ratio) of wet (processed) and dry (unprocessed) signals.
7*	LC	LoCut	Hz	10.0 Hz	500.0 Hz	Allows the low frequencies affected by the reverb to be reduced.
8*	HC	Hi Cut	Hz	200.0 Hz	20000.0 Hz	Allows the high frequencies affected by the reverb to be reduced.
9*	LFX	BassMult	--	0.2	4.0	Controls the low frequency build-up.
10	SPR	Spread	--	0.0	50.0	Emphasizes the stereo effect of the reverb.
11*	SHP	Shape	--	0.0	250.0	Adjusts the contour of the reverberation envelope.
12	SPI	Spin	%	0.0%	100%	Controls randomization / modulation effects within the reverb.

## VintageRev (VINTAGE ROOM REVERB)

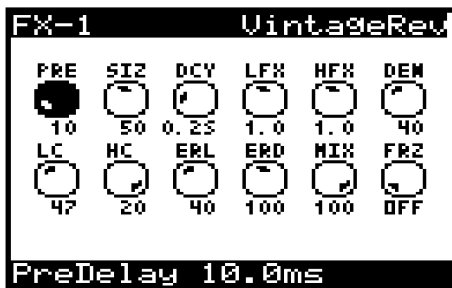

No	DM12 REF	PARAMETER	UNITS	MIN	MAX	DESCRIPTION
1	PRE	PreDelay	ms	0.0	200.0 ms	Controls the amount of time before the reverb is heard following the source signal.
2	SIZ	Size	%	1.0%	100%	Controls the perceived size of the space being created by the reverb. Affects DECAY range.
3*	DCY	Decay	s	0.1 s	20.7 s	Controls the amount of time it takes for the reverb to dissipate. Range dependant on SIZE.
4*	LFX	Lo Mult	--	0.1	10.0	Controls the low frequency build-up.
5*	HFX	Hi Mult	--	0.1	10.0	Controls the high frequency build-up.
6*	DEN	Density	%	0.0%	100%	Manipulates the reflection density in the simulated room.
7*	LC	LoCut	Hz	10.0 Hz	500.0 Hz	Allows the low frequencies affected by the reverb to be reduced.
8*	HC	Hi Cut	Hz	200.0 Hz	20000.0 Hz	Allows the high frequencies affected by the reverb to be reduced.
9*	ERL	ER Level	%	0.0%	100%	Set the early reflection times.
10	ERD	ER Delay	ms	0.0	200.0 ms	Sets the loudness of the early reflection level.
11*	MIX	Mix	%	0.0%	100%	Controls the mix (or ratio) of wet (processed) and dry (unprocessed) signals.
12*	FRZ	Freeze	--	OFF	ON	Applies freeze mode and blends signals into a continuous response.

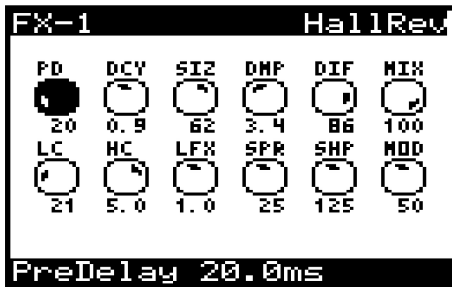
**HallRev (HALL REVERB)**

No	DM12 REF	PARAMETER	UNITS	MIN	MAX	DESCRIPTION
1	PD	PreDelay	ms	0.0	200.0 ms	Controls the amount of time before the reverb is heard following the source signal.
2*	DCY	Decay	s	0.2 s	4.9 s	Controls the amount of time it takes for the reverb to dissipate.
3	SIZ	Size	--	2.0	200.0	Controls the perceived size of the space being created by the reverb.
4*	DMP	Damping	Hz	1000 Hz	20000 Hz	Adjusts the decay of the high frequencies within the reverb tail.
5	DIF	Diffusion	--	1.0	30.0	Controls the initial reflection density.
6*	MIX	Mix	%	0.0%	100%	Controls the mix (or ratio) of wet (processed) and dry (unprocessed) signals.
7*	LC	LoCut	Hz	10.0 Hz	500.0 Hz	Allows the low frequencies affected by the reverb to be reduced.
8*	HC	Hi Cut	Hz	200.0 Hz	20000.0 Hz	Allows the high frequencies affected by the reverb to be reduced.
9*	LFX	BassMult	--	0.5	2.0	Controls the low frequency build-up.
10	SPR	Spread	--	0.0	50.0	Emphasizes the stereo effect of the reverb.
11*	SHP	Shape	--	0.0	250.0	Adjusts the contour of the reverberation envelope.
12	MOD	ModSpeed	--	0.0	100.0	Controls the reverb tail modulation rate.

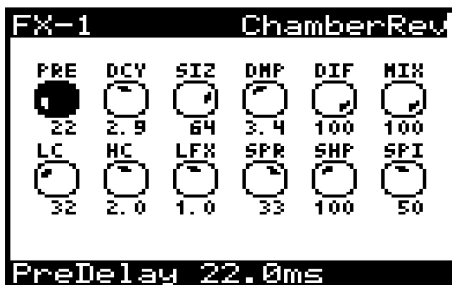
**ChamberRev (CHAMBER REVERB)**

No	DM12 REF	PARAMETER	UNITS	MIN	MAX	DESCRIPTION
1	PRE	PreDelay	ms	0.0	200.0 ms	Controls the amount of time before the reverb is heard following the source signal.
2*	DCY	Decay	s	0.3 s	28.9 s	Controls the amount of time it takes for the reverb to dissipate.
3	SIZ	Size	m	4.0 m	76.0 m	Controls the perceived size of the space being created by the reverb.
4*	DMP	Damping	Hz	1000 Hz	20000 Hz	Adjusts the decay of the high frequencies within the reverb tail.
5	DIF	Diffusion	%	0.0%	100%	Controls the initial reflection density.
6*	MIX	Mix	%	0.0%	100%	Controls the mix (or ratio) of wet (processed) and dry (unprocessed) signals.
7*	LC	LoCut	Hz	10.0 Hz	500.0 Hz	Allows the low frequencies affected by the reverb to be reduced.
8*	HC	Hi Cut	Hz	200.0 Hz	20000.0 Hz	Allows the high frequencies affected by the reverb to be reduced.
9*	LFX	BassMult	--	0.2	4.0	Controls the low frequency build-up.
10	SPR	Spread	--	0.0	50.0	Emphasizes the stereo effect of the reverb.
11*	SHP	Shape	--	0.0	250.0	Adjusts the contour of the reverberation envelope.
12	SPI	Spin	%	0.0%	100%	Controls randomization / modulation effects within the reverb.

## PlateRev (PLATE REVERB)

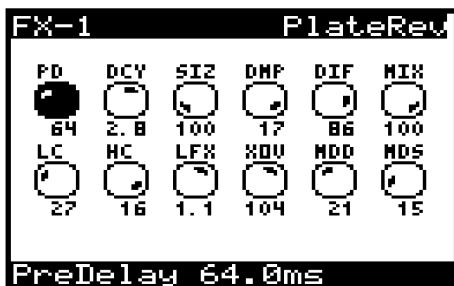

No	DM12 REF	PARAMETER	UNITS	MIN	MAX	DESCRIPTION
1	PD	PreDelay	ms	0.0	200.0 ms	Controls the amount of time before the reverb is heard following the source signal.
2*	DCY	Decay	s	0.5 s	10.0 s	Controls the amount of time it takes for the reverb to dissipate.
3	SIZ	Size	—	2.0	200.0	Controls the perceived size of the space being created by the reverb.
4*	DMP	Damping	Hz	1000 Hz	20000 Hz	Adjusts the decay of the high frequencies within the reverb tail.
5	DIF	Diffusion	—	1.0	30.0	Controls the initial reflection density.
6*	MIX	Mix	%	0.0%	100%	Controls the mix (or ratio) of wet (processed) and dry (unprocessed) signals.
7*	LC	LoCut	Hz	10.0 Hz	500.0 Hz	Allows the low frequencies affected by the reverb to be reduced.
8*	HC	Hi Cut	Hz	200.0 Hz	20000.0 Hz	Allows the high frequencies affected by the reverb to be reduced.
9*	LFX	BassMult	—	0.5	2.0	Controls the low frequency build-up.
10*	XOV	Xover	Hz	10.0 Hz	500.0 Hz	Controls the crossover point for bass multiplier.
11	MOD	ModDepth	—	1.0	50.0	Controls the reverb tail modulation depth.
12	MDS	ModSpeed	—	0.0	100.0	Controls the reverb tail modulation rate.

## RichPltRev (RICH PLATE REVERB)

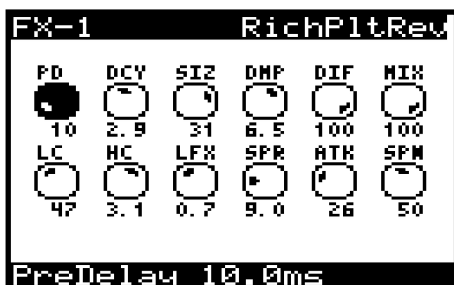

No	DM12 REF	PARAMETER	UNITS	MIN	MAX	DESCRIPTION
1	PD	PreDelay	ms	0.0	200.0 ms	Controls the amount of time before the reverb is heard following the source signal.
2*	DCY	Decay	s	0.3 s	28.9 s	Controls the amount of time it takes for the reverb to dissipate.
3	SIZ	Size	m	4.0 m	39.0 m	Controls the perceived size of the space being created by the reverb.
4*	DMP	Damping	Hz	1000 Hz	20000 Hz	Adjusts the decay of the high frequencies within the reverb tail.
5	DIF	Diffusion	%	0.0%	100%	Controls the initial reflection density.
6*	MIX	Mix	%	0.0%	100%	Controls the mix (or ratio) of wet (processed) and dry (unprocessed) signals.
7*	LC	LoCut	Hz	10.0 Hz	500.0 Hz	Allows the low frequencies affected by the reverb to be reduced.
8*	HC	Hi Cut	Hz	200.0 Hz	20000.0 Hz	Allows the high frequencies affected by the reverb to be reduced.
9*	LFX	BassMult	—	0.2	4.0	Controls the low frequency build-up.
10	SPR	Spread	—	0.0	50.0	Emphasizes the stereo effect of the reverb.
11*	ATK	Attack	—	0.0	100.0	Adjusts the contour of the reverberation envelope.
12*	SPN	Spin	%	0.0%	100%	Controls randomization / modulation effects within the reverb.

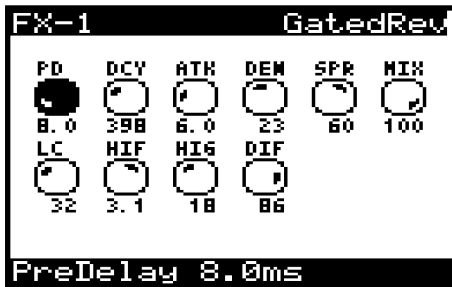

**GatedRev (GATED REVERB)**

No	DM12 REF	PARAMETER	UNITS	MIN	MAX	DESCRIPTION
1	PD	PreDelay	ms	0.0	200.0 ms	Controls the amount of time before the reverb is heard following the source signal.
2	DCY	Decay	ms	140.0 ms	1000.0 ms	Controls the amount of time it takes for the reverb to dissipate.
3*	ATK	Attack	—	0.0	30.0	Adjusts the contour of the reverberation envelope.
4*	DEN	Density	—	1.0	50.0	Manipulates the reflection density in the simulated room.
5	SPR	Spread	—	0.0	100.0	Emphasizes the stereo effect of the reverb.
6*	MIX	Mix	%	0.0%	100%	Controls the mix (or ratio) of wet (processed) and dry (unprocessed) signals.
7*	LC	LoCut	Hz	10.0 Hz	500.0 Hz	Allows the low frequencies affected by the reverb to be reduced.
8*	HIF	HiSvFreq	Hz	200.0 Hz	20000.0 Hz	Adjusts the frequency of a Hi-Shelving filter at the input of the reverb effect.
9*	HIG	HiSvGain	dB	-30.0 dB	0.0 dB	Adjusts the gain of a Hi-Shelving filter at the input of the reverb effect.
10	DIF	Diffusion	%	0.0%	100%	Controls the initial reflection density.

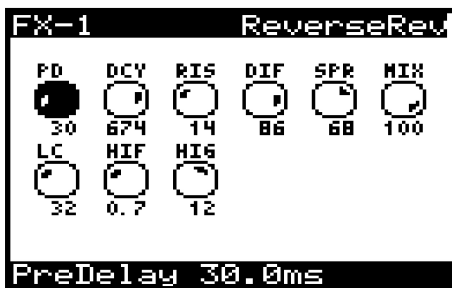
**Reverse (REVERSE REVERB)**

No	DM12 REF	PARAMETER	UNITS	MIN	MAX	DESCRIPTION
1	PD	PreDelay	ms	0.0	200.0 ms	Controls the amount of time before the reverb is heard following the source signal.
2	DCY	Decay	ms	140.0 ms	1000.0 ms	Controls the amount of time it takes for the reverb to dissipate.
3*	RIS	Rise	—	0.0	50.0	Controls how quickly the effect builds up.
4	DIF	Diffusion	—	1.0	30.0	Controls the initial reflection density.
5	SPR	Spread	—	0.0	100.0	Controls how the reflection is distributed through the envelope of the reverb.
6*	MIX	Mix	%	0.0%	100%	Controls the mix (or ratio) of wet (processed) and dry (unprocessed) signals.
7*	LC	LoCut	Hz	10.0 Hz	500.0 Hz	Allows the low frequencies affected by the reverb to be reduced.
8*	HIF	HiSvFreq	Hz	200.0 Hz	20000.0 Hz	Adjusts the frequency of a Hi-Shelving filter at the input of the reverb effect.
9*	HIG	HiSvGain	dB	-30.0 dB	0.0 dB	Adjusts the gain of a Hi-Shelving filter at the input of the reverb effect.

## ChorusVerb (CHORUS &amp; REVERB)

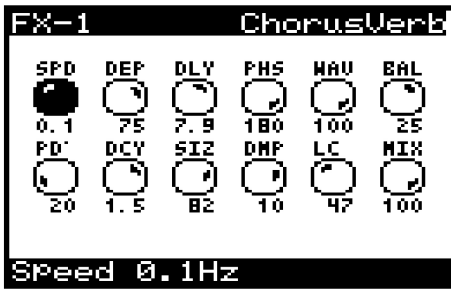

No	DM12 REF	PARAMETER	UNITS	MIN	MAX	DESCRIPTION
1*	SPD	Speed	Hz	0.0 Hz	4.0 Hz	Adjusts the rate of the chorus. Time synchronised options from 4 to 1/64 bars.
2*	DEP	Depth	%	0.0%	100%	Adjusts the modulation depth of the chorus.
3	DLY	Delay	ms	0.5 ms	50.0 ms	Adjusts the delay of the chorus.
4*	PHS	Phase	—	0.0	180.0	Offsets the phase between the left and right channels.
5	WAV	Wave	%	0.0%	100%	Adjusts the LFO waveform from a sine wave to triangular wave.
6*	BAL	Balance	—	-100.0	100.0	Adjusts the balance between chorus and reverb.
7	PRE	PreDelay	ms	0.0	200.0 ms	Controls the amount of time before the reverb is heard following the source signal.
8*	DCY	Decay	s	0.1 s	5.0 s	Controls the amount of time it takes for the reverb to dissipate.
9	SIZ	Size	—	2.0	200.0	Controls how large or small the simulated space is.
10*	DMP	Damping	Hz	1000 Hz	20000 Hz	Determines the decay of high frequencies within the reverb tail.
11*	LC	LoCut	Hz	10.0 Hz	500.0 Hz	Excludes low frequencies below the value.
12*	MIX	Mix	%	0.0%	100%	Controls the mix (or ratio) of wet (processed) and dry (unprocessed) signals.

## DelayVerb (DELAY &amp; REVERB)

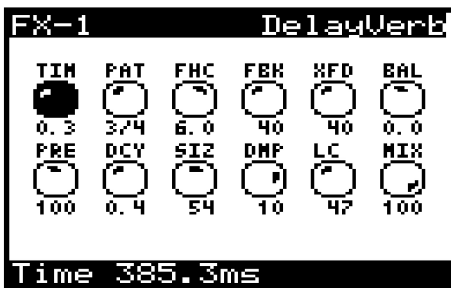

No	DM12 REF	PARAMETER	UNITS	MIN	MAX	DESCRIPTION
1	TIM	Time	ms	1.0ms	1500.0ms	Adjusts the delay time for the left channel delay. Time sync options from 4 to 1/64 bars.
2	PAT	Pattern	—	1/4	1X	Sets the delay ratio for the right channel delay.
3*	FHC	FeedHC	Hz	200.0 Hz	20000.0 Hz	Trims high frequencies from the feedback.
4*	FBK	Feedback	%	0.0%	100%	Controls the percentage of feedback.
5*	XFD	X-Feed	%	0.0%	100%	Control the amount of delay sound sent to the reverb effect.
6*	BAL	Balance	—	-100.0	100.0	Adjusts the ratio between delay and reverb.
7	PRE	PreDelay	ms	0.0	200.0 ms	Controls the amount of time before the reverb is heard following the source signal.
8*	DCY	Decay	s	0.1 s	5.0 s	Controls the amount of time it takes for the reverb to dissipate.
9	SIZ	Size	—	2.0	200.0	Controls how large or small the simulated space is.
10*	DMP	Damping	Hz	1000 Hz	20000 Hz	Determines the decay of high frequencies within the reverb tail.
11*	LC	LoCut	Hz	10.0 Hz	500.0 Hz	Excludes low frequencies below the value.
12*	MIX	Mix	%	0.0%	100%	Controls the mix (or ratio) of wet (processed) and dry (unprocessed) signals.

### FlangeVerb (FLANGER & REVERB)

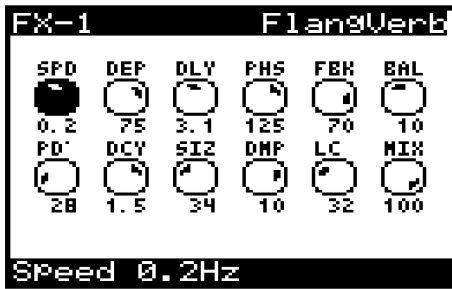

No	DM12 REF	PARAMETER	UNITS	MIN	MAX	DESCRIPTION
1*	SPD	Speed	Hz	0.0 Hz	4.0 Hz	Adjusts the rate of the flanger. Time synchronised options from 4 to 1/64 bars.
2*	DEP	Depth	%	0.0%	100%	Adjusts the modulation depth of the flanger.
3	DLY	Delay	ms	0.5 ms	20.0 ms	Adjusts the delay of the flanger.
4*	PHS	Phase	—	0.0	180.0	Offsets the phase between the left and right channels.
5*	FBK	Feed	%	-90.0%	90.0%	Controls the percentage of positive or negative feedback.
6*	BAL	Balance	—	-100.0	100.0	Adjusts the balance between flanger and reverb.
7	PRE	PreDelay	ms	0.0	200.0 ms	Controls the amount of time before the reverb is heard following the source signal.
8*	DCY	Decay	s	0.1 s	5.0 s	Controls the amount of time it takes for the reverb to dissipate.
9	SIZ	Size	—	2.0	200.0	Controls how large or small the simulated space is.
10*	DMP	Damping	Hz	1000 Hz	20000 Hz	Determines the decay of high frequencies within the reverb tail.
11*	LC	LoCut	Hz	10.0 Hz	500.0 Hz	Excludes low frequencies below the value.
12*	MIX	Mix	%	0.0%	100%	Controls the mix (or ratio) of wet (processed) and dry (unprocessed) signals.

### MidasEQ (MIDAS EQUALIZER)

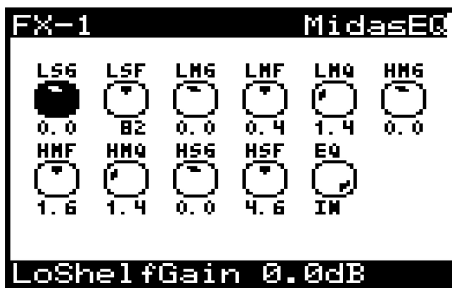

No	DM12 REF	PARAMETER	UNITS	MIN	MAX	DESCRIPTION
1	LSG*	LoShelfGain	dB	-12.0 dB	12.0 dB	Adjusts the gain of the low band.
2	LSF*	LoShelfFreq	Hz	30.0 Hz	20000.0 Hz	Adjusts the frequency of the low band.
3	LMG*	LoMidGain	dB	-12.0 dB	12.0 dB	Adjusts the gain of the low-mid band.
4	LMF*	LoMidFreq	Hz	30.0 Hz	20000.0 Hz	Adjusts the frequency of the low-mid band.
5	LMQ*	LoMidQ	—	0.3	5.0	Adjusts the Q-factor of the low-mid band.
6	HMG*	HiMidGain	dB	-12.0 dB	12.0 dB	Adjusts the gain of the high-mid band.
7	HMF*	HiMidFreq	Hz	30.0 Hz	20000.0 Hz	Adjusts the frequency of the high-mid band.
8	HMQ*	HiMidQ	—	0.3	5.0	Adjusts the Q-factor of the high-mid band.
9	HSG*	HiShelfGain	dB	-12.0 dB	12.0 dB	Adjusts the gain of the high band.
10	HSF*	HiShelfFreq	Hz	30.0 Hz	20000.0 Hz	Adjusts the frequency of the high band.
11	EQ*	EQ	—	IN	OUT	Adjusts the frequency of the high band.

## Enhancer (ENHANCING EQ)

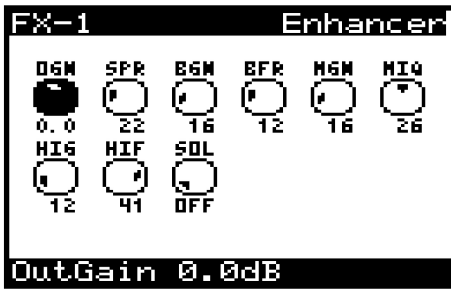

No	DM12 REF	PARAMETER	UNITS	MIN	MAX	DESCRIPTION
1*	OGN	OutGain	dB	-12.0 dB	12.0 dB	Compensates for changes in level resulting from the effect.
2*	SPR	Spread	%	0.0%	100%	Emphasizes the stereo content for a wider mix.
3*	BGN	BassGain	%	0.0%	100%	Adjusts the gain of the bass band.
4*	BFR	BassFreq	—	1.0	50.0	Adjusts the frequency of the bass band.
5*	MGN	MidGain	%	0.0%	100%	Adjusts the gain of the mid band.
6*	MIQ	MidQ	—	1.0	50.0	Adjusts the Q-factor of the mid band.
7*	HIG	HiGain	%	0.0%	100%	Adjusts the gain of the high band.
8*	HIF	HiFreq	—	1.0	50.0	Adjusts the frequency of the high band.
9	SOL	FactorC	—	OFF	ON	Solo mode - used to isolate only the audio resulting from the effect.

## FairComp (COMPRESSOR)

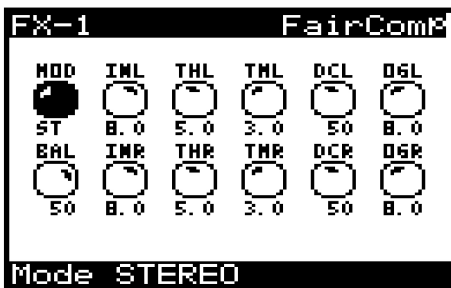

No	DM12 REF	PARAMETER	UNITS	MIN	MAX	DESCRIPTION
1	MOD	Mode	—		—	Mode of operation: Off, Stereo, Dual, M/S (Mid/Side).
2*	INL	InGain L/M	—	-20.0	0.0	Controls the input gain for the Left/Mid signal.
3*	THL	ThreshL/M	—	0.0	10.0	Controls the threshold for the Left/Mid signal.
4	TML	TimeL/M	—	1.0	6.0	Controls the attack and release time for the Left/Mid signal.
5*	DCL	DCBiasL/M	%	0.0%	100%	Adjust the ratio and knee of the compression curve for the Left/Mid signal.
6*	OGL	OutGainL/M	dB	-18.0 dB	6.0 dB	Controls the output gain for the Left/Mid signal.
7*	BAL	Bias Bal	%	-100.0%	100%	Adjust the bias current, creating accentuation of attacks
8*	INR	InGain R/S	—	-20.0	0.0	Controls the input gain for the Right/Side signal.
9*	THR	ThreshR/S	—	0.0	10.0	Controls the threshold for the Right/Side signal.
10	TMR	TimeR/S	—	1.0	6.0	Controls the attack and release time for the Right/Side signal.
11*	DCR	DCBiasR/S	%	0.0%	100%	Adjust the ratio and knee of the compression curve for the Right/Side signal.
12*	OGR	OutGainR/S	dB	-18.0 dB	6.0 dB	Controls the output gain for the Right/Side signal.

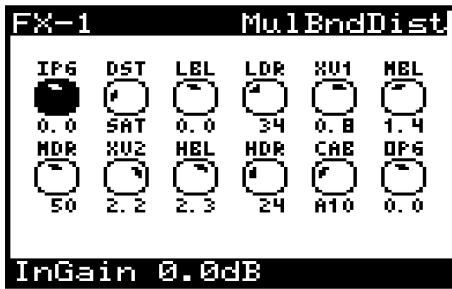
**MulBndDist (MULTIBAND DISTORTION)**

No	DM12 REF	PARAMETER	UNITS	MIN	MAX	DESCRIPTION
1*	IPG	InputGain	dB	-24.0 dB	24.0 dB	Controls the amount of input gain applied to the signal.
2	DST	Dist Types	—	—	—	Distortion Type: VAL(Valve), SAT(Saturation), TUB (Tube), & Post Filter variants (PFV/PFS/PFT).
3*	LBL	Low Level	dB	-12.0 dB	12.0 dB	Controls the level of the frequencies below XoverFreq 1.
4*	LDR	Low Drive	%	0.0%	100%	Controls the percentage of distortion introduced below XoverFreq 1.
5*	XV1	Xover Freq 1	Hz	30.0 Hz	9000.0 Hz	Sets the lower cross over frequency.
6*	MBL	Mid Level	dB	-12.0 dB	12.0 dB	Controls the level of the frequencies between Xover1 Freq and Xover2 Freq.
7*	MDR	Mid Drive	%	0.0%	100%	Controls the percentage of distortion introduced between Xover1 Freq and Xover2 Freq.
8*	XV2	Xover Freq 2	Hz	30.0 Hz	9000.0 Hz	Sets the upper cross over frequency.
9*	HBL	High Level	dB	-12.0 dB	12.0 dB	Controls the level of the frequencies below XoverFreq 2.
10*	HDR	High Drive	%	0.0%	100%	Controls the percentage of distortion introduced above XoverFreq 2.
11	CAB	Cabinet	—	—	—	Cabinet Type: OFF, VTW, VBs, A10, Mid, BFC, B60, V30, S78, Oax, A12, Rck. (See Table Above).
12*	OPG	OutputGain	dB	-12.0 dB	12.0 dB	Controls the amount of output gain applied to the signal.

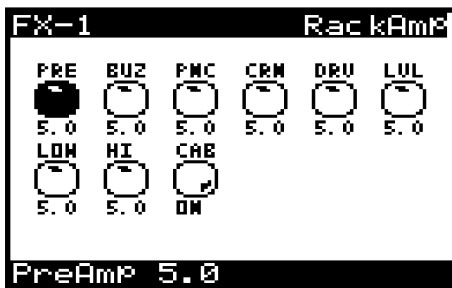
**RackAmp (RACK AMPLIFIER)**

No	DM12 REF	PARAMETER	UNITS	MIN	MAX	DESCRIPTION
1*	PRE	PreAmp	—	0.0	10.0	Adjusts the amount of input gain prior to the band-specific distortion adjustment.
2*	BUZ	Buzz	—	0.0	10.0	Adjusts the amount of low-end breakup.
3*	PNC	Punch	—	0.0	10.0	Adjusts the amount of midrange distortion.
4*	CRN	Crunch	—	0.0	10.0	Tailors the high-frequency content and distortion for smooth or cutting notes.
5*	DRV	Drive	—	0.0	10.0	Emulates the amount of power amp distortion from a tube amp.
6*	LVL	Level	—	0.0	10.0	Controls the overall output level.
7*	LOW	Low	—	0.0	10.0	EQ adjustment of the low frequencies, independent of distortion content.
8*	HI	High	—	0.0	10.0	EQ adjustment of the high frequencies, independent of distortion content.
9	CAB	Cabinet	—	OFF	ON	Turns the cabinet simulation on or off.

## EdisonEX1 (STEREO IMAGING)

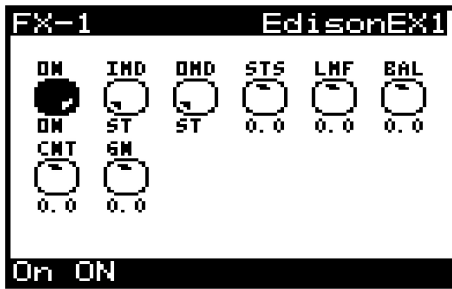

No	DM12 REF	PARAMETER	UNITS	MIN	MAX	DESCRIPTION
1	ON	On	—	OFF	ON	Allows the effect to be turned On or Off.
2	IMD	InMode	—	ST	M/S	Controls the input mode (Stereo or Mid/Side).
3	OMD	OutMode	—	ST	M/S	Controls the output mode (Stereo or Mid/Side).
4*	STS	StSpread	—	-50.0	50.0	Controls the spread of the stereo field.
5*	LMF	LMFSpread	—	-50.0	50.0	Controls the spread of the stereo field for low/mid frequencies only.
6*	BAL	Balance	—	-50.0	50.0	Adjusts the ratio of mono to stereo content.
7*	CNT	CntrDist	—	-50.0	50.0	Allows the mono content to be panned.
8*	GN	Gain	dB	-12.0 dB	12.0 dB	Controls the amount of output gain applied to the signal.

## Auto Pan (AUTO PANNING)

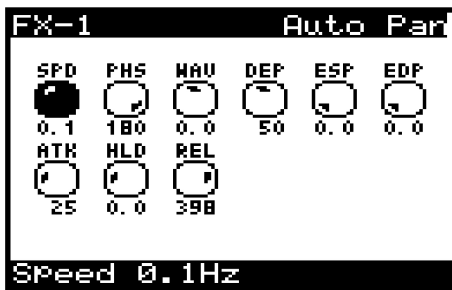

No	DM12 REF	PARAMETER	UNITS	MIN	MAX	DESCRIPTION
1*	SPD	Speed	Hz	0.0 Hz	5.0 Hz	Adjusts the LFO rate. Time synchronised options from 4 to 1/64 bars.
2*	PHS	Phase	—	0.0	180.0	Controls the LFO phase difference between the left and right channels.
3*	WAV	Wave	—	-50.0	50.0	Blends the LFO waveform between triangular and square shape.
4*	DEP	Depth	%	0.0%	100%	Controls the depth (amount) of modulation.
5*	ESP	EnvSpd	%	0.0%	100%	Adjusts how much the LFO speed is modulated by the envelope.
6*	EDP	EnvDepth	%	0.0%	100%	Adjusts the depth of the envelope modulation.
7*	ATK	Attack	ms	10.0 ms	1000.0 ms	Controls the envelope attack stage time.
8*	HLD	Hold	ms	1.0 ms	2000.0 ms	Controls the envelope hold stage time.
9*	REL	Release	ms	10.0 ms	1000.0 ms	Controls the envelope release stage time.

## NoiseGate (NOISE GATE)

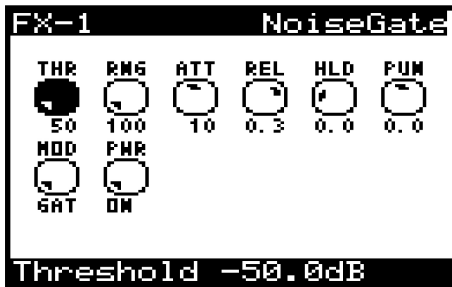

No	DM12 REF	PARAMETER	UNITS	MIN	MAX	DESCRIPTION
1*	THR	Threshold	dB	-50.0	0.0	Sets signal level at which gate opens.
2	RNG	Range	dB	-100.0	0.0	Control adjusts the amount of gain reduction applied to the signal below threshold.
3*	ATT	Attack	ms	0.0	20.0	Adjusts time taken for gate to open after an over-threshold signal.
4*	REL	Release	ms	2.0	1999.9	Adjusts time taken for gate to close after programme material falls back below threshold.
5*	HLD	Hold	ms	2.0	1999.9	This defines a waiting period before the gate starts to close.
6	PUN	Punch	—	-6.0	6.0	Used to increase tonal shaping or reduce gated breathing/delay/resonant howl-round.
7	MOD	Mode	—	—	—	GAT (Gate), TRN (Transient Gate), DUC (Ducker).
8	PWR	Power	—	ON	OFF	Enables gate in the signal path. When switched off, gate is bypassed.

## Delay (STEREO DELAY)

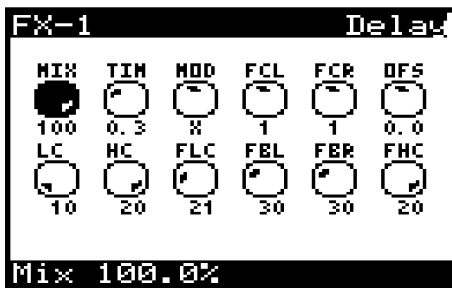

No	DM12 REF	PARAMETER	UNITS	MIN	MAX	DESCRIPTION
1*	MIX	Mix	%	0.0%	100%	Controls the mix (or ratio) of wet (processed) and dry (unprocessed) signals.
2	TIM	Time	ms	1.0 ms	1500.0 ms	Adjusts the master delay time. Time synchronised options from 4 to 1/64 bars.
3	MOD	Mode	—	—	—	S- Stereo feedback, X - crosses feedback between channels, M - Mono mix in feedback chain.
4	FCL	FactorL	—	—	—	Sets left delay to rhythmic fractions of the master delay (1/4, 3/8, 1/2, 2/3, 1, 4/3, 3/2, 2, 3).
5	FCR	FactorR	—	—	—	Sets right delay to rhythmic fractions of the master delay (1/4, 3/8, 1/2, 2/3, 1, 4/3, 3/2, 2, 3).
6	OFS	Offset	ms	-100.0 ms	100.0 ms	Adds a delay difference between the left and right delayed signals.
7*	LC	LC	Hz	10.0 Hz	500.0 Hz	Adjusts the low frequency cut, allowing lower frequencies to remain unaffected by the delay.
8*	HC	HC	Hz	200.0 Hz	20000.0 Hz	Adjusts the high frequency cut, allowing higher frequencies to remain unaffected by the delay.
9*	FLC	FeedLC	Hz	10.0 Hz	500.0 Hz	Adjusts the low cut filter frequency in the feedback paths.
10*	FBL	FeedL	%	0.0%	100%	Control the amount of feedback for the left channel.
11*	FBR	FeedR	%	0.0%	100%	Control the amount of feedback for the right channel.
12*	FHC	FeedHC	Hz	200.0 Hz	20000.0 Hz	Adjusts the high cut filter frequency in the feedback paths.

## 3TapDelay (3-TAP DELAY)

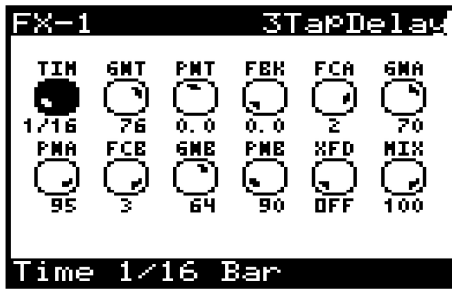

No	DM12 REF	PARAMETER	UNITS	MIN	MAX	DESCRIPTION
1	TIM	Time	ms	1.0 ms	1500.0 ms	Sets the master delay time, and the first stage. Time synchronised options from 4 to 1/64 bars.
2*	GNT	GainT	%	0.0%	100%	Sets the gain level of the first stage of the delay.
3*	PNT	PanT	%	-100%	100%	Sets the position of the first delay stage in the stereo field.
4*	FBK	Feedback	%	0.0%	100%	Adjusts the amount of feedback.
5	FCA	FactorA	—	—	—	Controls the delay time in the second stage of the delay (1/4, 3/8, 1/2, 2/3, 1, 4/3, 3/2, 2, 3).
6*	GNA	GainA	%	0.0%	100%	Controls the gain level of the second delay stage.
7*	PNA	PanA	%	-100%	100%	Sets the position of the second delay stage in the stereo field.
8	FCB	FactorB	—	—	—	Controls the delay time in the third stage of the delay (1/4, 3/8, 1/2, 2/3, 1, 4/3, 3/2, 2, 3).
9*	GNB	GainB	%	0.0%	100%	Controls the gain level of the third delay stage.
10*	PNB	PanB	%	-100%	100%	Sets the position of the third gain stage in the stereo field.
11	XFD	X-Feed	—	OFF	ON	Turns the stereo cross-feedback of the delays On or Off.
12	MIX	Mix	%	0.0%	100%	Controls the mix (or ratio) of wet (processed) and dry (unprocessed) signals.

## 4TapDelay (4-TAP DELAY)

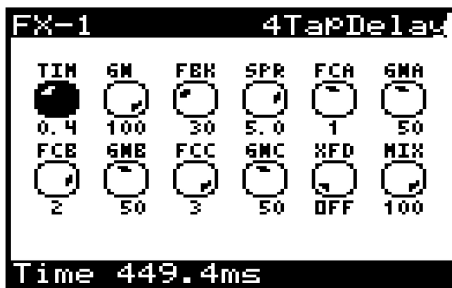

No	DM12 REF	PARAMETER	UNITS	MIN	MAX	DESCRIPTION
1	TIM	Time	ms	1.0 ms	1500.0 ms	Sets the master delay time, and the first stage. Time synchronised options from 4 to 1/64 bars.
2*	GN	Gain	%	0.0%	100%	Sets the gain level of the first stage of the delay.
3*	FBK	Feedback	%	0.0%	100%	Adjusts the amount of feedback.
4	SPR	Spread	—	0.0	6.0	Positions the first delay stage in the stereo field.
5	FCA	FactorA	—	—	—	Controls the delay time in the second stage of the delay (1/4, 3/8, 1/2, 2/3, 1, 4/3, 3/2, 2, 3).
6*	GNA	GainA	%	0.0%	100%	Controls the gain level of the second delay stage.
7	FCB	FactorB	—	—	—	Controls the delay time in the third stage of the delay (1/4, 3/8, 1/2, 2/3, 1, 4/3, 3/2, 2, 3).
8*	GNB	GainB	%	0.0%	100%	Controls the gain level of the third delay stage.
9	FCC	FactorC	—	—	—	Controls the delay time in the fourth stage of the delay (1/4, 3/8, 1/2, 2/3, 1, 4/3, 3/2, 2, 3).
10*	GNC	GainC	%	0.0%	100%	Controls the gain level of the fourth delay stage.
11	XFD	X-Feed	—	0.0	1.0	Turns the stereo cross-feedback of the delays On or Off.
12*	MIX	Mix	%	0.0%	100%	Controls the mix (or ratio) of wet (processed) and dry (unprocessed) signals.

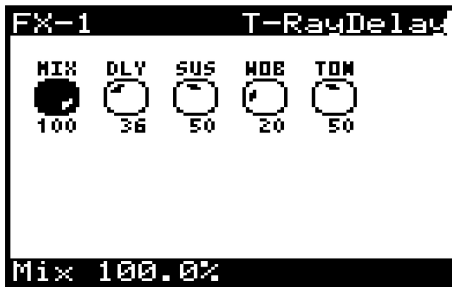

**T-RayDelay (TEL-RAY DELAY)**

No	DM12 REF	PARAMETER	UNITS	MIN	MAX	DESCRIPTION
1*	MIX	Mix	%	0.0%	100%	Controls the mix (or ratio) of wet (processed) and dry (unprocessed) signals.
2*	DLY	Delay	%	0.0%	100%	Adjusts the master delay time.
3*	SUS	Sustain	%	0.0%	100%	Controls how long the delay is sustained for. Warning at 100% build up will occur.
4*	WOB	Wobble	%	0.0%	100%	Adjusts the amount of wobble caused by age and quality of build/materials.
5*	TON	Tone	%	0.0%	100%	Controls the tone of the delays.

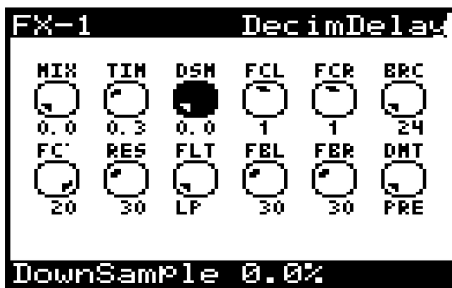
**DecimDelay (Decimator Delay)**

No	DM12 REF	PARAMETERS	UNITS	MIN	MAX	DESCRIPTION
1	MIX	Mix	%	0.00%	100.00%	Controls the mix (or ratio) of wet (processed) and dry (unprocessed) signals.
2	TIM	Time	Ms	1.0 ms	1500.0 ms	Adjusts the master delay time. Time synchronized options from 4 to 1/64 bars.
3	DSM	Downsample	%	0.00%	100.00%	Decimates the signal by reducing the sampling frequency.
4	FCL	FactorL	—	—	—	Sets left delay to rhythmic fractions of the master delay (1/4, 3/8, 1/2, 2/3, 1, 4/3, 3/2, 2, 3).
5	FCR	FactorR	—	—	—	Sets right delay to rhythmic fractions of the master delay (1/4, 3/8, 1/2, 2/3, 1, 4/3, 3/2, 2, 3).
6	BRC	Bit-Reduce	—	24	1	Decimates the signal by reducing the bit-depth.
7	FC	Cutoff	Hz	30.0 Hz	20000.0 Hz	Adjust the cutoff frequency of the filter, allowing specific frequencies to be affected by the delay.
8	RES	Resonance	%	0.00%	100.00%	Adjusts the resonance of the filter.
9	FLT	Type	—	—	—	It sets the filter type (Lowpass, Highpass, Bandpass, Notch).
10	FBL	FeedL	%	0.00%	100.00%	Controls the amount of feedback for the left channel.
11	FBR	FeedR	%	0.00%	100.00%	Controls the amount of feedback for the right channel.
12	DMT	Decimate	—	—	—	It sets the decimation on the input signal (PRE) or only on the delay (POST).

## ModDlyRev (MODULATION/DELAY/REVERB)

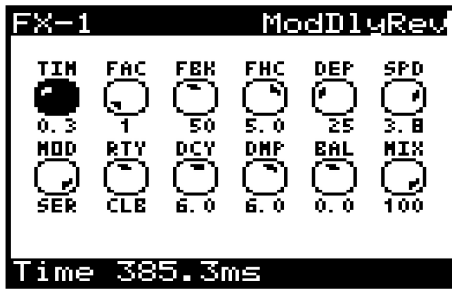

No	DM12 REF	PARAMETER	UNITS	MIN	MAX	DESCRIPTION
1	TIM	Time	ms	1.0 ms	1500.0 ms	Sets the master delay time. Time synchronised options from 4 to 1/64 bars.
2	FAC	Factor	—	—	—	Sets the delay to rhythmic fractions (1, 1/2, 2/3, 3/2).
3*	FBK	Feedback	%	0.0%	100%	Controls the percentage of positive feedback.
4*	FHC	FeedHC	Hz	200.0 Hz	20000.0 Hz	Adjusts the high cut filter frequency in the feedback path.
5*	DEP	Depth	%	0.0%	100%	Controls the depth (amount) of modulation.
6*	SPD	Speed	Hz	0.0 Hz	10.0 Hz	Adjusts the rate of the modulation. Time synchronised options from 4 to 1/64 bars.
7	MOD	Mode	—	PAR	SER	Controls the processor chain routing (Serial/Parallel)
8	RTY	Rtype	—	—	—	Reverb Type can be set to AMB (Ambience), CLUB, or HALL.
9*	DCY	Decay	—	1.0	10.0	Controls the amount of time it takes for the reverb to dissipate.
10*	DMP	Damping	—	1000 Hz	20000 Hz	Determines the decay of high frequencies within the reverb tail.
11*	BAL	Balance	—	-100.0	100.0	Adjusts ratio of the delay signal to the reverb signal.
12*	MIX	Mix	%	0.0%	100%	Controls the mix (or ratio) of wet (processed) and dry (unprocessed) signals

## Chorus (STEREO CHORUS)

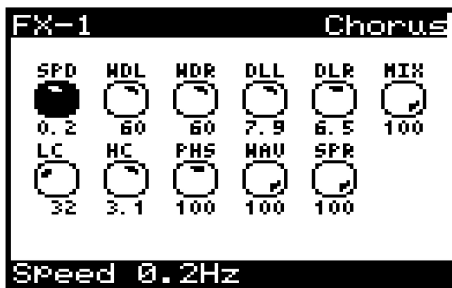

No	DM12 REF	PARAMETER	UNITS	MIN	MAX	DESCRIPTION
1*	SPD	Speed	Hz	0.0 Hz	5Hz	Sets the modulation speed. Time synchronised options from 4 to 1/64 bars.
2*	WDL	WidthL	%	0.0%	100%	Determines the amount of modulated delay in the left channel.
3*	WDR	WidthR	%	0.0%	100%	Determines the amount of modulated delay in the right channel.
4	DLL	DelayL	ms	0.5 ms	50.0 ms	Sets the total amount of delay for the left channel.
5	DLR	DelayR	ms	0.5 ms	50.0 ms	Sets the total amount of delay for the right channel.
6*	MIX	Mix	%	0.0%	100%	Controls the mix (or ratio) of wet (processed) and dry (unprocessed) signals.
7*	LC	LoCut	Hz	10.0 Hz	500.0 Hz	Allows the low frequencies in the signal to be reduced.
8*	HC	Hi Cut	Hz	200.0 Hz	20000.0 Hz	Allows the high frequencies in the signal to be reduced.
9	PHS	Phase	—	0.0	100.0	Adjusts the phase offset of the LFO between left and right channel.
10	WAV	Wave	%	0.0%	100%	Blends between the digital triangular chorus sound and the classic analog sine wave.
11*	SPR	Spread	%	0.0%	100%	Adjusts how much of the left channel is mixed into the right and vice versa.

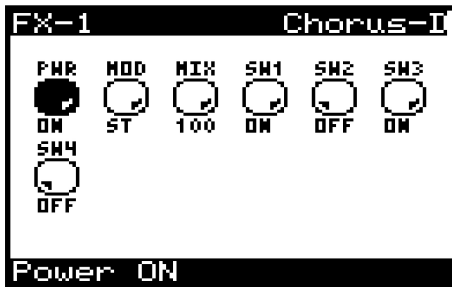
**Chorus-D (DIMENSIONAL CHORUS)**

No	DM12 REF	PARAMETER	UNITS	MIN	MAX	DESCRIPTION
1	ON	On	—	OFF	ON	Allows the effect to be turned On or Off.
2	MOD	Mode	—	M	ST	Switches the operation between Mono and Stereo modes.
3*	MIX	Mix	%	0.0%	100%	Controls the mix (or ratio) of wet (processed) and dry (unprocessed) signals.
4	SW1	Sw1	—	OFF	ON	Engages level one intensity (minimum).
5	SW2	Sw2	—	OFF	ON	Engages level two intensity.
6	SW3	Sw3	—	OFF	ON	Engages level three intensity.
7	SW4	Sw4	—	OFF	ON	Engages level four intensity (maximum).

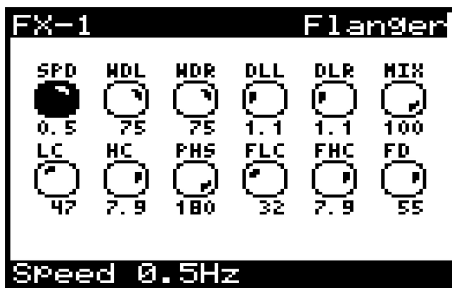
**Flanger (STEREO FLANGER)**

No	DM12 REF	PARAMETER	UNITS	MIN	MAX	DESCRIPTION
1*	SPD	Speed	Hz	0.0 Hz	5 Hz	Sets the modulation speed. Time synchronised options from 4 to 1/64 bars.
2*	WDL	WidthL	%	0.0%	100%	Determines the amount of modulated delay in the left channel.
3*	WDR	WidthR	%	0.0%	100%	Determines the amount of modulated delay in the right channel.
4	DLL	DelayL	ms	0.5 ms	20.0 ms	Sets the total amount of delay for the left channel.
5	DLR	DelayR	ms	0.5 ms	20.0 ms	Sets the total amount of delay for the right channel.
6*	MIX	Mix	%	0.0%	100%	Controls the mix (or ratio) of wet (processed) and dry (unprocessed) signals.
7*	LC	LoCut	Hz	10.0 Hz	500.0 Hz	Allows the low frequencies in the signal to be reduced.
8*	HC	Hi Cut	Hz	200.0 Hz	20000.0 Hz	Allows the high frequencies in the signal to be reduced.
9	PHS	Phase	—	0.0	180.0	Adjusts the phase offset of the LFO between left and right channel.
10*	FLC	FeedLC	Hz	10.0 Hz	500.0 Hz	Adjusts the low cut filter frequency in the feedback path.
11*	FHC	FeedHC	Hz	200.0 Hz	20000.0 Hz	Adjusts the high cut filter frequency in the feedback path.
12*	FD	Feed	%	-90.0%	90.0%	Controls the percentage of positive or negative feedback.

## Phaser (STEREO PHASER)

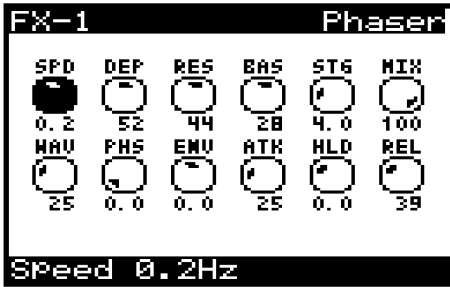

No	DM12 REF	PARAMETER	UNITS	MIN	MAX	DESCRIPTION
1*	SPD	Speed	Hz	0.0 Hz	5 Hz	Sets the modulation speed. Time synchronised options from 4 to 1/64 bars.
2*	DEP	Depth	%	0.0%	100%	Controls the depth (amount) of modulation.
3*	RES	Reso	%	0.0%	100%	Adjusts the resonance of the multiple filter stages.
4*	BAS	Base Freq	Hz	20 Hz	15000 Hz	Adjusts the frequency range of the modulated filters.
5	STG	Stages	—	2.0	12.0	Controls how many filter stages are used.
6*	MIX	Mix	%	0.0%	100%	Controls the mix (or ratio) of wet (processed) and dry (unprocessed) signals.
7	WAV	Wave	—	-50.0	+50.0	Shapes the symmetry of the LFO waveform.
8	PHS	Phase	deg	0.0	180.0	Adjusts the LFO phase difference between the left and right channel
9*	ENV	EnvMod	ms	-100.0%	100%	Adjusts the level of positive or negative envelope modulation.
10*	ATK	Attack	ms	10.0 ms	1000.0 ms	Controls the envelope attack stage time.
11*	HLD	Hold	ms	1.0 ms	2000.0 ms	Controls the envelope hold stage time.
12*	REL	Release	ms	10.0 ms	1000.0 ms	Controls the envelope release stage time.

## MoodFilter (MOOG TYPE FILTER)

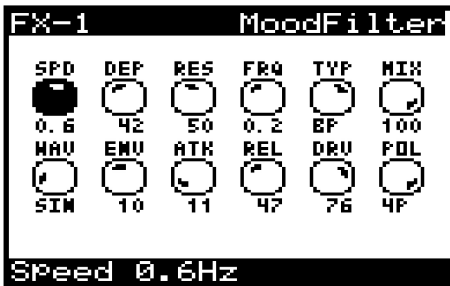

No	DM12 REF	PARAMETER	UNITS	MIN	MAX	DESCRIPTION
1	SPD	Speed	Hz	0.0 Hz	20.0 Hz	Sets the modulation speed. Time synchronised options from 4 to 1/64 bars.
2*	DEP	Depth	%	0.0%	100%	Controls the depth (amount) of modulation.
3*	RES	Resonance	%	0.0%	100%	Adjusts the resonance of the filter.
4*	FRQ	Base Freq	Hz	20 Hz	15000 Hz	Adjusts the level of positive or negative envelope modulation.
5	TYP	Type LP	—	—	—	Selects between low pass (LP), high-pass (HP), band-pass (BP) and Notch (NOT).
6*	MIX	Mix	%	0.0%	100%	Controls the mix (or ratio) of wet (processed) and dry (unprocessed) signals.
7	WAV	Wave	—	—	—	Selects modulation waveform Triangular, Sine, Saw Up, Saw Down, Ramp, Square or Random.
8*	ENV	EnvMod	%	-100.0%	100%	Adjusts the level of positive or negative envelope modulation.
9*	ATK	Attack	ms	10.0 ms	249.9 ms	Controls the filter attack time.
10*	REL	Release	ms	10.0 ms	500.0 ms	Controls the filter release time.
11*	DRV	Drive	%	0.0%	100%	Adjusts the level, also introduces an overdrive effect if pushed hard.
12	4P	4-Pole	—	2P 4P	100.0	Adjusts the slope of the filter from 2-pole to 4-pole (steeper).

## Dual Pitch (DUAL PITCH SHIFTER)

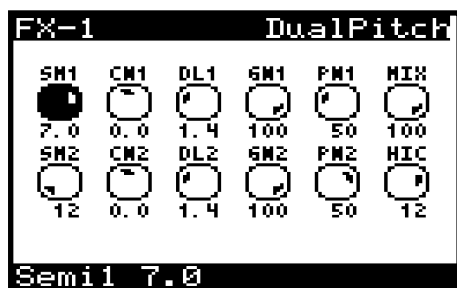

No	DM12 REF	PARAMETER	UNITS	MIN	MAX	DESCRIPTION
1*	SM1	Semi1	—	-12.0	12.0	Adjusts the pitch of the first channel in semi-tones.
2*	CN1	Cent1	—	-50.0	50.0	Adjusts the pitch of the first channel in cents.
3	DL1	Delay1	ms	1.0 ms	500.0 ms	Adjusts the time difference between the wet and dry signals. Sync options from 4 to 1/64 bars.
4*	GN1	Gain1	%	0.0%	100%	Allows gain compensation to be applied to the first channel.
5*	PN1	Pan1	%	-100.0%	100%	Allows panning of the first channel.
6*	MIX	Mix	%	0.0%	100%	Controls the mix (or ratio) of wet (processed) and dry (unprocessed) signals.
7*	SM2	Semi2	—	-12.0	12.0	Adjusts the pitch of the second channel in semi-tones.
8*	CN2	Cent2	—	-50.0	50.0	Adjusts the pitch of the second channel in cents.
9	DL2	Delay2	ms	1.0 ms	500.0 ms	Adjusts the time difference between the wet and dry signals. Sync options from 4 to 1/64 bars.
10*	GN2	Gain2	%	0.0%	100%	Allows gain compensation to be applied to the second channel.
11*	PN2	Pan2	%	-100.0%	100%	Allows panning of the second channel.
12*	HIC	HiCut	Hz	200.0 Hz	20000.0 Hz	Allows the high frequencies affected by the pitch shifting to be reduced.

## RotarySpkr (ROTARY SPEAKER)

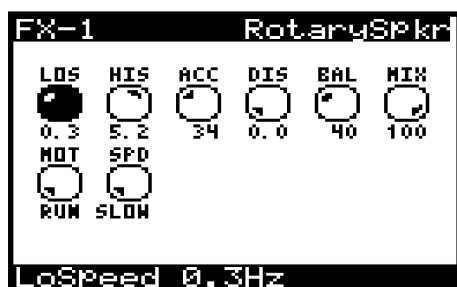

No	DM12 REF	PARAMETER	UNITS	MIN	MAX	DESCRIPTION
1*	LOS	LoSpeed	Hz	0.1 Hz	4.0 Hz	Adjusts the rotational speed when the Low Speed operation is selected.
2*	HIS	HiSpeed	Hz	2.0 Hz	9.9 Hz	Adjusts the rotational speed when the High Speed operation is selected.
3*	ACC	Accel	%	0.0%	100%	Adjusts how quickly the speed increases and decreases from the Slow mode to the Fast mode.
4*	DIS	Distance	%	0.0%	100%	Adjusts the distance between the Rotary speakers and the virtual microphone.
5*	BAL	Balance	—	-100.0	100.0	Adjusts the balance between the virtual horn and virtual drum controlling the signal tone.
6*	MIX	Mix	%	0.0%	100%	Controls the mix (or ratio) of wet (processed) and dry (unprocessed) signals.
7*	MOT	Motor	—	RUN	STOP	Allows The rotation effect of the motor to be disengaged (STOP).
8*	SPD	Speed	—	SLOW	FAST	Selects either the slow or fast speeds for rotation.

## 10. Short-cuts

In order to speed up programming tasks there are several short-cuts implemented on the DeepMind 12 as listed below.

Note: While holding down any of the shortcut switches the menu will momentarily switch to the relevant menu. Once you release the shortcut switch you will be returned to the PROG screen.

### 10.1 Menu Parameter Reset

To reset any menu parameter to its default setting momentarily press the -NO and +YES switches at the same time.

### 10.2 LFO 1 Shape

To change the LFO 1 waveform shape press and hold the LFO 1 EDIT switch. While holding the switch you can use the LFO 1 RATE fader to set the LFO 1 waveform shape. The following message will be shown to give you guidance while holding the LFO 1 EDIT switch.

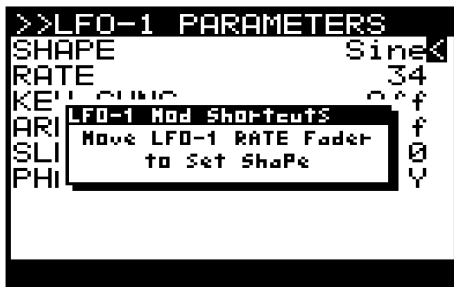

### 10.3 LFO 2 Shape

To change the LFO 2 waveform shape press and hold the LFO 2 EDIT switch. While holding the switch you can use the LFO 2 RATE fader to set the LFO 2 waveform shape. The following message will be shown to give you guidance while holding the LFO 2 EDIT switch.



## 10.4 OSC Modulation Sources

To change any of the OSC Modulation sources press and hold the OSC EDIT switch. While holding the switch you can use any of the following faders to set the source for the respective parameter:

- OSC 1 PITCH MOD
- OSC 1 PWM
- OSC 2 PITCH MOD
- OSC 2 TONE MOD

The following message will be shown to give you guidance while holding the OSC EDIT switch

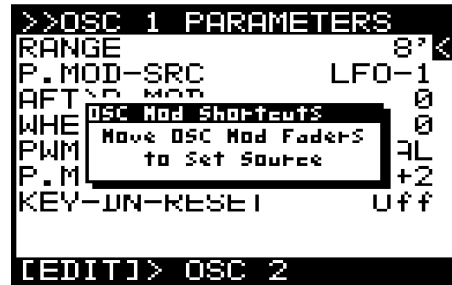

### 10.5 VCF LFO Source

To change the VCF LFO source press and hold the VCF EDIT switch. While holding the switch you can use the VCF LFO fader to select the source LFO. The following message will be shown to give you guidance while holding the LFO 1 EDIT switch.

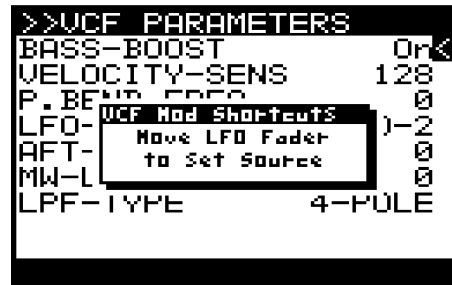

## 10.6 MOD MATRIX Bus Configuration

Each MOD MATRIX bus can be configured without having to scroll through the large lists of sources and destinations. In order to do this please use the following steps:

- 1) Use the navigation switches to select one of the parameters on the bus you would like to configure.
- 2) Press and hold the MOD switch
- 3) To select a modulation source press an edit switch (further presses will cycle through the options associated with the switch), or press any key on the keyboard to cycle through the sources associated with notes.
- 4) To select a modulation destination move the fader of the required parameter.
- 5) To set the modulation depth adjust the data entry fader.

Once you have configured the bus as you require you can release the MOD MATRIX switch.

Note: All changes will immediately have an effect so that you can hear the changes to your program by the modulation bus.

# 11. Applications

On the following pages we present the most useful applications for your DeepMind 12 analog polyphonic synthesizer, using a few practical examples.

## 11.1 Studio Configuration Example

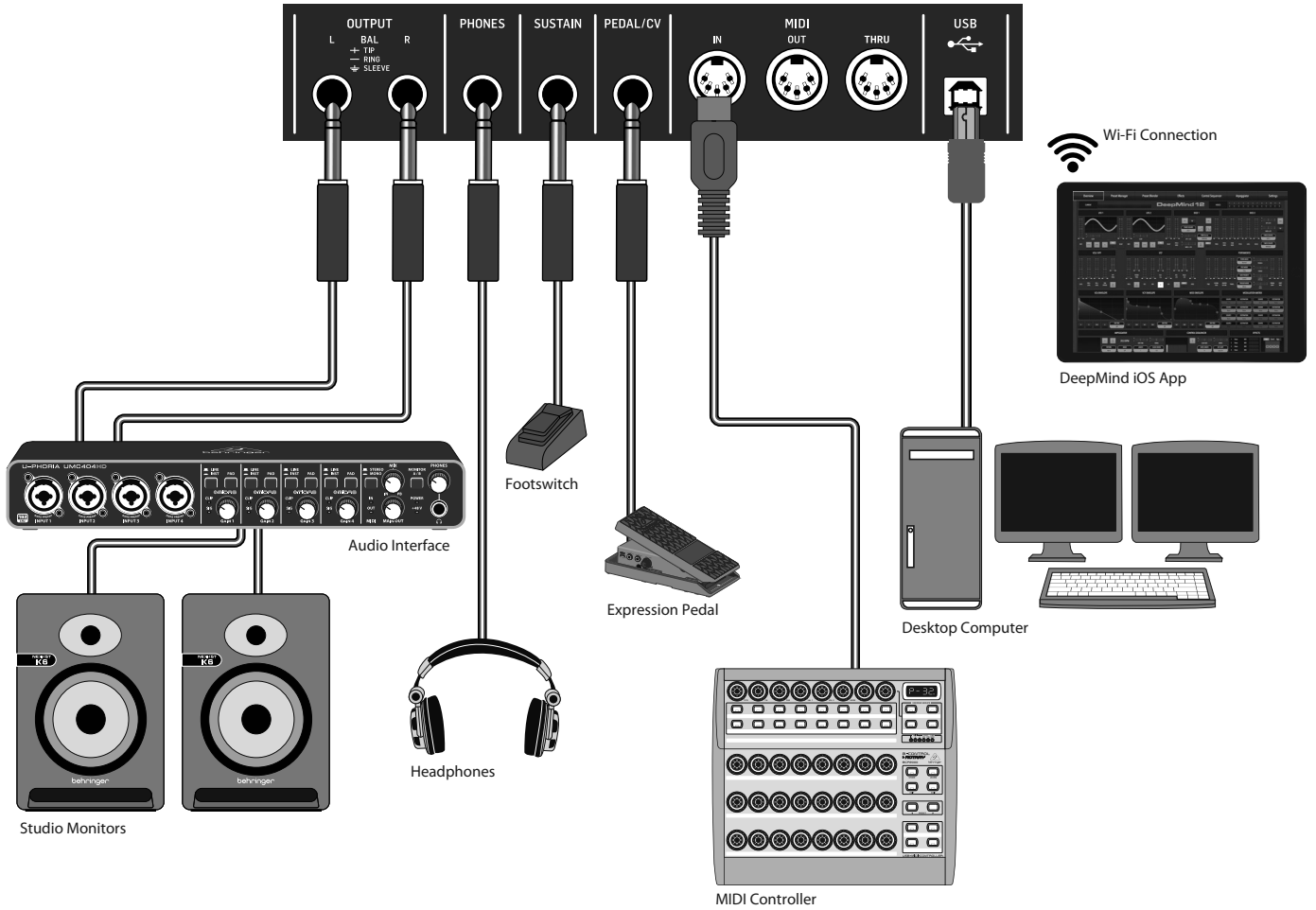

## 11.2 Live Configuration Example

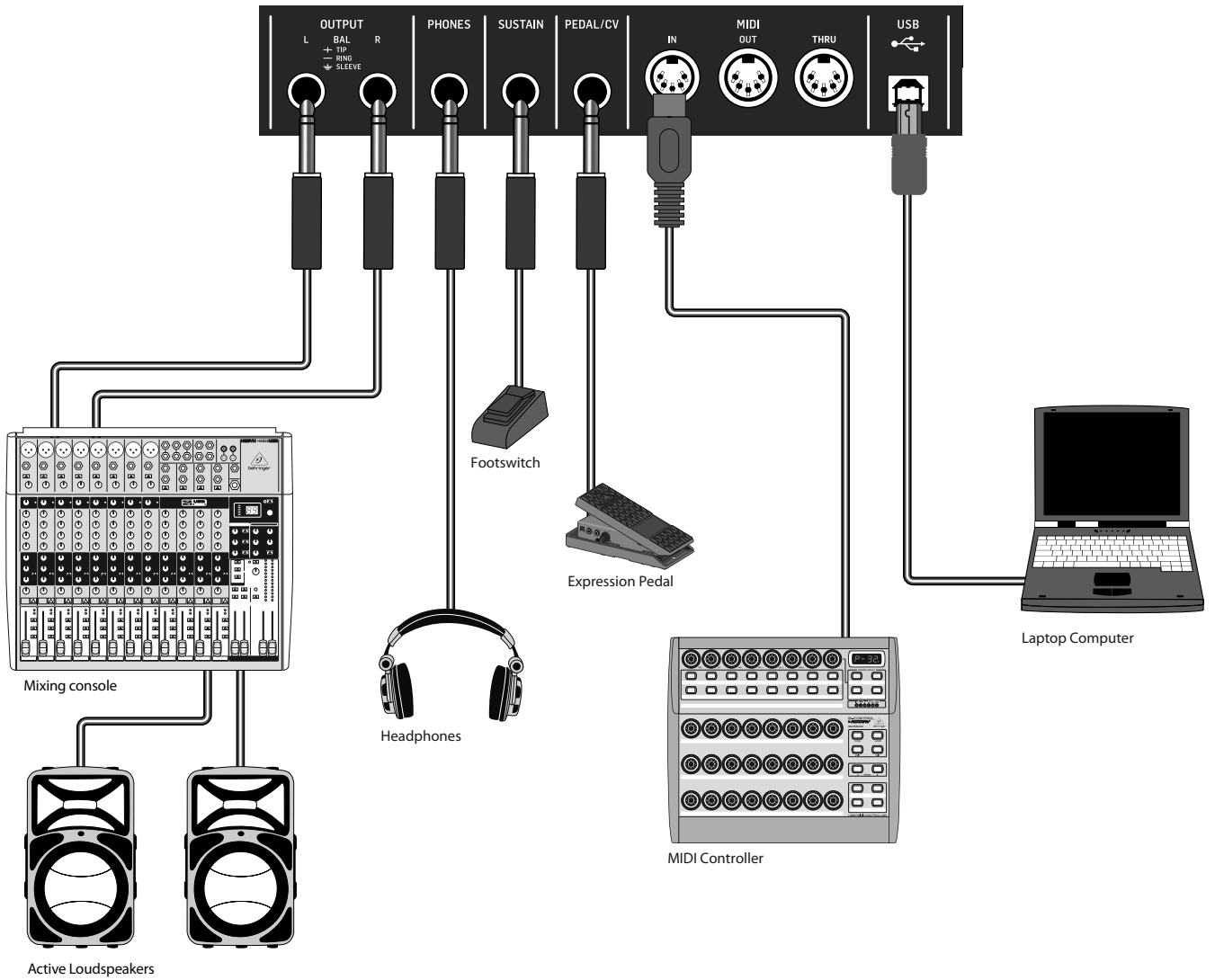



### 11.3 Band/Practice Configuration Example

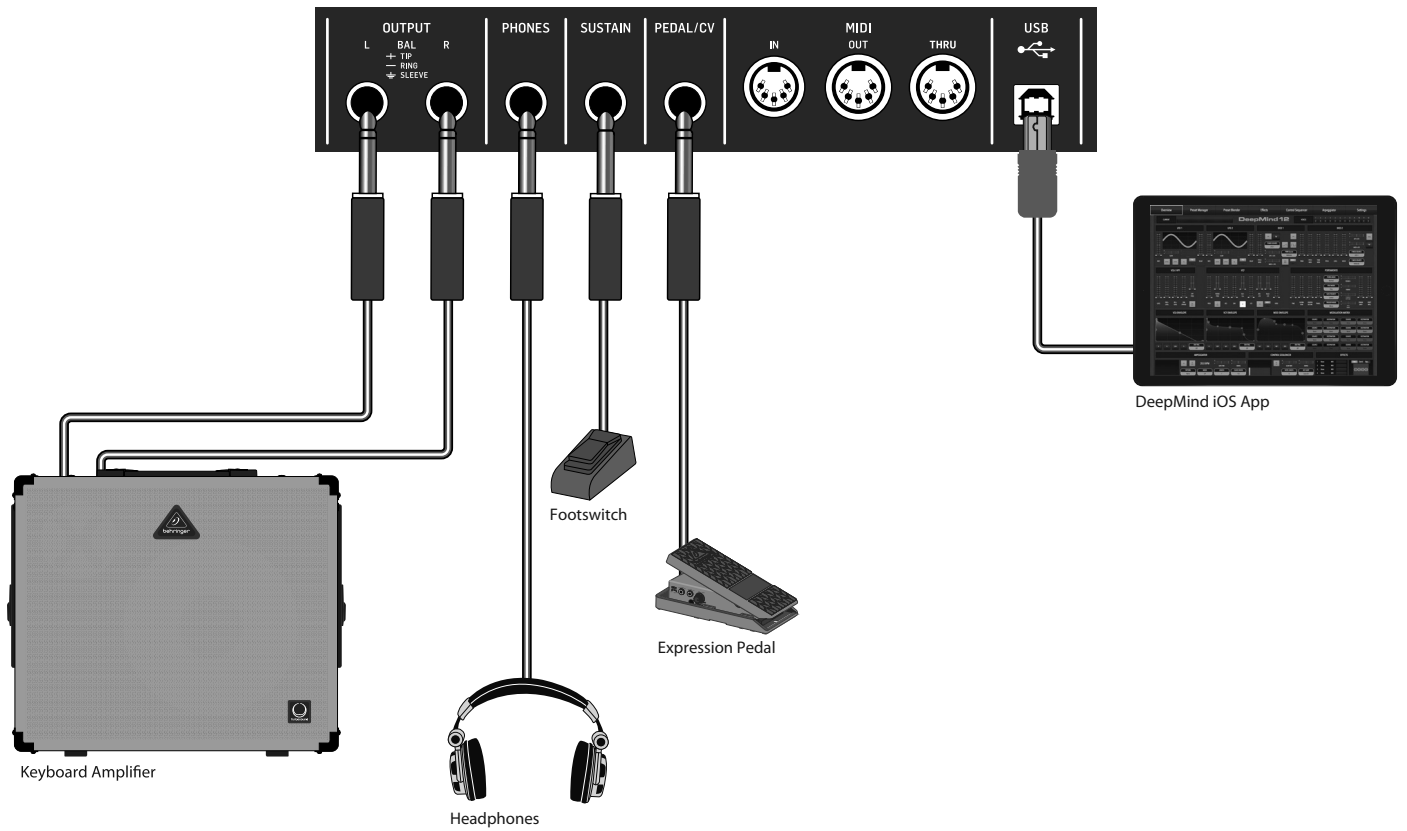

### 11.4 Interfacing with Other Hardware Example

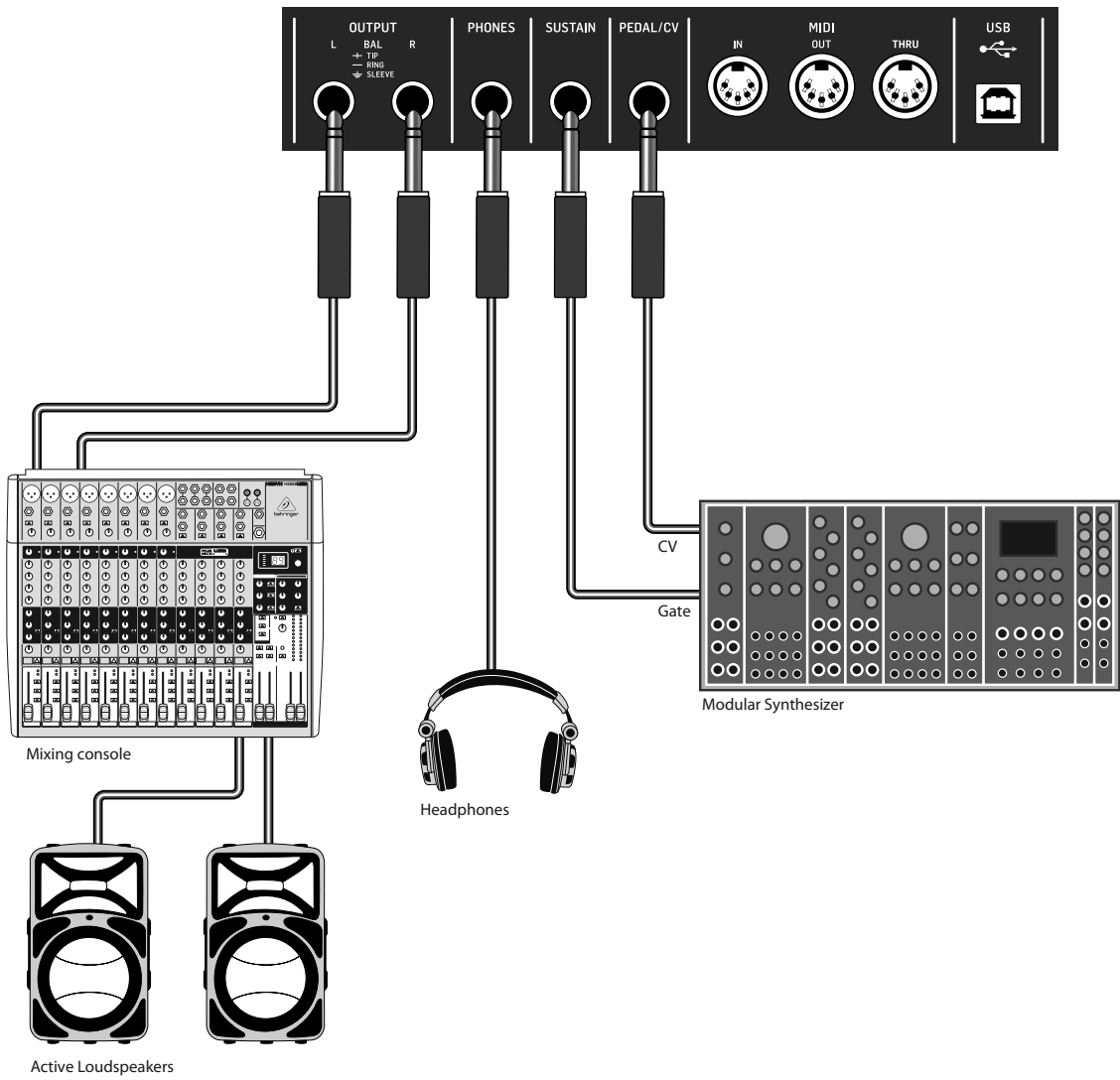

### 11.5 Interfacing with Modular Synthesizer Example

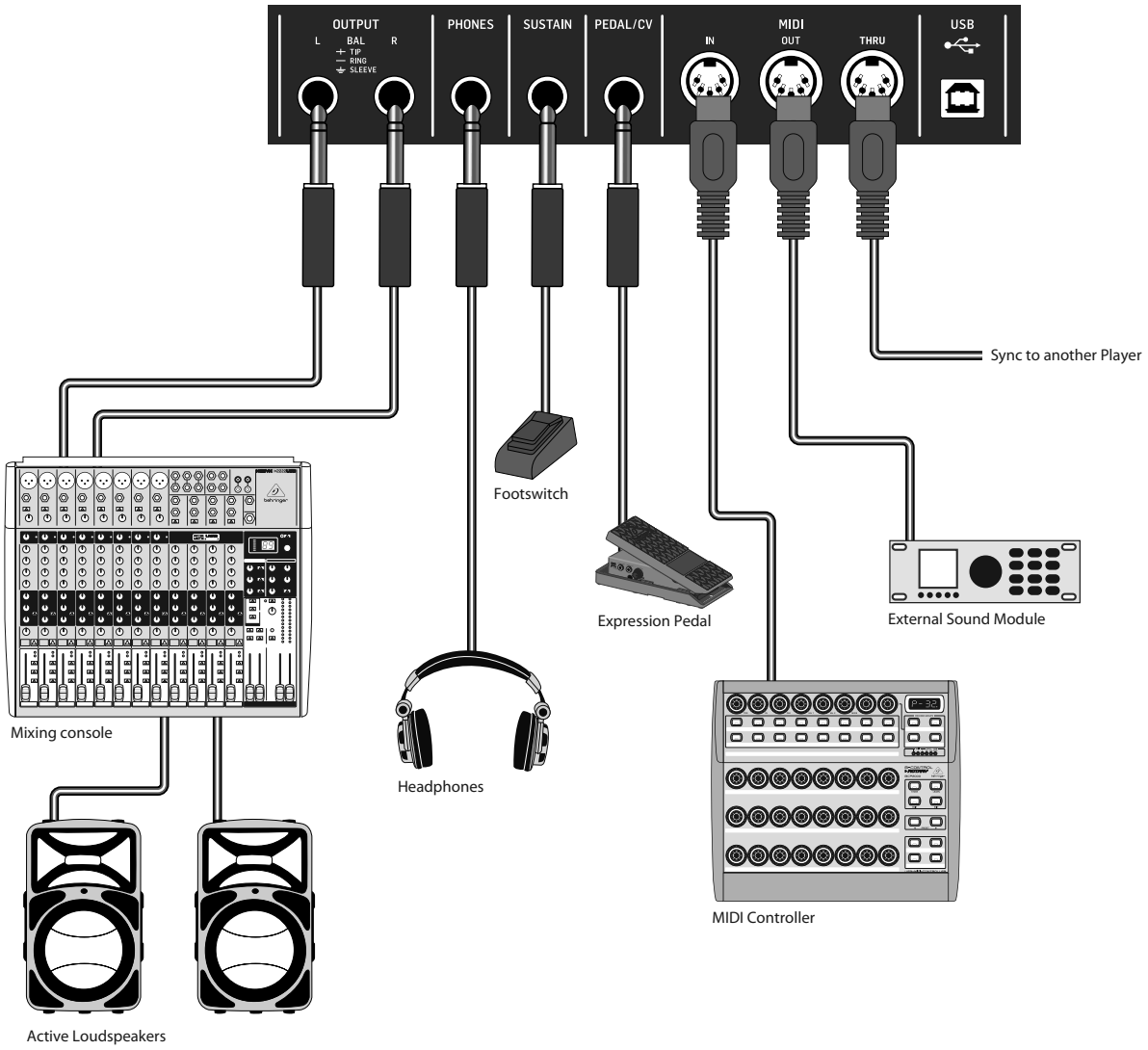

## 12. DAW MIDI Configuration

All the parameters which can be controlled by MIDI can of course be recorded and then played back as automation data within any DAW or application that supports MIDI.

The DeepMind 12 offers three methods of communicating via MIDI:

- **Physical MIDI Ports** - When using the physical MIDI ports you will need to connect these to a MIDI interface or other device which can pass the MIDI information to your host computer/tablet/phone.
- **USB-MIDI** - The DeepMind 12 is a class compliant USB device and should appear as both inputs and outputs in most applications without the need for any additional drivers.
- **WiFi-MIDI** - The DeepMind 12 supports RTP-MIDI and should appear as both inputs and outputs in most applications without the need for any additional drivers.

In order to use the DeepMind 12 analog polyphonic synthesizer in conjunction with a Digital Audio Workstation (DAW) or any Audio/MIDI application please follow these steps:

Ensure that the relevant interface (MIDI/USB/Wi-Fi) is configured correctly in the GLOBAL-CONNECTIVITY menu.

Ensure that the DeepMind 12 is an active input and output in your DAW / Application MIDI setup.

Ensure that the your DAW is setup to receive MIDI on the same channel as the DeepMind 12 Transmit channel.

Recording, editing and playback of Note data such as Note number, Velocity, Note Length etc, should be possible in most applications.

Recording, editing and playback of MIDI CC data such as Aftertouch, Pitch Bend, Mod Wheel or any of the faders should be possible in most applications.

Recording and playback of MIDI NRPN data is only possible in certain applications, please consult your manufacturers data for details on NRPN support.

**Note:** If you adjust a parameter using an external device or application connected the DeepMind 12 will forward the change to the other interfaces. E.g. a changed received over Wi-Fi will be re-transmitted by the DeepMind 12 to both the USB port and the MIDI socket. The data format will be dependant on the mode settings for each interface

**Warning:** Be careful not to create any kind of MIDI loop as feeding back the same information to the DeepMind 12 will cause erratic behavior.

# 13. System Block Diagram

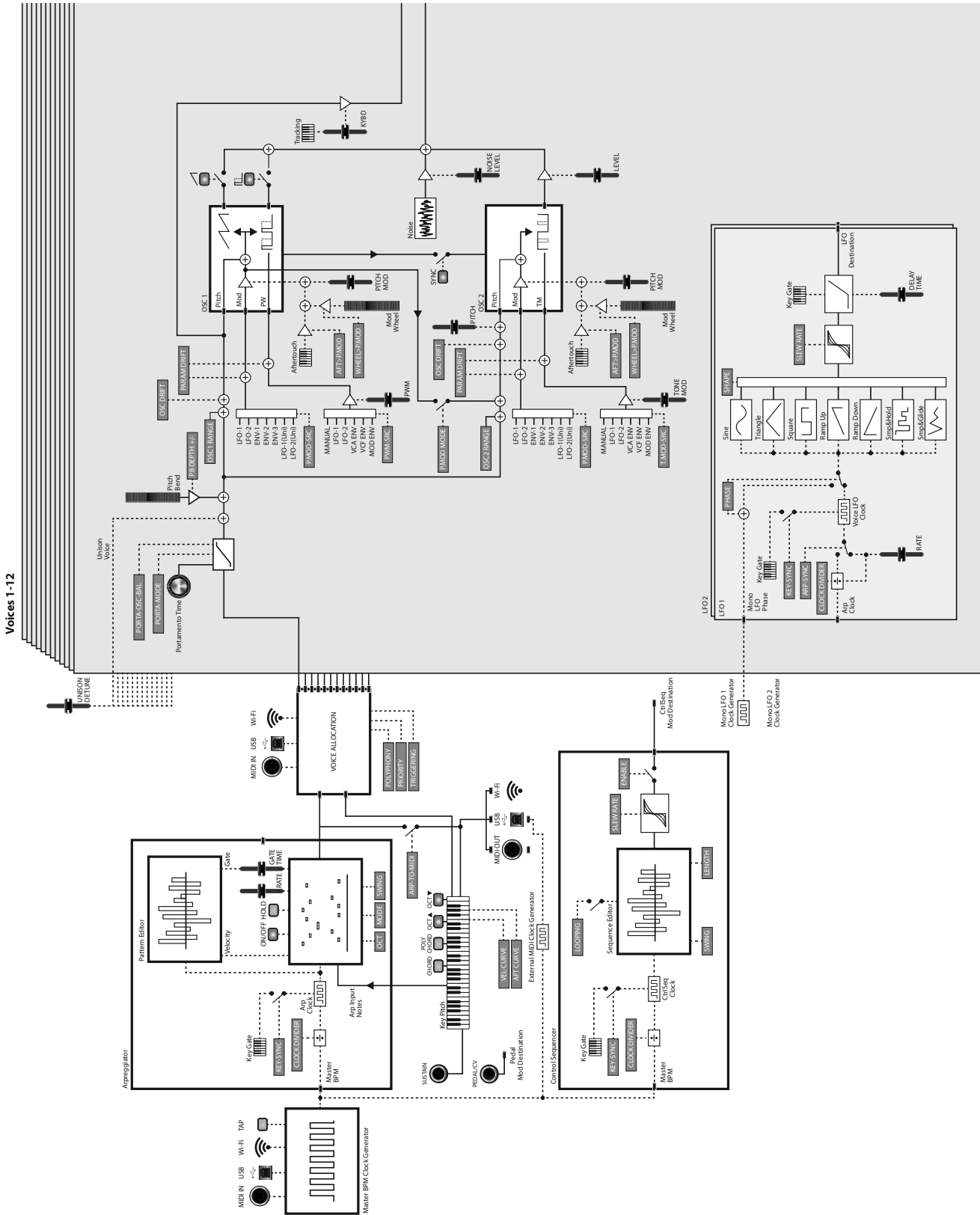

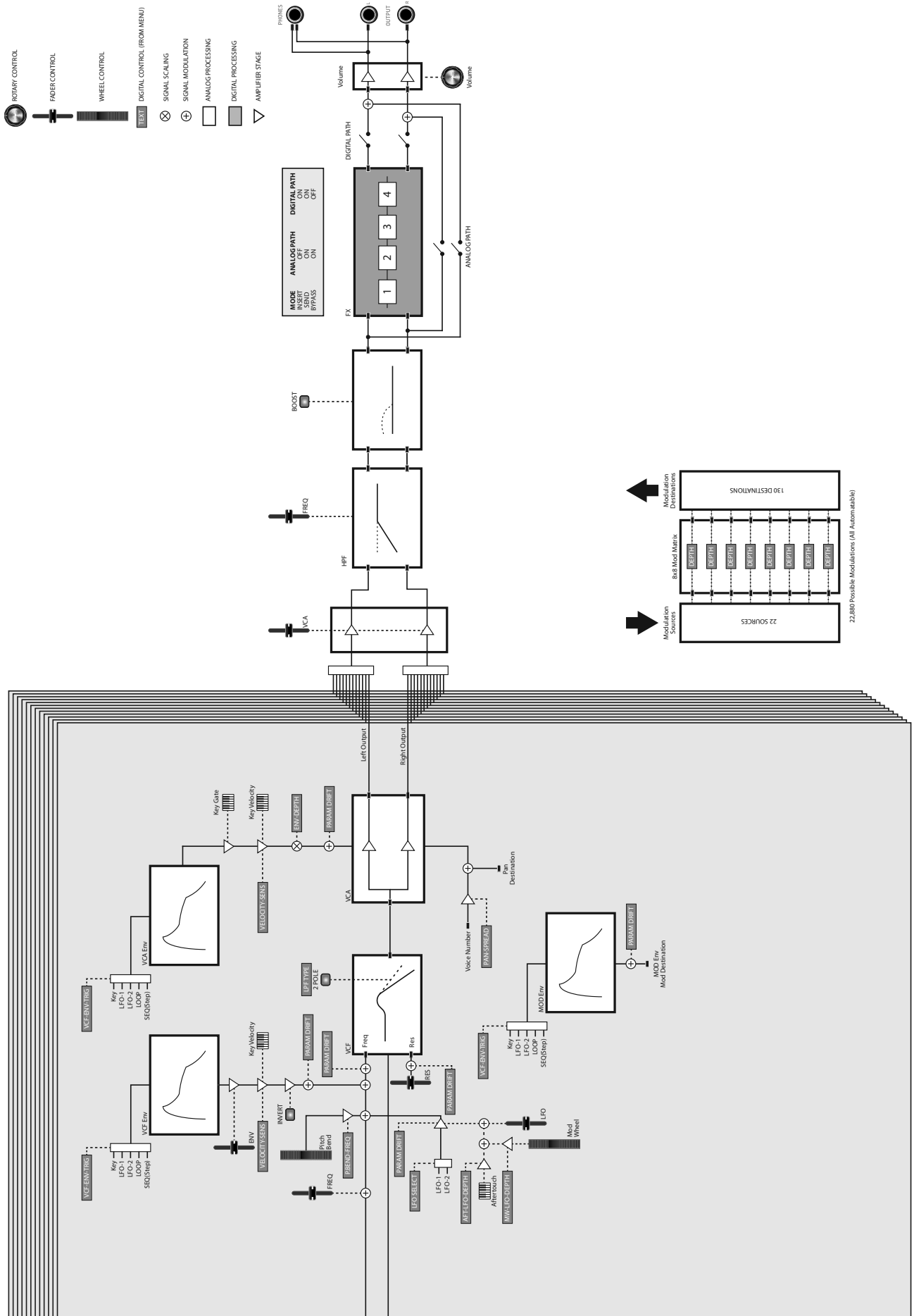

# 14. Connection Wiring Diagrams

The DeepMind 12 analog polyphonic synthesizer uses servo-balanced outputs. The circuit design has an automatic hum suppression with balanced signals and is able to operate, without problem, even at highest levels. Externally-induced mains hum etc, is thus efficiently suppressed.

The servo-function, also automatic, recognizes the connection of unbalanced pin assignments and changes the nominal level internally so that there is no difference in level between the input and output signals (6 dB correction).

⚠ Please ensure that only qualified persons install and operate the device. During installation and operation the user must have sufficient contact to earth. Electrostatic discharges might affect the operation of the unit.

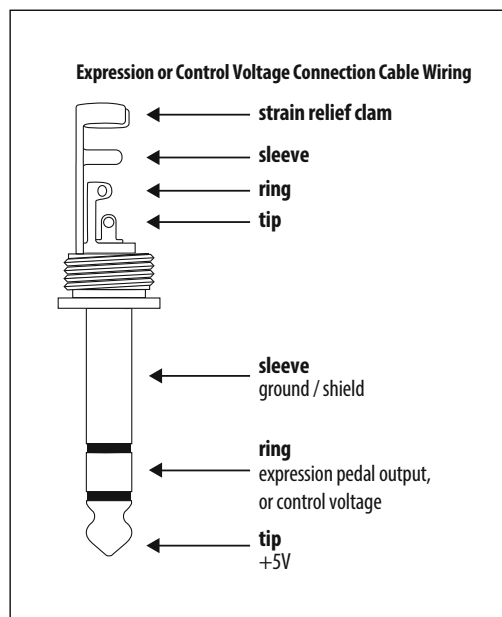
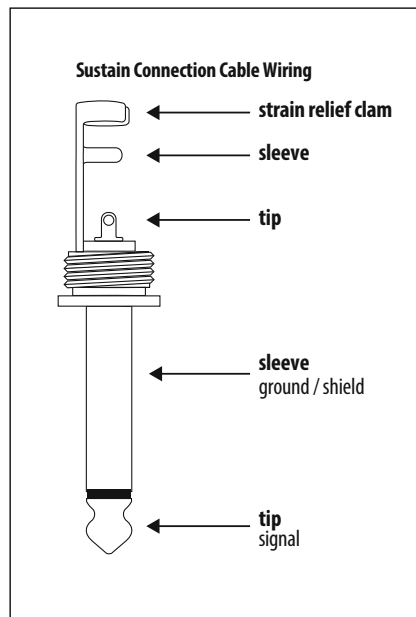
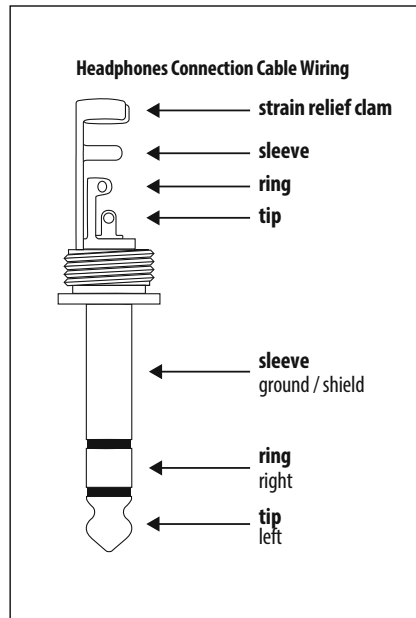
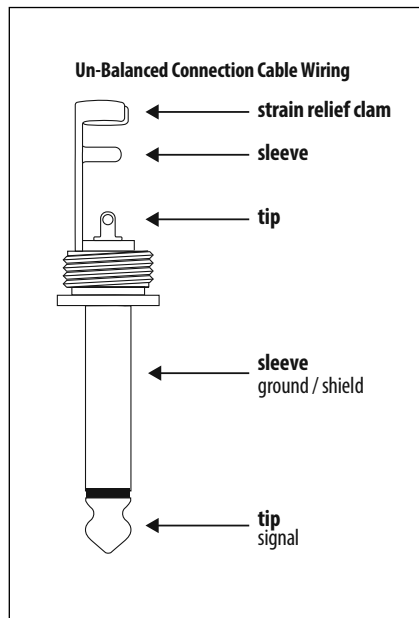
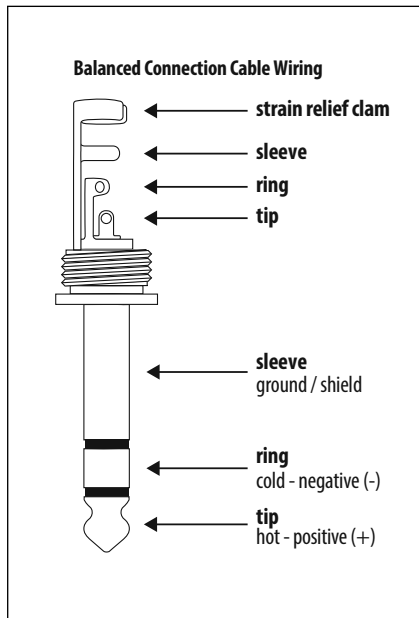

## 15. Technical Specifications

### Global

Display	Backlit LCD
Main Menus	PROG, FX, GLOBAL, COMPARE, WRITE
Edit Menus	ARP/SEQ, LFOs, OSCs, POLY, VCF, VCA, VCA ENV, VCF ENV, MOD ENV, MOD MATRIX
Presets	8 banks each with 128 programs
Fader Modes	MIDI CC, NRPN, OFF

### Controls

Keyboard	49 semi-weighted, full-size keys
Keyboard sensing	Aftertouch and note on/off velocity
Encoders	1 rotary knob
Faders	26 slide faders (35 mm)
Switches	33 backlit switches
Modulation	Free moving wheel
Pitch Bend	Spring loaded wheel

### Connectivity

MIDI In/Out/Thru	5-pin DIN / 16 channels
Pedal/CV	¼" TRS
Sustain	¼" TS
USB	USB 2.0, type B
Output L/R	¼" TRS, balanced, max. +18 dBu
Headphones	¼" TRS, unbalanced, max. +21 dBu

### Synthesizer Architecture

Number of voices	12 analog
OSC	2 per voice
LFO	2 per voice
VCF	2-pole / 4-pole
HPF (Common to all voices)	6 dB per octave
Envelopes	VCA, VCF, MOD
Mod Matrix	22 sources / 130 destinations

### Digital Effects

FX Slots	4 per Program
FX Types	34 Algorithms
Internal effects engines	1 true stereo SHARC DSP
Effects signal processing	32/40-bit floating point @ 48 kHz
A/D-D/A performance	24-bit 48 kHz, 114 dB dynamic range
Bypass	True hard bypass

### USB

Type	Class compliant USB 2.0, type B
Supported operating systems	Windows 7 or higher** Mac OS X 10.6.8 or higher iOS 8 or higher (iPad) Android 6.0 or higher

### Wi-Fi

Antenna	Internal
Access Point, number of clients	Max. 1
IEEE 802.11 b/g standard	2.4 GHz
Frequency Range	2,412 - 2,462 MHz
WLAN channels	11
Max Output Power	16 dBm (802.11 b) / 20 dBm (802.11 g) / 20 dbm (802.11 n)

### Power

Mains connector	Standard IEC receptacle
Power consumption	55 W max.
Fuse	T3.15AH250 V
Internal Switch-mode PSU	Autorange 100-240 V, (50/60 Hz)

### Environmental

Operating temperature range	5°C – 40°C (41°F – 104°F)
-----------------------------	---------------------------

### Physical (Packaged)

Dimensions (H x W x D)	103 x 822 x 257 mm (4.1 x 32.4 x 10.1")
Weight	8.4 kg (18.5 lbs)
Shipping Weight	10.5 kg (23.1 lbs)



## 16. MIDI Commands

MIDI (Musical Instrument Digital Interface) is a messaging protocol used to transfer or communicate information between devices and/or host computers.

### 16.1 MIDI Implementation Chart

#### MIDI Implementation Chart v. 2.0

Manufacturer: **Behringer** Model: **DeepMind 12** Version: **1.0** Date: **01 September 2016**

	Transmit/Export	Recognize/Import	Remarks
<b>1. Basic Information</b>			
MIDI channels	1-16	—	—
Note numbers	C0-C8	—	—
Program change	Yes	Yes	—
"Bank Select response? (Yes/No)	Yes	Yes	—
If yes, list banks utilized in remarks column"			
"Modes supported : Mode 1: Omni-On, Poly (Yes/No)	—	—	—
Mode 2: Omni-On, Mono (Yes/No) Mode 3: Omni-Off, Poly (Yes/No) Mode 4:			
Omni-Off, Mono (Yes/No) Multi Mode (Yes/No)"			
Note-On Velocity (Yes/No)	Yes	Yes	—
Note-Off Velocity (Yes/No)	Yes	Yes	—
Channel Aftertouch (Yes/No)	Yes	Yes	—
Poly (Key) Aftertouch (Yes/No)	No	No	—
Pitch Bend (Yes/No)	Yes	Yes	—
Active Sensing (Yes/No)	—	—	—
System Reset (Yes/No)	—	—	—
Tune Request (Yes/No)	—	—	—
"Universal System Exclusive: Sample Dump Standard (Yes/No)	—	—	—
Device Inquiry (Yes/No) File Dump (Yes/No) MIDI Tuning (Yes/No) Master Volume			
(Yes/No) Master Balance (Yes/No)			
Notation Information (Yes/No) Turn GM1 System On (Yes/No) Turn GM2 System			
On (Yes/No) Turn GM System Off (Yes/No) DLS-1 (Yes/No)			
File Reference (Yes/No) Controller Destination (Yes/No)			
Key-based Instrument Ctrl (Yes/No) Master Fine/Coarse Tune (Yes/No) Other			
Universal System Exclusive"			
Manufacturer or Non-Commercial System Exclusive	—	—	—
NRPNS (Yes/No)	—	—	—
"RPN 00 (Pitch Bend Sensitivity) (Yes/No) RPN 01 (Channel Fine Tune) (Yes/No)	—	—	—
RPN 02 (Channel Coarse Tune) (Yes/No) RPN 03 (Tuning Program Select) (Yes/No)			
RPN 04 (Tuning Bank Select) (Yes/No)			
RPN 05 (Modulation Depth Range) (Yes/No)"			
<b>2. MIDI Timing and Synchronization</b>			
MIDI Clock (Yes/No)	—	—	—
Song Position Pointer (Yes/No)	—	—	—
Song Select (Yes/No)	—	—	—
Start (Yes/No) Continue (Yes/No) Stop (Yes/No)	Start: Yes, Continue: Yes, Stop: Yes	—	—
MIDI Time Code (Yes/No)	—	—	—
MIDI Machine Control (Yes/No)	—	—	—
MIDI Show Control (Yes/No) If yes, MSC Level supported	—	—	—
<b>3. Extensions Compatibility</b>			
"General MIDI compatible? (Level(s)/No)	—	—	—
Is GM default power-up mode? (Level/No)"			
DLS compatible? (Levels(s)/No) (DLS File Type(s)/No)	—	—	—
Standard MIDI Files (Type(s)/No)	—	—	—
XMF Files (Type(s)/No)	—	—	—
SP-MIDI compatible? (Yes/No)	—	—	—

## 16.2 Continuous Controller Messages

### MIDI Implementation Chart v. 2.0 Control Number Information Page 1 of 3

Manufacturer: **Behringer** Model: **DeepMind 12** Version: **1.0** Date: **01 September 2016**

#### 1. Basic Information

Control #	Function	Transmitted (Y/N)	Recognized (Y/N)	Remarks
0	Bank Select (MSB)	Yes	Yes	—
1	Modulation Wheel (MSB)	Yes	Yes	—
2	Breath Controller (MSB)	Yes	Yes	—
3	—	—	-	—
4	Foot Controller (MSB)	Yes	Yes	—
5	Portamento Time (MSB)	Yes	Yes	—
6	Data Entry (MSB)	Yes	Yes	—
7	Channel Volume (MSB)	Yes	Yes	—
8	Balance (MSB)	Yes	Yes	—
9	—	—	—	—
10	Pan (MSB)	Yes	Yes	—
11	Expression (MSB)	Yes	Yes	—
12	Arpeggiator Rate	Yes	Yes	Replaces: Effect Control 1 (MSB)
13	Arpeggiator Gate Time	Yes	Yes	Replaces: Effect Control 2 (MSB)
14	—	—	—	—
15	—	—	—	—
16	LFO 1 Rate	Yes	Yes	Replaces: General Purpose Controller 1 (MSB)
17	LFO 1 Delay Time	Yes	Yes	Replaces: General Purpose Controller 2 (MSB)
18	LFO 2 Rate	Yes	Yes	Replaces: General Purpose Controller 3 (MSB)
19	LFO 2 Delay Time	Yes	Yes	Replaces: General Purpose Controller 4 (MSB)
20	OSC1 Pitch Modulation	Yes	Yes	—
21	OSC1 Pulse Width Modulation	Yes	Yes	—
22	—	—	—	—
23	OSC 2 Pitch Modulation	Yes	Yes	—
24	OSC 2 Tone Modulation	Yes	Yes	—
25	OSC 2 Pitch	Yes	Yes	—
26	OSC 2 Level	Yes	Yes	—
27	Noise Level	Yes	Yes	—
28	Unison Detune	Yes	Yes	—
29	VCF Frequency	Yes	Yes	—
30	VCF Resonance	Yes	Yes	—
31	VCF Envelope Modulation	Yes	Yes	—
32	Bank Select (LSB)	Yes	Yes	—
33	VCF LFO Modulation	Yes	Yes	Replaces: Modulation Wheel (LSB)
34	VCF Keyboard Modulation	Yes	Yes	Replaces: Breath Controller (LSB)
35	HPF Frequency	Yes	Yes	—
36	VCA Level	Yes	Yes	Replaces: Foot Controller (LSB)
37	VCA Envelope Attack	Yes	Yes	Replaces: Portamento Time (LSB)
38	Data Entry (LSB)	Yes	Yes	—
39	VCA Envelope Decay	Yes	Yes	Replaces: Channel Volume (LSB)
40	VCA Envelope Sustain	Yes	Yes	Replaces: Balance (LSB)
41	VCA Envelope Release	Yes	Yes	—
42	VCF Envelope Attack	Yes	Yes	—
43	VCF Envelope Decay	Yes	Yes	Replaces: Pan (LSB)
44	VCA Envelope Sustain	Yes	Yes	Replaces: Expression (LSB)
45	VCF Envelope Release	Yes	Yes	Replaces: Effect Control 1 (LSB)
46	MOD Envelope Attack	Yes	Yes	Replaces: Effect Control 2 (LSB)
47	MOD Envelope Decay	Yes	Yes	—
48	MOD Envelope Sustain	Yes	Yes	—
49	MOD Envelope Release	Yes	Yes	Replaces: General Purpose Controller 1 (LSB)
50	VCA Envelope Attack Curve	Yes	Yes	Replaces: General Purpose Controller 2 (LSB)

**MIDI Implementation Chart v. 2.0 Control Number Information Page 2 of 3**Manufacturer: **Behringer** Model: **DeepMind 12** Version: **1.0** Date: **01 September 2016****1. Basic Information**

Control #	Function	Transmitted (Y/N)	Recognized (Y/N)	Remarks
51	VCA Envelope Decay Curve	Yes	Yes	Replaces: General Purpose Controller 3 (LSB)
52	VCA Envelope Sustain Curve	Yes	Yes	Replaces: General Purpose Controller 4 (LSB)
53	VCA Envelope Release Curve	Yes	Yes	—
54	VCF Envelope Attack Curve	Yes	Yes	—
55	VCF Envelope Decay Curve	Yes	Yes	—
56	VCA Envelope Sustain Curve	Yes	Yes	—
57	VCF Envelope Release Curve	Yes	Yes	—
58	MOD Envelope Attack Curve	Yes	Yes	—
59	MOD Envelope Decay Curve	Yes	Yes	—
60	MOD Envelope Sustain Curve	Yes	Yes	—
61	MOD Envelope Release Curve	Yes	Yes	—
62	Effects Slot 1 Parameter 1	Yes	Yes	—
63	Effects Slot 1 Parameter 2	Yes	Yes	—
64	Sustain Pedal	Yes	Yes	—
65	Effects Slot 1 Parameter 3	Yes	Yes	Replaces: Portamento On/Off
66	Effects Slot 1 Parameter 4	Yes	Yes	Replaces: Sostenuato
67	Effects Slot 1 Parameter 5	Yes	Yes	Replaces: Soft Pedal
68	Effects Slot 1 Parameter 6	Yes	Yes	Replaces: Legato Footswitch
69	Effects Slot 1 Parameter 7	Yes	Yes	Replaces: Hold 2
70	Effects Slot 1 Parameter 8	Yes	Yes	Replaces: Sound Controller 1 (default: Sound Variation)
71	Effects Slot 1 Parameter 9	Yes	Yes	Replaces: Sound Controller 2 (default: Timbre / Harmonic Quality)
72	Effects Slot 1 Parameter 10	Yes	Yes	Replaces: Sound Controller 3 (default: Release Time)
73	Effects Slot 1 Parameter 11	Yes	Yes	Replaces: Sound Controller 4 (default: Attack Time)
74	Effects Slot 1 Parameter 12	Yes	Yes	Replaces: Sound Controller 5 (default: Brightness)
75	Effects Slot 2 Parameter 1	Yes	Yes	Replaces: Sound Controller 6 (GM2 default: Decay Time)
76	Effects Slot 2 Parameter 2	Yes	Yes	Replaces: Sound Controller 7 (GM2 default: Vibrato Rate)
77	Effects Slot 2 Parameter 3	Yes	Yes	Replaces: Sound Controller 8 (GM2 default: Vibrato Depth)
78	Effects Slot 2 Parameter 4	Yes	Yes	Replaces: Sound Controller 9 (GM2 default: Vibrato Delay)
79	Effects Slot 2 Parameter 5	Yes	Yes	Replaces: Sound Controller 10 (GM2 default: Undefined)
80	Effects Slot 2 Parameter 6	Yes	Yes	Replaces: General Purpose Controller 5
81	Effects Slot 2 Parameter 7	Yes	Yes	Replaces: General Purpose Controller 6
82	Effects Slot 2 Parameter 8	Yes	Yes	Replaces: General Purpose Controller 7
83	Effects Slot 2 Parameter 9	Yes	Yes	Replaces: General Purpose Controller 8
84	Effects Slot 2 Parameter 10	Yes	Yes	Replaces: Portamento Control
85	Effects Slot 2 Parameter 11	Yes	Yes	—
86	Effects Slot 2 Parameter 12	Yes	Yes	—
87	Effects Slot 3 Parameter 1	Yes	Yes	—
88	Effects Slot 3 Parameter 2	Yes	Yes	—
89	Effects Slot 3 Parameter 3	Yes	Yes	—
90	Effects Slot 3 Parameter 4	Yes	Yes	—
91	Effects Slot 3 Parameter 5	Yes	Yes	Replaces: Effects 1 Depth (default: Reverb Send)
92	Effects Slot 3 Parameter 6	Yes	Yes	Replaces: Effects 2 Depth (default: Tremolo Depth)
93	Effects Slot 3 Parameter 7	Yes	Yes	Replaces: Effects 3 Depth (default: Chorus Send)
94	Effects Slot 3 Parameter 8	Yes	Yes	Replaces: Effects 4 Depth (default: Celeste [Detune] Depth)
95	Effects Slot 3 Parameter 9	Yes	Yes	Replaces: Effects 5 Depth (default: Phaser Depth)
96	Data Increment	Yes	Yes	—
97	Data Decrement	Yes	Yes	—
98	Non-Registered Parameter Number (LSB)	Yes	Yes	—
99	Non-Registered Parameter Number (MSB)	Yes	Yes	—
100	Registered Parameter Number (LSB)	Yes	Yes	—

## MIDI Implementation Chart v. 2.0 Control Number Information Page 3 of 3

Manufacturer: Behringer Model: DeepMind 12 Version:1.0 Date: 01 September 2016

## 1. Basic Information

Control #	Function	Transmitted (Y/N)	Recognized (Y/N)	Remarks
101	Registered Parameter Number(MSB)	Yes	Yes	—
102	Effects Slot 3 Parameter 10	Yes	Yes	—
103	Effects Slot 3 Parameter 11	Yes	Yes	—
104	Effects Slot 3 Parameter 12	Yes	Yes	—
105	Effects Slot 1 Type	Yes	Yes	—
106	Effects Slot 2 Type	Yes	Yes	—
107	Effects Slot 3 Type	Yes	Yes	—
108	Effects Slot 4 Type	Yes	Yes	—
109	Effects Slot 1 Gain	Yes	Yes	—
110	Effects Slot 2 Gain	Yes	Yes	—
111	Effects Slot 3 Gain	Yes	Yes	—
112	Effects Slot 4 Gain	Yes	Yes	—
113	Analog Thru	Yes	Yes	—
114	Effects Mode	Yes	Yes	—
115	3D Controller X-Axis	Yes	Yes	—
116	3D Controller Y-Axis	Yes	Yes	—
117	3D Controller Z-Axis	Yes	Yes	—
118	—	—	—	—
119	—	—	—	—
120	All Sound Off	Yes	Yes	—
121	Reset All Controllers	Yes	Yes	—
122	Local Control On/Off	Yes	Yes	—
123	All Notes Off	Yes	Yes	—
124	Omni Mode Off	Yes	Yes	—
125	Omni Mode On	Yes	Yes	—
126	Poly Mode Off	Yes	Yes	—
127	Poly Mode On	Yes	Yes	—

## 17. MIDI NRPN Commands

NRPN (Non-Registered Parameter Numbers) are a special type of MIDI communication that allows control of parameters that are not defined in the basic MIDI standard. NRPNs work by using groups of defined controller messages to expand the number of available parameter numbers and also to extend the maximum resolution. For more information on NRPNs and their implementation please consult the MIDI Manufacturers Association at [www.midi.org](http://www.midi.org). For specific information regarding the support of NRPN data within any Audio/MIDI application please consult the manufacturer.

An NRPN message consists the following byte sequence

The Data Entry (MSB) message is optional and can be ignored for switch parameters or any parameters which have a range of 0-127 or less.

**Note :** When Running Status is taken into account, this bytes sequence is reduced to.. B0, 63, aa, 62, bb, 06, cc, 26, dd.

**Note :** Once the NRPN parameter ID has been selected with the first two messages if the previously selected parameter is changed again (i.e. user is moving a single control) then the first two messages can be omitted leaving just the Data Entry LSB & MSB messages.

**Note :** The DeepMind 12 treats NPRNs from USB, Wi-Fi & the physical MIDI ports separately i.e. it has a 'selected NPRN parameter' for each interface.

The NRPN implementation of the DeepMind 12 is listed in the table below:

MSB	LSB	14-bit	Parameter Name	Range	Notes
0	0	00	LFO 1 Rate	0-255	—
0	1	01	LFO 1 Delay / Fade	0-255	—
0	2	02	LFO 1 Shape	0-6	Sine (0), Triangle (1), Square (2), Ramp Up (3), Ramp Down (4), Sample & Hold (5), Sample & Glide (6)
0	3	03	LFO 1 Key Sync	0-1	Off (0), On (1)
0	4	04	LFO 1 Arp Sync	0-1	Off (0), On (1)
0	5	05	LFO 1 Mono Mode	0-1	Poly (0) Mono (1) or SPREAD-1(2) to SPREAD-254(255)
0	6	06	LFO 1 Slew Rate	0-255	—
0	7	07	LFO 2 Rate	0-255	—
0	8	08	LFO 2 Delay / Fade	0-255	—
0	9	09	LFO 2 Shape	0-6	Sine (0), Triangle (1), Square (2), Ramp Up (3), Ramp Down (4), Sample & Hold (5), Sample & Glide (6)
0	10	10	LFO 2 Key Sync	0-1	Off (0), On (1)
0	11	11	LFO 2 Arp Sync	0-1	Off (0), On (1)
0	12	12	LFO 2 Mono Mode	0-255	Poly (0) Mono (1) or SPREAD-1(2) to SPREAD-254(255)
0	13	13	LFO 2 Slew Rate	0-255	—
0	14	14	OSC 1 Range	0-2	16' (0), 8' (1), 4' (2)
0	15	15	OSC 2 Range	0-2	16' (0), 8' (1), 4' (2)
0	16	16	OSC 1 PWM Source	0-5	Manual (0), LFO 1 (1), LFO 2 (2), VCA Env (3), VCF Env (4), Mod Env (5)
0	17	17	OSC 2 Tone Mod Source	0-5	Manual (0), LFO 1 (1), LFO 2 (2), VCA Env (3), VCF Env (4), Mod Env (5)
0	18	18	OSC 1 Pulse Enable	0-1	Off (0), On (1)
0	19	19	OSC 1 Saw Enable	0-1	Off (0), On (1)
0	20	20	OSC Sync Enable	0-1	Off (0), On (1)
0	21	21	OSC 1 Pitch Mod Depth	0-255	—
0	22	22	OSC 1 Pitch Mod Select	0-6	LFO 1 (0), LFO 2 (1), VCA Env (2), VCF Env (3), Mod Env (4), LFO 1 Unipolar (5), LFO 2 Unipolar (6)
0	23	23	OSC 1 Aftertouch > Pitch Mod Depth	0-255	—
0	24	24	OSC 1 Mod Wheel > Pitch Mod Depth	0-255	—
0	25	25	OSC 1 PWM Depth	0-255	—
0	26	26	OSC 2 Level	0-255	—
0	27	27	OSC 2 Pitch	0-255	—
0	28	28	OSC 2 Tone Mod Depth	0-255	—
0	29	29	OSC 2 Pitch Mod Depth	0-255	—
0	30	30	OSC 2 Aftertouch > Pitch Mod Depth	0-255	—
0	31	31	OSC 2 Mod Wheel > Pitch Mod Depth	0-255	—
0	32	32	OSC 2 Pitch Mod Select	0-6	LFO 1 (0), LFO 2 (1), VCA Env (2), VCF Env (3), Mod Env (4), LFO 1 Unipolar (5), LFO 2 Unipolar (6)
0	33	33	Noise Level	0-255	—
0	34	34	Portamento time	0-255	—
0	35	35	Portamento mode	0-13	Normal (0), Fingered (1), Fixed Rate (2), Fixed Rate Fingered (3), Exponential (4), Exponential Fingered (5), Fixed +2 (6), Fixed -2 (7), Fixed +5 (8), Fixed -5 (9), Fixed +12 (10), Fixed -12 (11), Fixed +24 (12), Fixed -24 (13)
0	36	36	Pitch bend Up depth	0-24	In steps of 1 semitone
0	37	37	Pitch bend Down depth	0-24	In steps of 1 semitone
0	38	38	OSC 1 Pitch Mod Mode	0-1	0 ( OSC1+2), 1 (OSC 1 Only)
0	39	39	VCF Frequency	0-255	—
0	40	40	VCF HighPass Frequency	0-255	—
0	41	41	VCF Resonance	0-255	—
0	42	42	VCF Envelope Depth	0-255	—
0	43	43	VCF Envelope Velocity Sensitivity	0-255	—
0	44	44	VCF Pitch Bend to Freq Depth	0-255	—

MSB	LSB	14-bit	Parameter Name	Range	Notes
0	45	45	VCF LFO Depth	0-255	
0	46	46	VCF LFO Select	0-1	LFO 1 (0), LFO 2 (1)
0	47	47	VCF Aftertouch > LFO Depth	0-255	
0	48	48	VCF Mod Wheel > LFO Depth	0-255	
0	49	49	VCF Keyboard Tracking	0-255	
0	50	50	VCF Envelope Polarity	0-1	Negative (0), Positive (1)
0	51	51	VCF 2 Pole Mode	0-1	4 Pole (0), 2 Pole (1)
0	52	52	VCF Bass Boost	0-1	Off (0), On (1)
0	53	53	VCA Envelope Attack Time	0-255	
0	54	54	VCA Envelope Decay Time	0-255	
0	55	55	VCA Envelope Sustain Level	0-255	
0	56	56	VCA Envelope Release Time	0-255	
0	57	57	VCA Envelope Trigger Mode	0-4	Key (0), LFO 1 (1), LFO 2 (2), Loop (3), Control Sequencer Step (4)
0	58	58	VCA Envelope Attack Curve	0-255	
0	59	59	VCA Envelope Decay Curve	0-255	
0	60	60	VCA Envelope Sustain Curve	0-255	
0	61	61	VCA Envelope Attack Curve	0-255	
0	62	62	VCF Envelope Attack Time	0-255	
0	63	63	VCF Envelope Decay Time	0-255	
0	64	64	VCF Envelope Sustain Level	0-255	
0	65	65	VCF Envelope Release Time	0-255	
0	66	66	VCF Envelope Trigger Mode	0-4	Key (0), LFO 1 (1), LFO 2 (2), Loop (3), Control Sequencer Step (4)
0	67	67	VCF Envelope Attack Curve	0-255	
0	68	68	VCF Envelope Decay Curve	0-255	
0	69	69	VCF Envelope Sustain Curve	0-255	
0	70	70	VCF Envelope Attack Curve	0-255	
0	71	71	Mod Envelope Attack Time	0-255	
0	72	72	Mod Envelope Decay Time	0-255	
0	73	73	Mod Envelope Sustain Level	0-255	
0	74	74	Mod Envelope Release Time	0-255	
0	75	75	Mod Envelope Trigger Mode	0-4	Key (0), LFO 1 (1), LFO 2 (2), Loop (3), Control Sequencer Step (4)
0	76	76	Mod Envelope Attack Curve	0-255	
0	77	77	Mod Envelope Decay Curve	0-255	
0	78	78	Mod Envelope Sustain Curve	0-255	
0	79	79	Mod Envelope Attack Curve	0-255	
0	80	80	VCA Level	0-255	
0	81	81	VCA Envelope Depth	0-255	
0	82	82	VCA Envelope Velocity Sensitivity	0-255	
0	83	83	VCA Pan Spread	0-255	-128 (0) to +127 (255)
0	84	84	Voice Priority Mode	0-2	Lowest (0), Highest (1), Last (2)
0	85	85	Polyphony Mode	0-12	Poly (0), Unison 2 (1), Unison 3 (2), Unison 4 (3), Unison 6 (4), Unison 12 (5), Mono (6), Mono 2 (7), Mono 3 (8), Mono 4 (9), Mono 6 (10), Poly 6 (11), Poly 8 (12)
0	86	86	Envelope Trigger Mode	0-3	Mono (0), Re-Trigger (1), Legato (2), One-Shot (3)
0	87	87	Unison Detune	0-255	Sets the amount phatness!
0	88	88	Voice Drift	0-255	
0	89	89	Parameter Drift	0-255	
0	90	90	Drift Rate	0-255	
0	91	91	OSC Portamento Balance	0-255	-128 (0) to +127 (255)
0	92	92	OSC Key Down Reset	0-1	Off (0), On (1)
0	93	93	Mod 1 Source	0-22	See Modulation Matrix Source List
0	94	94	Mod 1 Destination	0-129	See Modulation Matrix Destination List
0	95	95	Mod 1 Depth	0-255	-128 (0) to +127 (255)
0	96	96	Mod 2 Source	0-22	See Modulation Matrix Source List
0	97	97	Mod 2 Destination	0-129	See Modulation Matrix Destination List
0	98	98	Mod 2 Depth	0-255	-128 (0) to +127 (255)
0	99	99	Mod 3 Source	0-22	See Modulation Matrix Source List
0	100	100	Mod 3 Destination	0-129	See Modulation Matrix Destination List
0	101	101	Mod 3 Depth	0-255	-128 (0) to +127 (255)
0	102	102	Mod 4 Source	0-22	See Modulation Matrix Source List
0	103	103	Mod 4 Destination	0-129	See Modulation Matrix Destination List
0	104	104	Mod 4 Depth	0-255	-128 (0) to +127 (255)
0	105	105	Mod 5 Source	0-22	See Modulation Matrix Source List

MSB	LSB	14-bit	Parameter Name	Range	Notes
0	106	106	Mod 5 Destination	0-129	See Modulation Matrix Destination List
0	107	107	Mod 5 Depth	0-255	-128 (0) to +127 (255)
0	108	108	Mod 6 Source	0-22	See Modulation Matrix Source List
0	109	109	Mod 6 Destination	0-129	See Modulation Matrix Destination List
0	110	110	Mod 6 Depth	0-255	-128 (0) to +127 (255)
0	111	111	Mod 7 Source	0-22	See Modulation Matrix Source List
0	112	112	Mod 7 Destination	0-129	See Modulation Matrix Destination List
0	113	113	Mod 7 Depth	0-255	-128 (0) to +127 (255)
0	114	114	Mod 8 Source	0-22	See Modulation Matrix Source List
0	115	115	Mod 8 Destination	0-129	See Modulation Matrix Destination List
0	116	116	Mod 8 Depth	0-255	-128 (0) to +127 (255)
0	117	117	Ctrl Sequencer Enable	0-1	Off (0), On (1)
0	118	118	Ctrl Sequencer Clock Divider	0-15	See Control Sequencer divider table
0	119	119	Sequence Length	0-31	1 (0) to 32 (31) steps
0	120	120	Sequencer Swing Timing	0-25	50% (0) to 75% (25)
0	121	121	Key Sync & Loop	0-2	Loop On (0), Key Sync On (1), Loop & Key Sync On (2)
0	122	122	Slew Rate	0-255	
0	123	123	Seq Step Value 1	0-255	Bipolar step value -127 (1) to +127 (255). A value of 0 is "skip step".
0	124	124	Seq Step Value 2	0-255	Bipolar step value -127 (1) to +127 (255). A value of 0 is "skip step".
0	125	125	Seq Step Value 3	0-255	Bipolar step value -127 (1) to +127 (255). A value of 0 is "skip step".
0	126	126	Seq Step Value 4	0-255	Bipolar step value -127 (1) to +127 (255). A value of 0 is "skip step".
0	127	127	Seq Step Value 5	0-255	Bipolar step value -127 (1) to +127 (255). A value of 0 is "skip step".
1	0	128	Seq Step Value 6	0-255	Bipolar step value -127 (1) to +127 (255). A value of 0 is "skip step".
1	1	129	Seq Step Value 7	0-255	Bipolar step value -127 (1) to +127 (255). A value of 0 is "skip step".
1	2	130	Seq Step Value 8	0-255	Bipolar step value -127 (1) to +127 (255). A value of 0 is "skip step".
1	3	131	Seq Step Value 9	0-255	Bipolar step value -127 (1) to +127 (255). A value of 0 is "skip step".
1	4	132	Seq Step Value 10	0-255	Bipolar step value -127 (1) to +127 (255). A value of 0 is "skip step".
1	5	133	Seq Step Value 11	0-255	Bipolar step value -127 (1) to +127 (255). A value of 0 is "skip step".
1	6	134	Seq Step Value 12	0-255	Bipolar step value -127 (1) to +127 (255). A value of 0 is "skip step".
1	7	135	Seq Step Value 13	0-255	Bipolar step value -127 (1) to +127 (255). A value of 0 is "skip step".
1	8	136	Seq Step Value 14	0-255	Bipolar step value -127 (1) to +127 (255). A value of 0 is "skip step".
1	9	137	Seq Step Value 15	0-255	Bipolar step value -127 (1) to +127 (255). A value of 0 is "skip step".
1	10	138	Seq Step Value 16	0-255	Bipolar step value -127 (1) to +127 (255). A value of 0 is "skip step".
1	11	139	Seq Step Value 17	0-255	Bipolar step value -127 (1) to +127 (255). A value of 0 is "skip step".
1	12	140	Seq Step Value 18	0-255	Bipolar step value -127 (1) to +127 (255). A value of 0 is "skip step".
1	13	141	Seq Step Value 19	0-255	Bipolar step value -127 (1) to +127 (255). A value of 0 is "skip step".
1	14	142	Seq Step Value 20	0-255	Bipolar step value -127 (1) to +127 (255). A value of 0 is "skip step".
1	15	143	Seq Step Value 21	0-255	Bipolar step value -127 (1) to +127 (255). A value of 0 is "skip step".
1	16	144	Seq Step Value 22	0-255	Bipolar step value -127 (1) to +127 (255). A value of 0 is "skip step".
1	17	145	Seq Step Value 23	0-255	Bipolar step value -127 (1) to +127 (255). A value of 0 is "skip step".
1	18	146	Seq Step Value 24	0-255	Bipolar step value -127 (1) to +127 (255). A value of 0 is "skip step".
1	19	147	Seq Step Value 25	0-255	Bipolar step value -127 (1) to +127 (255). A value of 0 is "skip step".
1	20	148	Seq Step Value 26	0-255	Bipolar step value -127 (1) to +127 (255). A value of 0 is "skip step".
1	21	149	Seq Step Value 27	0-255	Bipolar step value -127 (1) to +127 (255). A value of 0 is "skip step".
1	22	150	Seq Step Value 28	0-255	Bipolar step value -127 (1) to +127 (255). A value of 0 is "skip step".
1	23	151	Seq Step Value 29	0-255	Bipolar step value -127 (1) to +127 (255). A value of 0 is "skip step".
1	24	152	Seq Step Value 30	0-255	Bipolar step value -127 (1) to +127 (255). A value of 0 is "skip step".
1	25	153	Seq Step Value 31	0-255	Bipolar step value -127 (1) to +127 (255). A value of 0 is "skip step".
1	26	154	Seq Step Value 32	0-255	Bipolar step value -127 (1) to +127 (255). A value of 0 is "skip step".
1	27	155	Arp On/Off	0-1	Off (0), On (1)
1	28	156	Arp Mode	0-10	Up (0), Down (1), Up&Down (2), Up Inv (3), Down Inv (4), Up&Down Inv (5), Up Alt (6), Down Alt (7), Random (8), As Played (9), Chord (10)
1	29	157	Arp Rate (tempo)	0-255	20 bpm (0) to 275 bpm (255)
1	30	158	Arp Clock	0-12	See Arpeggiator clock divider table
1	31	159	Arp Key Sync	0-1	Off (0), On (1)
1	32	160	Arp Gate Time	0-255	
1	33	161	Arp Hold	0-1	Off (0), On (1)
1	34	162	Arp Pattern	0-64	None (0), Preset-1 (1) ... User-1 (33) ... User-32 (64)
1	35	163	Arp Swing	0-25	50% (0) to 75% (25)
1	36	164	Arp Octaves	0-5	1 to 6 Octaves
1	37	165	FX Routing	0-9	See FX Connection Modes
1	38	166	FX 1 Type	0-33	See FX Type list

MSB	LSB	14-bit	Parameter Name	Range	Notes
1	39 - 50	167 - 178	FX 1 Params	0-255	FX Slot 1 Parameters
1	51	179	FX 2 Type	0-33	See FX Type list
1	52 - 63	180 - 191	FX 2 Params	0-255	FX Slot 2 Parameters
1	64	192	FX 3 Type	0-33	See FX Type list
1	65 - 76	193 - 204	FX 3 Params	0-255	FX Slot 3 Parameters
1	77	205	FX 4 Type	0-33	See FX Type list
1	78 - 89	206 - 217	FX 4 Params	0-255	FX Slot 4 Parameters
1	90	218	FX 1 Output Gain	0-150	—
1	91	219	FX 2 Output Gain	—	—
1	92	220	FX 3 Output Gain	—	—
1	93	221	FX 4 Output Gain	0-150	Output gain for FX slots 1-4
1	94	222	FX Mode	0-2	Insert (0), Send (1), Bypass (2)
1	95 - 111	223 - 239	Program Name	0-127	Null terminated Program name. 16(+1) char ASCII string.
1	112	240	Program Category	0-16	See program category table
1	113	241	Program Transpose	80 - 176	-48 (80) ... 0 ( 128) ... 176 (+48)

## 18. Global Commands

Parameter Name	Range	Description
MIDI Channel	0-16	Sets MIDI Rx / Tx channel. 0 = All, 1 = Ch1 ... 16 = Ch16
Keyboard Local	0-1	Sets the keyboard, mod and pitch wheels 'local' mode, i.e whether they control the synth (1) or just send MIDI (0)
Fader Local	0-1	Sets the fader local mode, i.e whether the faders control the synth (1) or just send MIDI (0)
Global Tune	0-255	0=-128 cents, 128=0 cents 255 = +127 cents
MIDI Clock Source	0-2	Sets the source for the Arp clock. MenuItemMidiClock_e (Internal, MIDI, USB)
MIDI Program Change Mode	0-2	Sets whether the synth receives or sends Program changes or both. MenuItemProgramChangeMode_e (Rx, Tx, Both)
USB Control mode	0-2	Sets whether the synth sends CC (eg for controlling a soft synth) or NRPN messages to USB (for our iOS App) - this is set automatically when an app notify message is received.
MIDI Control mode	0-2	Sets whether the synth sends CC (eg for controlling another synth) or NRPN messages to MIDI (for our VST App) - this is set automatically when an app notify message is received.
MIDI Soft Thru	0-1	Sets whether the synth forwards messages received on MIDI In to MIDI Out (Off, On).
USB to MIDI	0-1	Sets whether the synth forwards messages received on USB to MIDI Out (Off, On)
MIDI to USB	0-1	Sets whether the synth forwards messages received on MIDI In to USB (Off, On)
Fixed Velocity	0-1	Sets whether the keyboard sends fixed (1) or dynamic (0) velocity as part of a Note On message.
Velocity	0-127	Sets the velocity sent when in fixed mode.
Velocity Curve	0-127	(-64 : +63 - TBD) sets the curve used to convert key velocity into MIDI note velocity - adjust to suit style of playing
Transpose	0-96	(-48 : 48) set the keyboard transpose amount (affects local & MIDI operation)
Aftertouch Curve	0-127	(-64 : +63 TBD) sets the curve used to convert key pressure into MIDI aftertouch - adjust to suit style of playing
Pedal CC	0-3	Sets the MIDI Controller sent by the foot controller pedal input ( Foot Control (CC4), Breath (CC3), Volume (CC7), Expression (CC11)
Sustain CC	0-3	Sets the polarity and function of the sustain pedal switch (Normal+, Normal-, Arp(+), Arp(-))
Fader Pick Up Mode	0-2	Set the Fader pick-up mode (Relative, Pass-thru, Jump)
LCD Brightness	0-9	Sets the LCD brightness in 10% steps (10% to 100%)
LCD Contrast	0-9	Sets the LCD contrast in 10% steps (10% to 100%)
Arp Send to MIDI	0-1	Enables transmission of arpeggiator output to MIDI out (both USB and physical MIDI)
Send NRPN on load	0-2	(may be removed for release version) - Dumps NRPN values when a new program is loaded (mainly for ctrlr) MenuItemSendNrpnOnLoad_e (Off, MIDI, USB)
Keyboard Octave	0-7	(0-MAX_KEYBOARD_OCT) Sets octave shift for keyboard. At 0, left most key is C0



## 19. MIDI SysEx Commands

SysEx (System Exclusive) are a special type of MIDI communication that allows control of parameters and settings on a device/manufacture specific basis. For more information on SysEx and its implementation please consult the MIDI Manufacturers Association at [www.midi.org](http://www.midi.org). For specific information regarding the support of SysEx data within any third party Audio/MIDI applications please consult the manufacturer.

The SysEx implementation of the DeepMind 12 is described in the following sections:

### 19.2.1 Universal System Exclusive Message (Device Inquiry)

This message can be used to detect the presence of the synth and to get the current global MIDI channel setting (also used as a Sysex Device ID when addressing the synth).

#### DEVICE ENQUIRY SYSEX REQUEST

MIDI Bytes	Description
F0	System Exclusive Status Byte
7E	Non Real Time Message Code
nn or 7F	Device ID (0-15) or 7F for broadcast
06	General Information Message Code
01	Identity Request Message Code
F7	End of System Exclusive

#### DEVICE ENQUIRY SYSEX RESPONSE

MIDI Bytes	Description
F0	System Exclusive Status Byte
7E	Non Real Time Message Code
nn	Device ID of unit 0-15
06	General Information Message Code
01	Identity Reply Message Code
00, 20, 32	Behringer Manufacturers ID
20	DeepMind12 Product Family ID Code (LSByte)
00	DeepMind12 Product Family ID Code (MSByte)
01	DeepMind12 Family Member ID Code (LSByte)
00	DeepMind12 Family Member ID Code (MSByte)
jn	Main Software Version Revision Information j = minor revision (0-7) n=major revision (0-15)
00	Reserved
ii	Voice Software Major Version Number (0-127)
nn	Voice Software Minor Version Number (0-127)
F7	End of System Exclusive
01	Identity Request Message Code
F7	End of System Exclusive

### 19.2.2 App Notify Messages

This message is transmitted to the synth to identify that there is a control app connected on a particular MIDI interface. The synth, on receiving this message will ensure that NPRN and sysex messages are enabled on this interface and then will reply with device ID, rx/tx channels and interface ID of the interface which the app notify message was received on. When an app is connected on an interface, the unit sends out additional sysex messages such as key down & voice allocation update messages

#### APP NOTIFY REQUEST

MIDI Bytes	Description
F0	System Exclusive Status Byte
00, 20, 32,	Behringer Manufacturers ID
20	DeepMind 12 Model ID
0d	Device ID 0-15
00	Control App Notify
rr	reserved
F7	End of System Exclusive

APP NOTIFY RESPONSE

MIDI Bytes	Description
F0	System Exclusive Status Byte
00, 20, 32	Behringer Manufacturers ID
20	DeepMind 12 Model ID
0d	Device ID 0-15
10	Control App Notify Response
rx	Midi Receive Ch 0-16 (All, 1-16)
tx	Midi Transmit Ch 0-15 (1-16)
if	Interface ID (0=MIDI 1=USB 2=Wifi)
cb	Currently selected bank (0-7)
cp	Currently selected program (0-127)
F7	End of System Exclusive
00	Reserved
ii	Voice Software Major Version Number (0-127)
nn	Voice Software Minor Version Number (0-127)
F7	End of System Exclusive
01	Identity Request Message Code
F7	End of System Exclusive

19.2.3 Bulk Dump Packed Data Format

The bulk dumps listed below all use "Packed MS bit" format data packing so a raw data set of 7 bytes x 8 bits are transmitted as 8 bytes of 7-bits (MSB is 0 for sysex message data) with the MSBs of the original bytes packed into the first bytes of the 8 byte transmitted sequence.

DATA ( 1set = 8bit x 7byte )

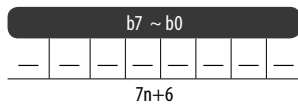
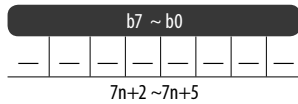
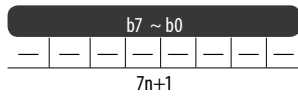

MIDI DATA ( 1set = 7bit x 8byte )

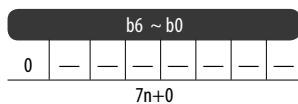
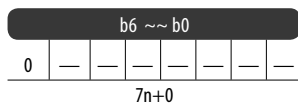
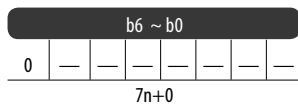
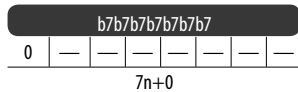

## 19.2.4 Dump Messages

These messages can be used to request a data dump and are shown with their responses. Each parameter is stored in its own byte and the data format is documented in the NRPN table.

### PROGRAM DUMP REQUEST

MIDI Bytes	Description
F0	System Exclusive Start
00, 20, 32	Behringer Manufacturers ID
20	DeepMind12 Model ID
0d	Device ID ( 0-15 )
01	Program Dump Request
0b	Bank Number (0-7)
pp	Program Number (0-127)
F7	End of System Exclusive

### PROGRAM DUMP RESPONSE

MIDI Bytes	Description
F0	System Exclusive Start
00, 20, 32	Behringer Manufacturers ID
20	DeepMind12 Model ID
0d	Device ID ( 0-15 )
02	Program Dump Response
06	Comms Protocol Version
0b	Bank Number (0-7)
pp	Program Number (0-127)
—	242 bytes of Program Data packed into 278 7-bit message bytes.
F7	End of System Exclusive

### EDIT BUFFER DUMP REQUEST

MIDI Bytes	Description
F0	System Exclusive Start
00, 20, 32	Behringer Manufacturers ID
20	DeepMind12 Model ID
0d	Device ID ( 0-15 )
03	Edit Buffer Dump Request
F7	End of System Exclusive

### EDIT BUFFER DUMP RESPONSE

MIDI Bytes	Description
F0	System Exclusive Start
00, 20, 32	Behringer Manufacturers ID
20	DeepMind12 Model ID
0d	Device ID ( 0-15 )
04	Edit Buffer Dump Response
06	Comms Protocol Version
—	242 bytes of Program Data packed into 278 7-bit message bytes.
F7	End of System Exclusive

### GLOBAL PARAMETER DUMP REQUEST

MIDI Bytes	Description
F0	System Exclusive Start
00, 20, 32	Behringer Manufacturers ID
20	DeepMind12 Model ID
0d	Device ID ( 0-15 )
05	Global Parameter Dump Request
F7	End of System Exclusive

**GLOBAL PARAMETER DUMP RESPONSE**

MIDI Bytes	Description
F0	System Exclusive Start
00, 20, 32	Behringer Manufacturers ID
20	DeepMind12 Model ID
0d	Device ID ( 0-15 )
06	Global Parameter Dump Response
06	Comms Protocol Version
—	45 Bytes of Global Data packed into 56 7-bit message bytes.
F7	End of System Exclusive

**SINGLE USER PATTERN DUMP REQUEST**

MIDI Bytes	Description
F0	System Exclusive Start
00, 20, 32	Behringer Manufacturers ID
20	DeepMind12 Model ID
0d	Device ID ( 0-15 )
07	Single User Pattern Dump Request
pp	Pattern Number (0-31)
F7	End of System Exclusive

**SINGLE USER PATTERN DUMP RESPONSE**

MIDI Bytes	Description
F0	System Exclusive Start
00, 20, 32	Behringer Manufacturers ID
20	DeepMind12 Model ID
0d	Device ID ( 0-15 )
08	Single User Pattern Dump Response
06	Comms Protocol Version
pp	Pattern Number (0-31)
—	65 byte User Pattern packed into 80 7-bit message bytes. User pattern data is 1 byte length followed by 32 bytes for step velocity and 32 bytes for step gate
F7	End of System Exclusive

**EDIT BUFFER PATTERN DUMP REQUEST**

MIDI Bytes	Description
F0	System Exclusive Start
00, 20, 32	Behringer Manufacturers ID
20	DeepMind12 Model ID
0d	Device ID ( 0-15 )
0E	Edit Buffer Pattern Dump Request
F7	End of System Exclusive

**EDIT BUFFER PATTERN DUMP RESPONSE**

MIDI Bytes	Description
F0	System Exclusive Start
00, 20, 32	Behringer Manufacturers ID
20	DeepMind12 Model ID
0d	Device ID ( 0-15 )
08	Edit Buffer Pattern Dump Response
06	Comms Protocol Version
—	65 byte User Pattern packed into 80 7-bit message bytes.
F7	End of System Exclusive

**PROGRAM BANK DUMP REQUEST (Response is individual program dump responses in a sequence)**

MIDI Bytes	Description
F0	System Exclusive Start
00, 20, 32	Behringer Manufacturers ID
20	DeepMind12 Model ID
0d	Device ID ( 0-15 )
09	Bank Dump Request
bb	Bank Number (0-7)
ff	First Program (0-127)
ll	Last program (0-127)
F7	End of System Exclusive

**PROGRAM BANK NAMES DUMP REQUEST**

MIDI Bytes	Description
F0	System Exclusive Start
00, 20, 32	Behringer Manufacturers ID
20	DeepMind12 Model ID
0d	Device ID ( 0-15 )
0A	Bank Program Names Dump Request
bb	Bank Number
F7	End of System Exclusive

**PROGRAM BANK NAMES DUMP RESPONSE**

MIDI Bytes	Description
F0	System Exclusive Start
00, 20, 32	Behringer Manufacturers ID
20	DeepMind12 Model ID
0d	Device ID ( 0-15 )
0B	Bank Program Names Dump Response
vv	Comms Protocol Version
bb	Bank Number
—	Program name chars unpacked length = 128 Programs * 16 bytes = 2048 Bytes. Packed data length = 2344
F7	End of System Exclusive

**SINGLE PROGRAM NAME DUMP REQUEST**

MIDI Bytes	Description
F0	System Exclusive Start
00, 20, 32	Behringer Manufacturers ID
20	DeepMind12 Model ID
0d	Device ID ( 0-15 )
0C	Single Program Name Dump Request
bb	Bank Number
pp	Program Number
F7	End of System Exclusive

**SINGLE PROGRAM NAME DUMP RESPONSE**

MIDI Bytes	Description
F0	System Exclusive Start
00, 20, 32	Behringer Manufacturers ID
20	DeepMind12 Model ID
0d	Device ID ( 0-15 )
0D	Bank Program Names Dump Response
06	Comms Protocol Version
bb	Bank Number
—	16 byte Program name packed into 24 bytes
F7	End of System Exclusive

**CALIBRATION DATA DUMP REQUEST**

MIDI Bytes	Description
F0	System Exclusive Start
00, 20, 32	Behringer Manufacturers ID
20	DeepMind12 Model ID
0d	Device ID ( 0-15 )
11	Calibration Data Dump Request
F7	End of System Exclusive

**CALIBRATION DATA DUMP RESPONSE**

MIDI Bytes	Description
F0	System Exclusive Start
00, 20, 32	Behringer Manufacturers ID
20	DeepMind12 Model ID
0d	Device ID ( 0-15 )
12	Calibration Data Dump Response
06	Comms Protocol Version
—	Voice and Controller calibration data packed into 688 7-bit message bytes
F7	End of System Exclusive

**CHORD MEMORY DUMP REQUEST**

MIDI Bytes	Description
F0	System Exclusive Start
00, 20, 32	Behringer Manufacturers ID
20	DeepMind12 Model ID
0d	Device ID ( 0-15 )
1B	Chord Memory Dump Request
F7	End of System Exclusive

**CHORD MEMORY DUMP RESPONSE**

MIDI Bytes	Description
F0	System Exclusive Start
00, 20, 32	Behringer Manufacturers ID
20	DeepMind12 Model ID
0d	Device ID ( 0-15 )
1C	Poly Chord Memory Dump Response
06	Comms Protocol Version
—	26 bytes Chord memory packed into 32 7-bit message bytes. Note unused locations set to 0xFF
F7	End of System Exclusive

**POLY CHORD MEMORY DUMP REQUEST**

MIDI Bytes	Description
F0	System Exclusive Start
00, 20, 32	Behringer Manufacturers ID
20	DeepMind12 Model ID
0d	Device ID ( 0-15 )
1D	Poly Chord Memory Dump Request
F7	End of System Exclusive

**POLY CHORD MEMORY DUMP RESPONSE**

MIDI Bytes	Description
F0	System Exclusive Start
00, 20, 32	Behringer Manufacturers ID
20	DeepMind12 Model ID
0d	Device ID ( 0-15 )
1E	Poly Chord Memory Dump Response
06	Comms Protocol Version
—	512 bytes Poly Chord memory packed into 592 7-bit message bytes. Note unused locations set to 0xFF
F7	End of System Exclusive

## 20. Firmware Update

The DeepMind 12 can receive operating system updates which may add new features or resolve issues. These operating system updates come in the form of "firmware".

To perform a firmware update, follow these steps:

1. Check update availability at [www.behringer.com/DeepMind 12](http://www.behringer.com/DeepMind12)
2. Download update
3. Unzip/Expand files to a folder on your local hard drive.
4. Inside the folder start the "DeepMind Updater" application
5. Follow the instructions in the readme file included with the download.
6. Once complete, enjoy new features/performance.

## 21. Troubleshooting

Before turning on the DeepMind 12 power, please check that:

Your speakers or headphones connected are correctly

The external devices are powered-off

Turn the VOLUME knob on the surface to the 0 position.

Turn on the POWER switch located on the rear panel.

The DeepMind 12 operating system will start and you should see the Behringer logo.

Once the PROG menu is visible you can then turn on power to the connected devices, and raise the volume to an appropriate level.

Before turning off the DeepMind 12 power, please check that:

Turn the output level down on all connected audio devices.

Turn off the power for all connected audio devices.

### 21.1 There is no sound coming from the synthesizer

Check the audio connections are made.

Check the volume control is not down.

Check that keyboard LOCAL setting is ON in the GLOBAL-KEYBOARD SETTINGS menu.

Recall the default program (Press PROG+WRITE). If the default program produces sound then you should examine the program you are trying to use in detail to find any parameter settings which may be preventing the program from producing any audio.

### 21.2 The synthesizer does not to respond when using any of the keys or controls

Check that keyboard LOCAL setting is ON in the GLOBAL-KEYBOARD SETTINGS menu.

### 21.3 The program sounds different in some way

Use the compare function to return all faders to their stored positions/

Ensure the modulation wheel is set to the default position for your program.

### 21.4 There is no MIDI coming from the synthesizer

Check the MIDI connections are made.

Check the MIDI settings for your connection (Physical/USB/Wi-Fi).

### 21.5 The arpeggiator or control sequencer is not running

Check the clock source of the arpeggiator.

### 21.6 Buzzing or humming sounds can be heard in the audio outputs

USB and or audio connections made between devices using different power supplies / sockets can sometimes create ground loops. You can attempt to resolve the grounding issues between the computer and the DeepMind 12 by following good grounding practice and ensuring all devices use the same ground reference. Other possible solutions include using a DI Box where the transformer will isolate the audio connections, or using the physical MIDI sockets which are optically isolated.

### 21.7 When recording MIDI the synthesizer is sending pitch bend signals without touching the pitch wheel.

This can be resolved by running the pitch wheel calibration routine found in the GLOBAL-SYSTEM SETTINGS-CALIBRATE menu

### 21.8 The pitch and/or mod wheel is not responding as expected.

This can be resolved by running the pitch wheel or mod wheel calibration routine found in the GLOBAL-SYSTEM SETTINGS-CALIBRATE menu.

### 21.9 The synthesizer is behaving erratically.

Check that any connected devices/applications are not creating a MIDI loop which is feeding back MIDI data.

### 21.10 The synthesizer sounds out of tune:

Perform the voice calibration routine found in the GLOBAL-SYSTEM SETTINGS-CALIBRATE menu.

### 21.11 The VCF resonance is not tracking notes as expected

Perform the voice calibration routine found in the GLOBAL-SYSTEM SETTINGS-CALIBRATE menu.

## 22. Bootloader Menu



**This menu is for factory or service use only. Improper use may cause damage to the DeepMind 12.**

Note: Please ensure you backup any programs / patterns before using any of the bootloader functionality

To show the bootloader menu follow these steps:

1. Ensure the DeepMind 12 is turned off.
2. Press and hold the PROG and WRITE switches.
3. Turn the DeepMind 12 on.
4. Release the PROG and WRITE switches.

You will now see the bootloader menu, the options are described in this section.

In order to select an option make sure that the '<' symbol on the appropriate CALIBRATE line is highlighted using the BANK/UP and BANK/DOWN switches then press the +/YES switch.

### 22.1 1- Format WiFi Flash

Factory Use Only.

### 22.2 2- MIDI Update

Factory Use Only.

### 22.3 3- Reset Cal Data

This option will reset the calibration data.

### 22.4 4- Reset Chords

This option will reset the chord memory.

### 22.5 5- Reset PolyChords

This option will reset the polychord memory.

### 22.6 6- Reset Globals

This option will reset the global settings.

### 22.7 7- Reset ALL

This option will perform all formatting resetting covered in options 1-5 settings.

### 22.8 8- EXIT

This option will exit the bootloader menu and return the DeepMind 12 to normal operation.



## 23. Definition of Terms

This glossary provides an explanation of the symbols, terms and abbreviations used in this manual.

**16'/8'/4'** Used to describe the range of an oscillator, this term originates from pipe organs. The length of the pipe is inversely proportional to the pitch it produces e.g. a 4' pipe is one octave higher than an 8' pipe.

**ADC or A/D** Analog to Digital Converter, used to describe the process of signal conversion

**AC** Alternating Current

**ADSR** Attack, Decay, Sustain and Release, an envelope with four stages.

**Aftertouch** - The pressure applied to a key after it has been pressed. This pressure is converted into a MIDI signal to allow the amount of pressure to modulate another parameter.

**Algorithm:** A process or set of rules used to accomplish an operation.

**Amplifier** A circuit which increased the level of a signal.

**Amplitude Modulation (AM)** Modulation of the amplitude (or level) of a sound by another signal source. AM is used to produce tremolo using a low frequency modulation source.

**Analog** Something which is proportional or similar to something else. In the case of the synthesizer, audio electronic circuits are another form of air pressure waves. Analog signals contain distortions from the components, topology, circuits and designs which are often perceived as warmer and more natural than their digitally generated counterparts.

**Arpeggiator** An "Apreggio" is a number of notes played sequentially instead of simultaneously. The Arpeggiator responds to a number of keys being held by playing a sequence of notes. The notes, and their sequence can be configured using the preset modes of operation.

**Attack Time** The first stage of an ADSR envelope, used to control the initial part of a sound. Specified as the duration of time for an envelope to reach the maximum level after it has been triggered on by a key press or gate signal.

**Attenuate** To reduce the level of a signal.

**Automation** The recording and playback of control signals.

**Auto-panning** An effect which cyclically adjusts the position of the audio signal within the stereo field.

**Balanced Audio** A type of audio connection that uses the three wires in a cable as part of a phase-cancelling arrangement to boost the signal and reduce noise.

**Band** A range of frequencies.

**Bandwidth** The difference between the upper and lower frequencies of a filter.

**Bank** A group of programs

**Bass** Lower frequencies in a signal ranging from 60 Hz to 250 Hz (Approximately B1 to B3).

**Beat** Frequency When two waveforms of different frequencies are mixed together the resulting waveform will have points of constructive and destructive interference. The beat frequency is equal to the difference in frequencies and is heard as a "beating" or amplitude modulation.

**Beats Per Minute (BPM)** Used to describe the tempo of a composition by specifying the number of beats which should occur in every minute.

**Cent** Unit of measurement for pitch tuning. There are one hundred cents in a semitone.

**Chorus** An effect which uses multiple copies of a signal played together and slightly out of time, to create a shimmering effect. Sometimes referred to as "Ensemble".

**Clock** A digital waveform typically square which is used as a timing source for other components in a system.

**Comb Filtering** Removal of signal components using a filter shape with a number of regularly spaced frequencies.

**Compressor** A dynamics processor that reduces the level of any signal exceeding a specified threshold volume.

**Continuous Controller** A type of MIDI message assigned to a specific parameter. When the parameter is adjusted a continuous controller messages are sent. If the assigned continuous controller is received then the parameter will be adjusted.

**Control Voltage (CV)** A voltage signal used to control any parameter. Was common on synthesizers before MIDI, and is now found mostly on modular synthesizers.

**Cross-Modulation (X-Mod)** Two oscillators modulating each other at the same time. The outputs is a mix of the sum and difference of the oscillators. The term is also used to describe the ability for parameters of a synthesizer to be able to modulate other parameters.

**Cut-Off Frequency** The frequency which a filter is set to. Beyond this frequency (in a lo-pass filter, the most common), the sound is cut off (attenuated) at a rate set by the slope of the filter response curve.

**Cycle** In a sound wave, the cycle refers to a single repetition of a wave-shape. E.g. in a square waveform it is the time from a positive edge, to the next positive edge.

**DAC or D/A** Digital to Analog Converter, used to describe the process of signal conversion

**Data** Digitally stored information

**dB** Symbol for "decibel". A unit of measurement of the loudness of sound. See dBu.

**dBu** A unit of measurement of sound used in professional audio. Derived from the decibel, where the "u" stands for unloaded, this unit is an RMS measurement of voltage based on 0.775 VRMS, which is the voltage at which you get 1mV of power in a 600 ohm resistor. This used to be the standard impedance in most professional audio circuits.

**DC Offset** An imbalance that sometimes occurs in A/D converters. It is a constant voltage that is present which can eat up headroom and cause clicks and pops during editing.

**Decay Time** The second stage of an ADSR envelope. Specified as the duration of time for an envelope to reach the sustain level after the maximum level has been reached during the attack stage.

**Default** An initial value for parameter, i.e., the value before any changes have been made.

**Delay** An effect by which a reproduction of a signal is played back later than its original. Primarily used for echo, but also is the basis for phasing, flanging, chorus and basic reverb type effects.

**Detuning** The action of adjusting the pitch of an oscillator from a reference point or another oscillator. When oscillators are detuned slightly they will make the output sound "fatter" or "wider". When oscillators are detuned heavily to note intervals it can create harmonies.

**Digital Audio Workstation (DAW)** A computer based recording system. More commonly used to describe the software package used to record, process and mix.

**Digitally Controlled Oscillator** An analog oscillator circuit controlled and monitored by a digital processor. The advantages over a VCO is increased stability which results in far less tuning drift.

**Digital Signal Processing (DSP)** The numerical manipulation of signals, usually with the intention to measure, filter, change, effect, produce or compress continuous analog signals.

**Distortion** An effect based on pushing the boundaries of what a specific technology or implementation can achieve. At the point where technology begins to overload, overdrive, clip, saturate or generally misbehave is where distortion starts to appear. Examples include tape, valve, transistors, and also digital algorithms and processes.

**Dynamic** The range of levels in an audio signal, from the softest to the loudest.

**Dynamic Processor** A device used to control and/or change the dynamics of a signal.

**Dynamic Range** – The difference between the lowest level and the highest level an audio system can produce.

**Edit / Editing** The combined methods of creating a program from a starting point or program.

**Edit Buffer:** A temporary storage memory for a program.

**Effect:** One of a number of audio processes that can be applied to a signal to modify it, such as reverb, flanging, phasing, delay etc.

**Effects Send** A copy of the channel signal which is sent to an effects processor in order for it to be returned.

**Effects Return** An effected audio signal which is returned to mix with the original channel signal.

**Envelope Generator (EG):** An envelope signal which can be adjusted to a specific shape in order to control the way a sound behaves over time.

**Equalisation (EQ)** Processor used to adjust the volumes of various frequency ranges for creative or corrective purposes.

**Exponential** A mathematical function of growth or decay where the independent variable is the exponent. This results in a "hockey stick" shaped curve.

**Expression Pedal** A Pedal which can be connected to an expression input and used to send a control signal dependant on the position of the pedal. The control signal can then be used to modulate other parameters, and/or to add expression.

**Fader** A physical linear control also known as a slider, or slide potentiometer which can be used to adjust a parameter.

**Feedback:** A loop created between an audio input and an audio output of an audio circuit, system or processing block.

**Filter** A device that attenuate certain frequencies while letting other frequencies through. Using a filter to reduce harmonics changes the timbre or color of the sound.

**Flanger** An effect that mixes a slightly delayed copy of the signal with the original signal, producing a linear harmonic comb filter response. The copy's delay time is modulated by an LFO which results in jet-like sounds suitable for sweeps, and can also be used to add metallic type resonance to a sound.

**Frequency Modulation (FM)** Using one frequency to modulate another frequencies pitch. When the modulation source is in the audio range it can be perceived as a change in the timbre or color of the sound. FM can be used to create a wide range of rich and complex sounds and is often described as having a clear and distinctive timbre.

**Frequency:** The number of times that a sound waves cycle repeats within one second.

**Fundamental Frequency** The lowest frequency of a periodic waveform.

**Gain** The amount of signal level increase provided by an amplifier stage.

**Gate (Synthesizer)** A signal used to trigger an event, such as a note or an envelope.

**Gate (Dynamics)** A device used to cut off the level of a signal when it falls below a specified threshold. Can be used to cut background noise, control reverb tails or creatively to produce chopping type effects.

**Glide** - See Portamento

**Globals** The settings and parameters which govern the general operation of the synthesizer and are not directly associated with the voice engines

**Harmonics** A series of integer-related sine waves at varying levels creating different timbres. Waveforms (other than a pure sinusoidal) generate various harmonics which help define the character of the sound.

**Hertz (Hz)** A unit of frequency equal to one cycle of a sound wave per second.

**High Pass Filter (HPF)** A filter that attenuates lower frequencies from a signal, leaving the higher frequencies unaffected.

**Hum** Undesirable low frequency tone present in a signal due to grounding problems or proximity to a power source.

**Impedance (Z)** Opposition to the flow of alternating current in a circuit, measured in ohms.

**Insert** A point in a processing chain where a device can be inserted.

**Keyboard** A range of keys, arranged in order of ascending pitch, which enables the synthesizer to be played by hand.

**Keyboard Tracking** Allows the control signal from played keys to adjust another parameter. Commonly used to open a filter as higher notes are played which then enhances harmonics.

**Kilohertz (kHz):** A unit of frequency equal to one thousand cycles of a sound wave per second.

**Latency:** A delay introduced by processing. Measured by the time it takes to produce a signal after a request has been made. In a synthesizer it is the time taken to produce a note after a key has been played. In an audio interface it is used to measure the time it takes for an input signal to reach the processor, or for a signal from the processor to reach the output.

**Level** Used to describe the magnitude of a sound, often relative to an arbitrary reference.

**Limiter** A device used to limit the level to a range of values irrespective of the input level.

**Linear** Used in audio to describe a straight line response of circuit or process which results in a change which is directly proportional to an independent variable.

**Line Level** A nominal operating level used by audio equipment. Professional line level is normally +4 dBu and consumer line level is -10 dBv.

**Looping** Automatically restarting a function at the end of a period of time or defined cycle to create a continuous loop.

**Low Frequency Oscillator (LFO)** An oscillator that commonly runs at a very low speed and is used to modulate another parameter.

**Low Pass Filter (LPF)** A filter that attenuates higher frequencies from a signal, leaving the lower frequencies unaffected

**Mark to Space Ratio** The ratio between the positive and negative parts of a rectangular waveform, or pulsewave.

**Memory** Digital storage of information/data.

**Meter:** Visual device to indicate the level of a signal.

**MIDI (Musical Instrument Digital Interface)** (A technical standard that describes a protocol, digital interface and connectors and allows a wide variety of electronic musical instruments, computers and other related hardware/software devices to connect and communicate.

**MIDI Clock** A clock signal which is broadcast over MIDI to ensure that devices are synchronised. Also known as MIDI Beat Clock or MIDI Timing Clock.

**MIDI Message** Data or information transmitted from one MIDI device to another. Each MIDI message contains at least two numbers: one that identifies the type of message being sent, and another which represents a value for the selected type of message.

**Midrange** Frequencies in a signal ranging from 250 Hz to 5 kHz (Approximately B3 to D#8).

**Mix** The balance of level between one signal and another.

**Mixer** A device that blends input signals into composite signals for output.

**Modular synthesis** A synthesis system comprised of a number of modules which can be connected in many different ways. Modules can perform a single function such as an oscillator or filter or perform multiple functions.

**Modulation** The process of controlling one or more properties (destinations) of a signal using another signal (source).

**Modulation Matrix:** A matrix which allows the creation of multiple source to destination modulations, each with adjustable levels of operation.

**Modulation Wheel (Mod Wheel)** A wheel located to the left of a keyboard that allows you to change specified parameters in real-time.

**Monitors:** Studio quality loudspeakers, providing an accurate representation of the audio signals.

**Mono:** A single signal.

**Monophonic** Only one note can be played at any given time as there is only a single voice.

**Mute** Function that allows a signal to be silenced.

**N/A** Abbreviation for "not applicable".

**Noise Generator** A circuit or process that produces a random (or aperiodic) signal. The frequency response can differ depending on the type of noise.

**Note-Priority** Determines which note is played when several are held simultaneously.

**Non-Registered Parameter Number (NRPN)** A series of controller change messages used to transmit a parameter change with up to 14-bits of resolution.

**Octave or Oct** Unit of measurement for pitch. Every time the frequency of a waveform doubles, the pitch increases by one octave.

**Ohm ( $\Omega$ )** Unit of electrical resistance.

**Oscillator** An electronic device which generates a periodic signal used to form the basis of a synthesizer program.

**One Shot** A single event that has to be triggered each it is required.

**Output** The signal sent out by a device or process. Also used to describe the physical socket where a signal leaves a device.

**Overtone** Any frequency that is present in a waveform that is higher than the fundamental frequency of that waveform.

**Pad** A program that is usually characterized by slow attack and release times.

**Panning / Pan** The positioning of a signal within a stereo image.

**Parameter:** A setting whose value can be changed.

**Parametric EQ** A type of EQ that allows all of the parameters of equalisation to be changed, including centre frequency, boost/cut in gain and bandwidth.

**Partial** Any of the sinusoidal waveforms which form part of a complex tone.

**Patch** The cables used on modular synthesizers (or synthesizers with modular compatibility) to connect devices together. Patch cables can carry audio, gate or control voltage signals.

**Period** The time that it takes a wave to complete a full cycle. Period is calculated by dividing 1 by the frequency

**Phase:** A measurement (in degrees) of the time difference between two waveforms or between a single waveform and a reference point.

**Phaser** An effect which uses a series of notched all-pass filters (also called stages) to create a comb filter response which does not always have harmonic relationships between the notches. The result is a sweeping effect similar to a flanger but smoother and often more natural sounding.

**Pink Noise** A type of signal that has equal power in each band. Human hearing is roughly logarithmic, therefore each octave is discerned to have an equal amount of power across the audible spectrum.

**Pitch:** A quality of sound that makes is possible to judge if a sound is higher or lower than another.

**Pitch Bend / Pitch Bend Wheel** Controlling the pitch of a note after it has been played.

**Pitch shift** Alteration of pitch or frequency, but without adjusting tempo.

**Pole** A section of a filter stage. The more poles a filter has, the steeper its attenuation slope will be, and the more accurate the filter will be.

**Polyphonic** Capable of playing more than one note at once.

**Polyphony** The number of notes a polyphonic synthesizer can play simultaneously.

**Portamento** An adjustable performance effect that glides or bends the pitch from one note to the next.

**Post** The point for accessing audio just after it leaves a specific component or stage.

**Pre** The point for accessing audio just before it reaches a specific component or stage.

**Preset:** A program or part of a program that is built into a synthesizer patches that are sometimes fixed and sometimes editable.

**Program** A complete set of parameters and settings which the synthesizer uses to create the a specific sound.

**Power Supply Unit (PSU)** The component in a system which is responsible for supplying and managing power.

**Psychoacoustics** The study of the perception of sound, that is, how we listen, our psychological responses and the physiological effects on the human nervous system.

**Pulse Wave** Similar to a square wave, but without symmetry. Also known as a "Rectangle Wave"

**Pulse Width Modulation (PWM)** Modulation of the pulse width (the duty cycle of a pulse wave measured as a percentage). A pulse width of 50% has equal positive and negative sections and is considered a square wave.

**Q Factor** A bandwidth (or selectivity), of a particular band in an equalizer. The higher the Q Factor, the wider the bandwidth.

**Rate** The speed at which a particular device is operating at.

**Release Time** The fourth and final stage of an ADSR envelope. Specified as the duration of time for an envelope to reach zero after the played key is released.

**Resonance** The emphasis of frequencies around the cut-off point just before attenuation starts to occur. As resonance increases it will reach a point where the filter will start to OSCillate, producing a signal even when there is no input.

**Reverb** An effect where the ambience of a physical space is simulated.

s Symbol for "second". A unit of time.

**Sample Rate** The number of digital samples used every second to represent an analog waveform.

**Sample Resolution (Bit Depth)** The number of digital bits used to define the amplitude of an analog signal. Higher resolution results in greater dynamic range.

**Sawtooth** A waveform that combines an instantaneous rise or fall, followed by a gradual linear incline or decline. The name comes from the waveforms similarity to the teeth of a saw.

**Semitone** A chromatic half-step. There are twelve semitones in an octave.

**Sequencer** A programmable device or module used to arrange/sequence timed events into musical patterns and songs.

**Self-oscillation** Occurs when the resonance of a filter is increased to the point where it will begin to generate a sine wave independently of any input.

**Signal flow:** The path of a signal from one module (or component of a system) to another.

**Sinusoidal / Sine Wave** Mathematical description of a smooth waveform that contains only the fundamental frequency and has no additional harmonics. The shape resembles the letter S rotated 90 degrees.

**Slew Rate** The rate of change of a voltage or control signal.

**Spectrum** First used to describe the full range of colors in visible light the term is also used to describe the full range of frequencies in the audio spectrum.

**Square Wave** A symmetrical waveform that combines an instantaneous rise or fall, followed by a positive or negative steady state. The name comes from the waveforms similarity to a square..

**Step** A step is one stage in a sequence and can be a control signal, single note, chord or rest.

**Stereo / Stereophonic** The most common method of sound reproduction where separate channels, left and right, used to give the impression of direction.

**Stereo-Field / Stereo Image** A virtual space created by stereo loudspeakers/monitors.

**Sub-Bass** Frequencies in a signal ranging from 10 Hz to 60 Hz (Lower than C0 to approximately B1).

**Subtractive synthesis** A technique of creating sounds by filtering waveforms which are rich in harmonics

**Sustain Level** The third stage of an ADSR envelope. Specified as the level an envelope will return to after the decay stage. The envelope will remain at the sustain level until the played key is held.

**Sustain Pedal** A Pedal containing a switch which can be connected to an sustain input and used to send a control signal dependant on the state of the switch (On/Off). The control signal can then be used to modulate other parameters, and/or to add expression.

**Synchronisation (Sync):** Coordination of timing between devices.

**Sync (Tempo)** A function where an cyclical event such as an LFO is synchronised to a tempo value.

**Sync (Oscillator)** A function where one oscillator is synchronised to another. The waveform of the slave oscillator is reset whenever the waveform of the master oscillator restarts.

**Sync (Arp/Seq)** A function where an arpeggiator or sequencer is synchronised to a tempo value.

**Sync (Key)** A function where an event is synchronised to the pressing of a key.

**System Exclusive (SysEx)** messages are multi-byte message used to transfer a complete program or globals. Come in the form of request - response. Threshold: Level at which dynamics processing will begin to operate.

**Tempo** The speed at which a composition should be played, usually expressed in beats per minute.

**Threshold** In dynamic effects, this is the level that must be passed before the processing is engaged.

**Timbre** The tone, character, or aesthetic qualities of a sound.

**Transposition / Transpose:** A function that allows you to shift the entire keyboard up and down in pitch.

**Treble:** Frequencies in a signal ranging from 5 kHz to 20 kHz (Approximately D#8 to above C10).

**Tremolo** A periodic change in amplitude.

**Triggering** - Activation of a function. E.g. the start of a note, envelope, LFO etc.

**Tune / Tuning** The process of adjusting the root pitch of the instrument to a specific reference frequency.

**Unbalanced audio:** A type of audio connection that uses two wires in a cable and does not offer the noise rejection qualities of a balanced system.

**Unison** Two or more voices that are playing together at roughly the same pitch.

**Universal Serial Bus (USB):** A "plug and play" interface that provides a fast connection between a computer and peripherals.

**Volt (V):** A unit of electrical potential differential or electromotive force. A difference in charge between two points in a circuit. This difference, when combined with the rate of the charge (current) allows for the control of many analog circuits that "synthesise" sound.

**Voltage Controlled Amplifier (VCA)** An amplifier whose resultant magnitude is controlled by a voltage.

**Voltage Controlled Filter (VCF)** A filter whose cut-off frequency can be controlled by a voltage.

**Voltage Controlled Oscillator (VCO)** An oscillator whose cut-off frequency can be controlled by a voltage. Typically creates the possibility of tuning drift when used in a synthesizer.

**Velocity** The speed at which a key is pressed. The velocity is converted into a MIDI signal to allow the amount of pressure to modulate another parameter.

**Velocity Sensitivity** A keyboards ability to change the MIDI velocity message to scale key presses before use for modulation.

**Vibrato** A periodic change in pitch.

**Voice:** A physical embodiment of a complete set of OSC, Envelopes, LFOs and VCF which can play a single note. Multiple voices can be stacked together playing the same note in unison modes or assigned to different notes in polyphonic mode.

**Waveform** A repeating signal typically created by an oscillator. A waveform can also be random in the case of noise.

**Wavelength** The shortest distance between two successive points on a wave that are in phase. When used in audio or acoustics the physical wavelength is calculated by dividing the velocity of sound in air (approximately 340m/s) by the waveform frequency.

## 24. Appendix 1 - Octave Shifting

The diagram illustrates octave shifting on a piano keyboard. The keyboard is labeled with notes  $c^0$  through  $c^8$ , with  $c^4$  identified as Middle C. Arrows indicate shifts of -2, -1, +1, and +2 octaves. A musical staff above shows the corresponding notes on a grand staff.

## 25. Appendix 2 - ARP/SEQ/LFO Sync Timing

**ARP/SEQ/LFO SYNC TIMING**

The diagram shows sync timing for ARP/SEQ/LFO. It features a grid with 5 columns and various note types (Straight, Triplet, Dotted) represented by different symbols. A legend at the bottom identifies the symbols.

RATIO	DESCRIPTION
1	One bar
1/2	Half note
3/8	Dotted quarter note
1/3	Third note (Half note triplets)
1/4	Quarter note
3/16	Dotted eighth note
1/6	Sixth note(Quarter note triplets)
1/8	Eighth note
3/32	Dotted sixteenth note
1/12	Twelfth note (Eighth note triplets)
1/16	Sixteenth note
3/64	Dotted thirty-second note
1/24	Twenty-fourth note (Sixteenth note triplets)
1/32	Thirty-second note
3/128	Dotted sixty-fourth note
1/48	Forty-eighth note (Thirty-second note triplets)
1/64	Sixty-fourth note

Legend:  
 ■ Straight Notes  
 ■ Triplet Notes  
 □ Dotted Notes

# FEDERAL COMMUNICATIONS COMMISSION COMPLIANCE INFORMATION



Responsible Party Name: **MUSIC Group Services NV Inc.**  
Address: **5270 Procyon Street  
Las Vegas, NV 89118  
USA**  
Phone Number: **+1 702 800 8290**

## DeepMind 12

complies with the FCC rules as mentioned in the following paragraph:

This equipment has been tested and found to comply with the limits for a Class B digital device, pursuant to part 15 of the FCC Rules. These limits are designed to provide reasonable protection against harmful interference in a residential installation. This equipment generates, uses and can radiate radio frequency energy and, if not installed and used in accordance with the instructions, may cause harmful interference to radio communications. However, there is no guarantee that interference will not occur in a particular installation. If this equipment does cause harmful interference to radio or television reception, which can be determined by turning the equipment off and on, the user is encouraged to try to correct the interference by one or more of the following measures:

- Reorient or relocate the receiving antenna
- Increase the separation between the equipment and receiver
- Connect the equipment into an outlet on a circuit different from that to which the receiver is connected
- Consult the dealer or an experienced radio/TV technician for help

This device complies with Part 15 of the FCC rules. Operation is subject to the following two conditions:

- (1) this device may not cause harmful interference, and
- (2) this device must accept any interference received, including interference that may cause undesired operation.

### Important information:

Changes or modifications to the equipment not expressly approved by MUSIC Group can void the user's authority to use the equipment.

### FCC RF Radiation Exposure Statement:

1. This Transmitter must not be co-located or operating in conjunction with any other antenna or transmitter.
2. This equipment complies with FCC RF radiation exposure limits set forth for an uncontrolled environment. This equipment should be installed and operated with a minimum distance of 50 mm between the radiator and your body.

Dedicate Your Life to MUSIC